

A

Turning

B

Milling

C

Drilling

D

Technical Information

E

Index

SNMG	L	I.C	S	d
09 03	9.525	9.525	3.18	3.81
12 04	12.7	12.7	4.76	5.16
15 06	15.875	15.875	6.35	6.35
19 06	19.05	19.05	6.35	7.94

- Ideal machining conditions
- ⊗ Normal machining conditions
- ⊗ Unfavourable machining conditions

Turning inserts

SN** negative insert				HC ¹ (CVD)								HC ¹ (PVD)		HT	HC ²	HW												
ISO	r	a _p	f	P	M	K	N	S	H																			
				YBC103	YB6315	YBC152	YBC203	YBC252	YBC352	YBM153	YBM253	YBD102	YB7315	YBD152	YBD152C	YBG101	YBG102	YBG105	YBG205	YB9320	YPD201	YBS103	YNG151	YNT251	YNG151C	YD101	YD201	
PM  Medium Cut	SNMG090304-PM	0.4	0.4-4.5	0.1-0.3																								
	SNMG090308-PM	0.8	0.5-4.5	0.15-0.50																								
	SNMG090312-PM	1.2	0.6-4.5	0.2-0.6																								
	SNMG120404-PM	0.4	0.4-6.0	0.1-0.3																								
	SNMG120408-PM	0.8	0.5-6.0	0.15-0.50																								
	SNMG120412-PM	1.2	0.8-6.0	0.18-0.60																								
	SNMG120416-PM	1.6	1-6	0.23-0.65																								
	SNMG150608-PM	0.8	0.7-7.5	0.14-0.50																								
	SNMG150612-PM	1.2	0.8-7.5	0.18-0.60																								
	SNMG190612-PM	1.2	1.0-7.5	0.20-0.65																								

● Ex stock ○ On demand
 YBC152F, YBC252F, YBM153F, YBM253F available

HC¹ Coated carbide
 HT Uncoated cermet
 HC² Coated cermet
 HW Uncoated carbide

Tool holder

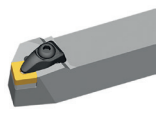
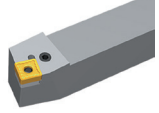
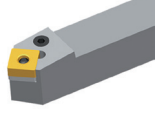
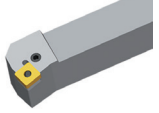
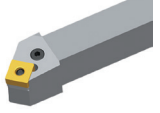
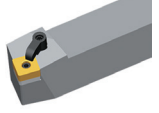
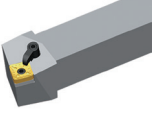
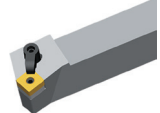
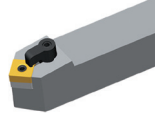
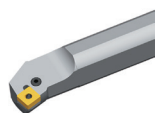
DSBNR/L	PSBNR/L	PSDNN	PSKNR/L	PSSNR/L	MSBNR/L	MSRNR/L
Kr: 75°	Kr: 75°	Kr: 45°	Kr: 75°	Kr: 45°	Kr: 75°	Kr: 75°
						
A232	A242	A244	A245	A246	A256	A257
MSKNR/L	MSDNN	S***-PSKNR/L				
Kr: 75°	Kr: 45°	Kr: 75°				
						
A258	A259	A329				



ISO standard

T N M G 22 04 08 (N) – DM

1 2 3 4 5 6 7 8 9

Insert shape		
A	B	C
D	E	H
K	L	M
O	P	R
S	T	V
W	Z Special	

Clearance angle	
A	B
C	D
E	F
G	N
P	O Special

Tolerance class			
Code	I.C [mm]	m [mm]	S [mm]
A	±0,025	±0,005	±0,025
C	±0,025	±0,013	±0,025
E	±0,025	±0,025	±0,025
F	±0,013	±0,005	±0,025
G	±0,025	±0,025	±0,130
H	±0,013	±0,013	±0,025
J	±0,05–0,15	±0,005	±0,025
K	±0,05–0,15	±0,013	±0,025
L	±0,05–0,15	±0,025	±0,025
M	±0,05–0,15	±0,08–0,20	±0,130
N	±0,05–0,15	±0,08–0,20	±0,025
U	±0,08–0,25	±0,13–0,38	±0,130

1

2

3

Fastening features (metric)	
Insert shape	
A	B
C	F
G	H
J	M
N	Q
R	T
U	W
X Special	

Cutting edge length l [mm]								
I.C [mm]	Insert shape							
	C	D	R	S	T	V	W	K
3,97	06							
5,0	05							
5,56	09							
6,0	06							
6,35	06	07			11	11		
8,0	08							
9,525	09	11	09	09	16	16	06	16
10,0	10							
12,0	12							
12,7	12	15	12	12	22	22	08	
15,875	16		15	15	27			
16,0	19							
19,05	19		19	19	33			
20,0	20							
25,0	25	25	25					
25,4	25							
31,75	31							
32	32							

4

5

Insert thickness S [mm]			
Code	S	Code	S
00	0,79	T5	5,95
T0	0,99	06	6,35
01	1,59	T6	6,75
T1	1,98	07	7,94
02	2,38	09	9,52
T2	2,58	T9	9,72
03	3,18	11	11,11
T3	3,97	12	12,70
04	4,76		
T4	4,96		
05	5,56		

6

Nose radius r [mm]	
Code	r
00	–
02	0,2
04	0,4
08	0,8
12	1,2
16	1,6
20	2,0
24	2,4
32	3,2
X	Special
MO	Round inserts

7

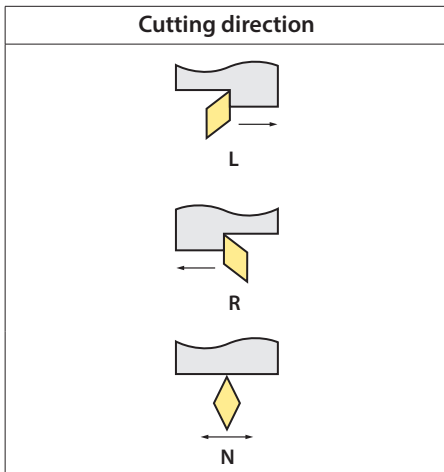

8

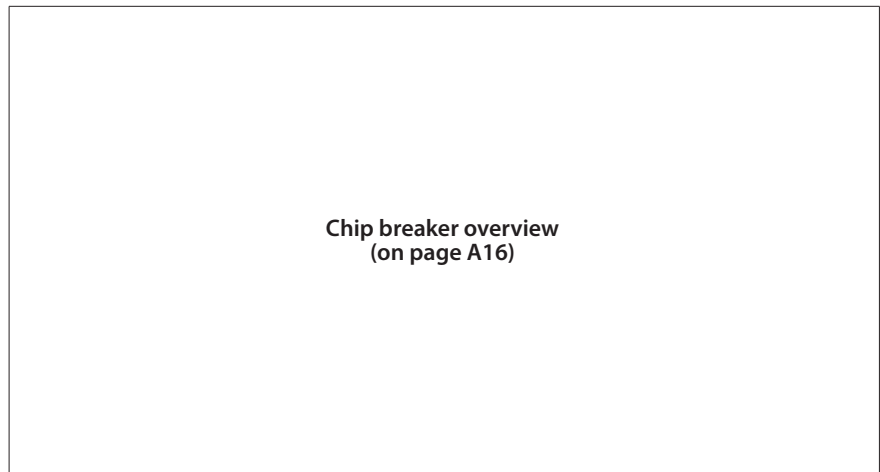

9

ANSI standard

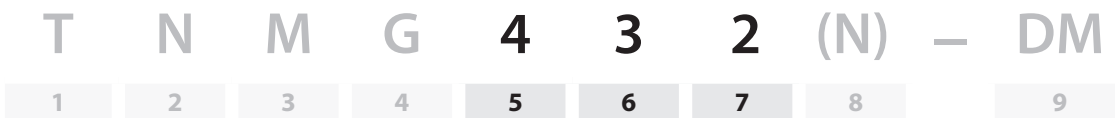

Inner circle		
Code	[mm]	Pouce
2	6.35	0.250
3	9.525	0.375
4	12.7	0.500
5	15.875	0.625
6	19.05	0.750
8	25.4	1.000

5

Insert thickness		
Code	[mm]	Pouce
2	3.18	0.125
3	4.76	0.187
4	6.35	0.250
5	7.94	0.313
6	9.52	0.375

6

Nose radius		
Code	[mm]	Pouce
0	0.2	0.008
1	0.4	0.016
2	0.8	0.031
3	1.2	0.047
4	1.6	0.063
5	2.0	0.079
6	2.4	0.094

7

A

Turning

Negative inserts

Medium machining



Double sided chip breaker for medium machining. Wide range of application due to excellent balance of sharpness and cutting edge stability.

B

Milling

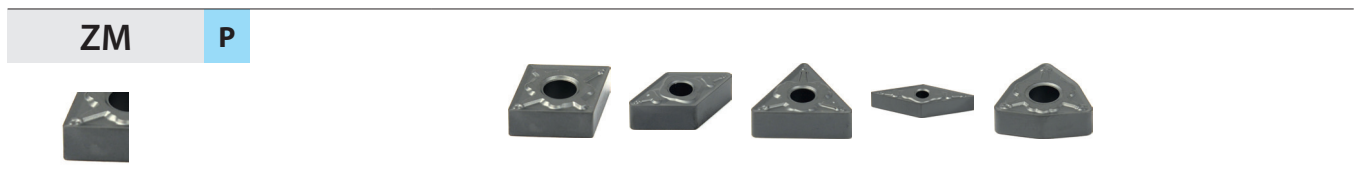

Double sided chip breaker for medium machining. Wide range of application due to stable cutting edge and large rake angle. Very suitable for machining of steel.

C

Drilling



Double sided chip breaker for medium machining. Wide range of application in steel and cast iron.

D

Technical Information

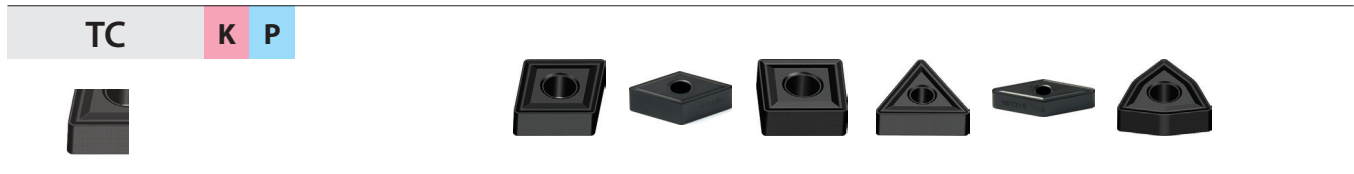

Double sided chip breaker with surrounding cutting edge. Process reliable machining due to highest cutting edge stability.

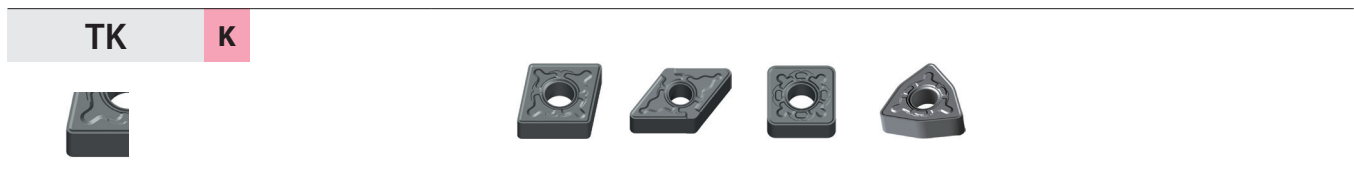

Double-sided chip breaker for medium machining operations in the K application field. Optimum combination of impact resistance and cutting edge sharpness.

E

Index

General turning

Application fields of chip breakers

Example

Insert: CNMG120408-DF
 Holder: PCLNL2525M12
 Material: C45 steel
 V_C : 200 m/min

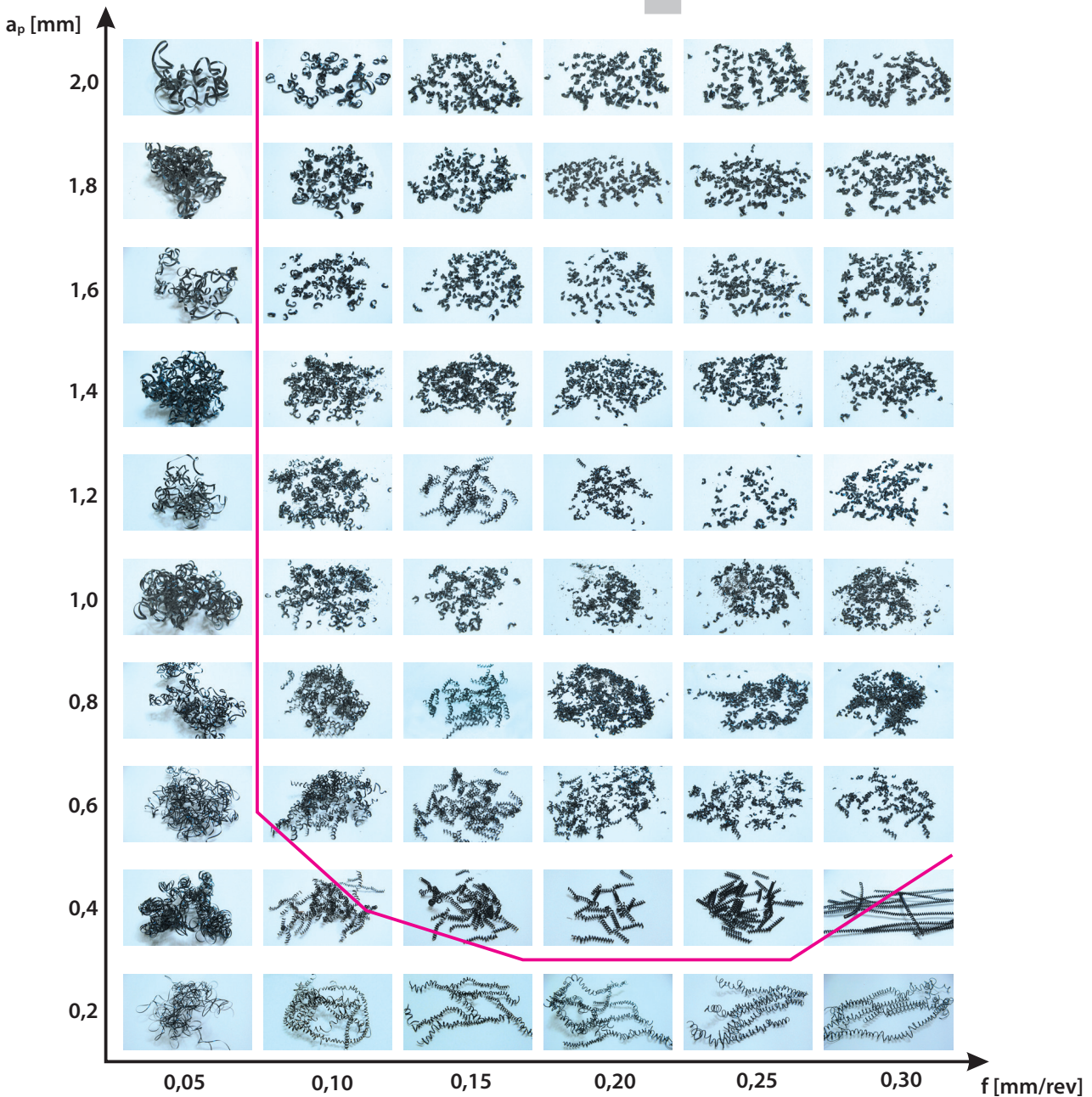
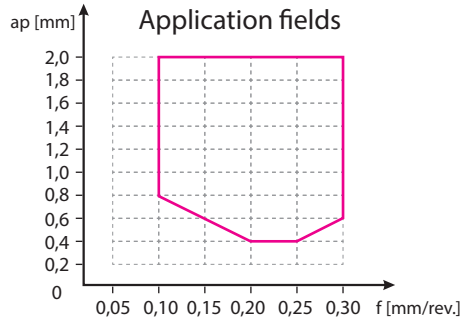

A

Turning

B

Milling

C

Drilling

D

Technical Information

E

Index

P Negative inserts

Chip breaker	Application	Application fields	Cutting edge design
SF	Fine-finishing		
DF	Finishing		
XF	Finishing		
ADF	Finishing		
DM	Medium machining		
PM	Medium machining		
ZM	Medium machining		
XM	Medium machining		
WG	Medium machining		
Basic	Medium machining		
DR	Roughing		

A

Turning

B

Milling

C

Drilling

D

Technical Information

E

Index

Coated cemented carbide CVD

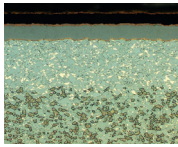
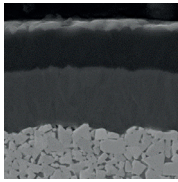
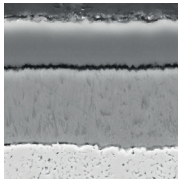
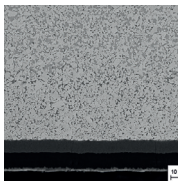
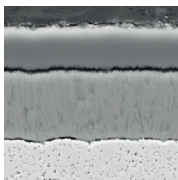
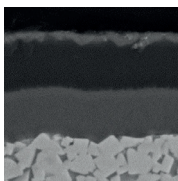
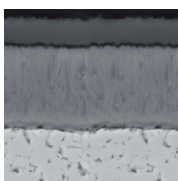
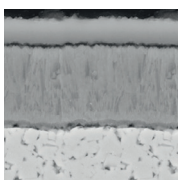
Grade	ISO	Micro structure	Grade description
A Turning	YBC103	P05 – P15 	P10 grade with excellent wear resistance at higher cutting speeds. Latest sinter processes and CVD coating technologies enable a wide range of applications in the P material range.
	YB6315	P05 – P20 	CVD coated P10–P20 carbide grade for finishing to medium operation of steel, casting steel and high chrome material. Outstanding performance under high cutting speed and temperature with excellent wear resistance.
B Milling	YBC152	P10 – P20 	CVD coated P10–P20 carbide grade for finishing to medium operation of steel and casting steel. Outstanding performance under higher cutting speed and temperature with excellent wear resistance.
	YBC203	P15 – P25 	P20 grade with exceptional wear resistance and toughness for reliable machining operations. Ultra-modern sintering technique and CVD coating technologies allow for a wide range of applications in the P material range.
C Drilling	YBC252	P20 - P35 	CVD coated P20–P35 carbide grade for medium operation to roughing of steel and casting steel. Optimal performance of wear resistance and toughness for a wide application field.
	YBC352	P20 - P40 	CVD coated P20–P40 carbide grade for roughing operation of steel and casting steel. Optimal performance of wear resistance and toughness for a wide application field.
D Technical Information	YBM153	M10 - M25 	CVD coated M10–M25 carbide grade for finishing to medium application in stainless steel. High wear resistance and capability against plastic deformation at higher cutting speed.
	YBM253	M15 - M35 	CVD coated M15–M35 carbide grade for medium to roughing operation in stainless steel with wide application field. High wear resistance and capability against plastic deformation at higher cutting speed.
E Index			

Coated cemented carbide CVD

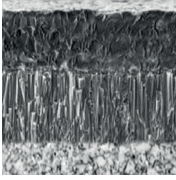
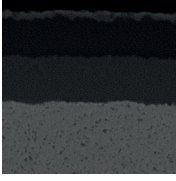
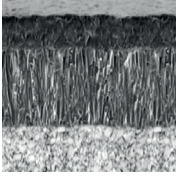
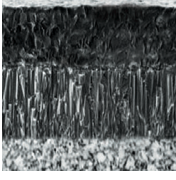
Grade	ISO	Micro structure	Grade description
YBD102	K05 - K20		CVD coated K05-K20 carbide substrate. Optimized for medium operation of cast iron, special nodular cast iron and hard steel at high cutting speed.
YB7315	K10 - K25		CVD coated K10-K25 carbide substrate. Optimized for medium to roughing operation of cast iron. Improved wear resistance and toughness at high cutting speed.
YBD152	K10 - K25		CVD coated K10-K25 carbide substrate. Optimized for medium to roughing operation of cast iron. Good wear resistance and toughness at higher cutting speed.
YBD152C	K10 - K25		Thick Al ₂ O ₃ CVD coated K05-K25 carbide substrate. Optimized for medium to roughing operation of cast iron. Higher wear resistance and toughness at higher cutting speed in combination with TC chip breaker.

Coated cemented carbide PVD

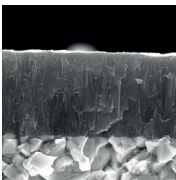
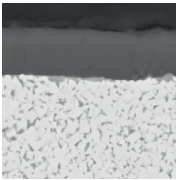
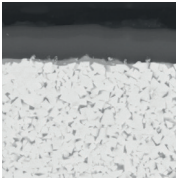
Grade	ISO	Micro structure	Grade description
YBG101	N05 - N20		PVD coated N05-N20 carbide substrate for finishing to semi-finishing in aluminium materials. Coating only on the top face, in combination with the aluminium chip breakers, prevents built-up edges and gives a smooth cut.
YBG102	S05 - S15		PVD coated S05-S15 carbide substrate for finishing to medium application of super alloy material, stainless steel and aluminum. Good wear resistance in a wide application field.
YBG105	S05 - S20		PVD multilayer coated S05-S20 carbide substrate for finishing to medium application of super alloy material but also stainless steel. Good wear resistance and thermal stability in a wide application field.

A

Turning

B

Milling

C

Drilling

DTechnical
Information**E**

Index

Coated cemented carbide PVD

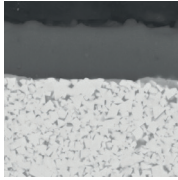
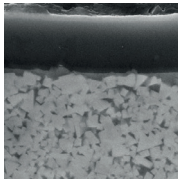
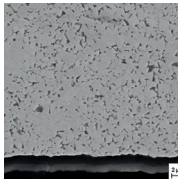
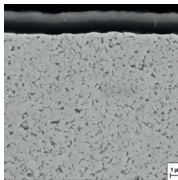
Grade	ISO	Micro structure	Grade description
YBG205	P10 - P30 M20 - M40 S15-S25		PVD multilayer coated P10–P30/M20–M40/S15–S25 carbide substrate for finishing to medium machining of stainless steel, super alloys and steel (milling). Excellent wear resistance and thermal stability in a wide range of applications.
YB9320	P10 - P30 M10 - M25		PVD multilayer coated P10–P30/M10–M25 carbide substrate for finishing to medium machining of stainless steel, super alloys and steel (grooving/milling). Optimised coating stability for higher wear resistance and thermal stability in a wide range of applications.
YPD201	S20 - S30		Carbide grade for semi-roughing to chip breaking of high-strength and high-alloy materials. High-performance grade with high wear resistance. Balanced hardness and internal stress ratio provide a wide range of applications.
YBS103	S10 - S20		Turning grade for processing nickel-base materials. A special carbide substrate and the latest PVD coating technology enable a very good wear behaviour and high thermal stability.

Ceramic

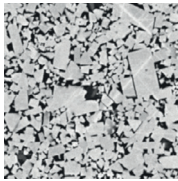
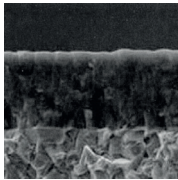
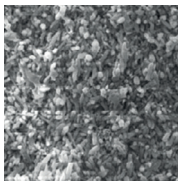
Grade	ISO	Micro structure	Grade description
CA1000	K10 - K25 H10 - H25		Uncoated H10–H25/K10–K25 mixed ceramic grade for finishing to medium operation in hardened steel and nodular cast iron. Good wear resistance and toughness.
CM1000	K10 - K25 H10 - H25		Coated H1–H25/K10–K25 mixed ceramic grade for finishing to medium operations in hardened steel, tool steel, HSS material and nodular cast iron. Good wear resistance and toughness.
CN1000	K05 - K15		Uncoated K05–K15 Si ₃ N ₄ ceramic grade for finishing to medium operation in grey cast iron. Good wear resistance and thermal stability.

Ceramic

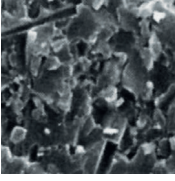
Grade	ISO	Micro structure	Grade description
CS1000	S05 – S20		Uncoated SiAlON ceramic grade for medium machining to roughing of nickel- and cobalt-based alloys at medium to low cutting speeds.
CW1400	S10 – S20 H10-H20		Uncoated whisker ceramic grade for medium and low speed cutting in HSS steel, high chrome steel and cobalt-base alloy also with interrupted cut. Good wear resistance, notch wear resistance and thermal stability.
CW1800	S10 – S25		Uncoated whisker ceramic grade for finishing to rough operations in Ni-base alloy material like Inconel, Nimonic or Hastelloy. Good wear resistance, notch wear resistance and thermal stability.

Uncoated cemented carbide

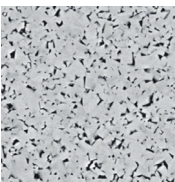
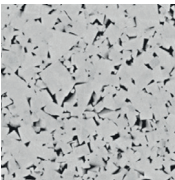
Grade	ISO	Micro structure	Grade description
YD101	N05 - N20 K05 - K20		Uncoated N05–N20/K05–K20 carbide substrate for fine to medium application in aluminum and other material.
YD201	N10 - N30 K10 - K30		Uncoated N10–N30/K10–K30 carbide substrate for medium application in aluminum and other material.

CBN

Grade	ISO	Micro structure	Grade description
YCB112	S10 – S20		Uncoated, brazed S10–S20 CBN grade for fine finishing operations on hardened steel and super alloys. Excellent wear resistance and thermal stability.

A

Turning

B

Milling

C

Drilling

DTechnical
Information**E**

Index

A	Turning
B	Milling
C	Drilling
D	Technical Information
E	Index

CBN

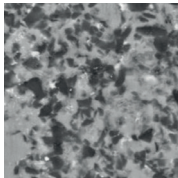
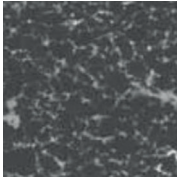
Grade	ISO	Micro structure	Grade description
YCB113	H01 - H10		Uncoated, brazed H01–H10 CBN grade for fine finishing operation in hardened steel with continuous cut. High wear resistance and productivity at higher cutting speed.
YCB121	H10 - H25		Uncoated, brazed H10–H25 CBN grade for fine to medium application in hardened steel from continuous to light interrupted cut. Good wear resistance and toughness for universal use.
YCB131	H20 - H35		Uncoated, brazed H20–H35 CBN grade for fine to medium application in hardened steel with interrupted cut. Good wear resistance and optimized toughness for safe process.
YCB113C	H01 - H10		Coated, brazed H01–H10 CBN grade for fine finishing operations on hardened steel with a continuous cut. High wear resistance and productivity at higher cutting speeds
YCB121C	H10 - H25		Coated, brazed H10–H25 CBN grade for fine to medium machining operations on hardened steel with a continuous to partially interrupted cut. Good wear resistance and toughness for universal application.
YCB131C	H20 - H25		Coated, brazed H20–H35 CBN grade for fine to medium machining operations on hardened steel with an interrupted cut. Good wear resistance and optimum toughness for reliable operations.
YCB215	K10 - K20		Uncoated, brazed K10–K20 CBN grade for fine to medium machining operations on cast iron. Excellent wear resistance and thermal conductivity.
YZB630	H20 - H30		Uncoated H20–H30 solid CBN grade for medium machining operations on hardened steel with a slight to medium interrupted cut. Excellent combination of wear resistance and thermal stability.

CBN

Grade	ISO	Micro structure	Grade description
YZB630C	H20 - H30		Coated H20–H30 solid CBN grade for medium machining operations on hardened steel with a slight to medium interrupted cut. Excellent combination of wear resistance and thermal stability.

YZB223	K10 - K25		Uncoated H10–H25/K10–K25 mixed ceramic grade for finishing to medium operation in hardened steel and nodular cast iron. Good wear resistance and toughness.
---------------	-----------	--	---

PCD

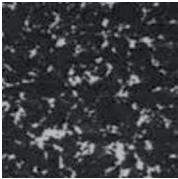
Grade	ISO	Micro structure	Grade description
YCD421	N01 - N10		Uncoated, brazed N01–N10 PCD grade for fine finishing operation of aluminum alloys less than 12 % Si, composites, copper/magnesium and other alloys. Medium grain size grade with good wear resistance for a wide application field.

Cermet

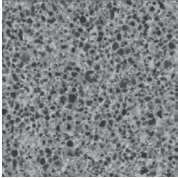
Grade	ISO	Micro structure	Grade description
YNG151	P05 - P15		Uncoated P05–P15 cermet grade for fine finishing operation of steel and stainless steel. Good resistance against plastic deformation for good surface finishing.

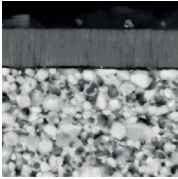
YNG151C	P05 - P15		PVD coated P05–P15 cermet grade for fine finishing operation of steel and stainless steel. Good wear resistance and capability against plastic deformation for good surface roughness.
----------------	-----------	---	--

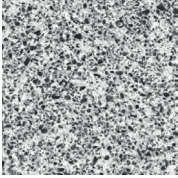
YNT251	P10 - P25		Uncoated P10–P25 cermet grade for fine finishing to medium operation of steel and stainless steel. Good wear resistance and toughness. Suitable also in light interrupted cut.
---------------	-----------	---	--

A

Turning

B

Milling

C

Drilling

DTechnical
Information**E**

Index

CVD coated carbide grades for steel

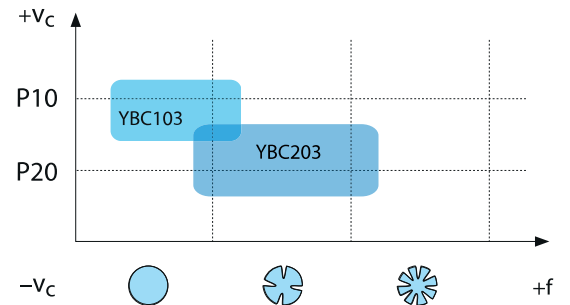
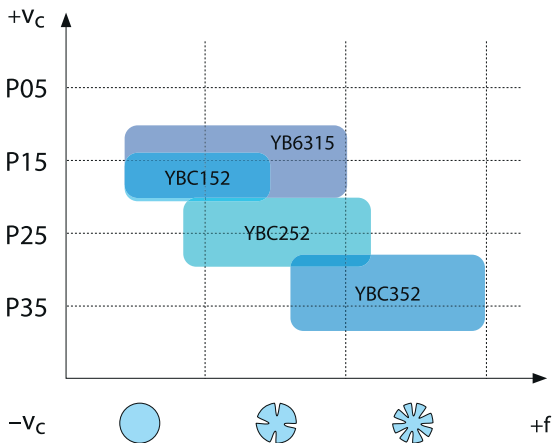

Cermet grades for steel

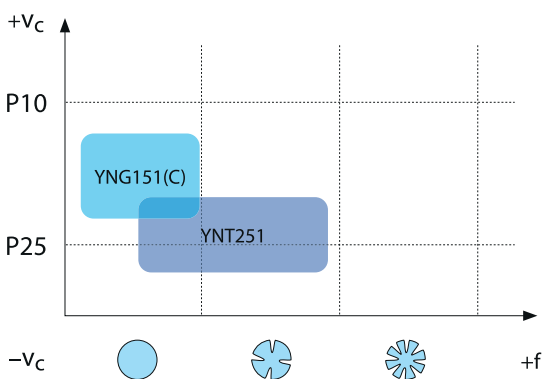

CVD coated carbide grades for stainless steel

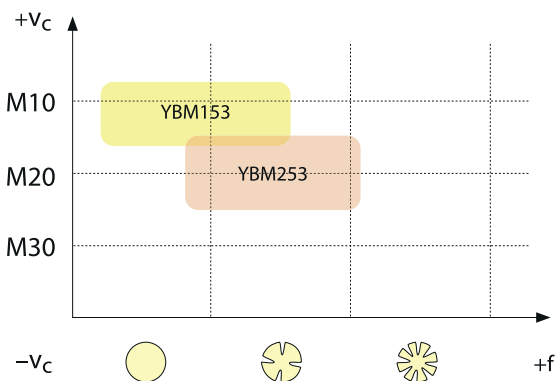

A

Turning

B

Milling

C

Drilling

D

Technical Information

E

Index

PVD coated carbide grades for stainless steel

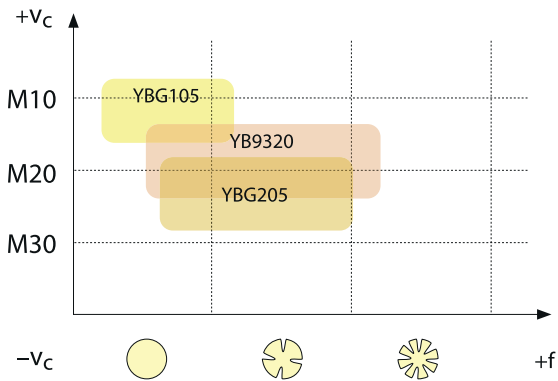

CVD coated carbide grades for cast iron

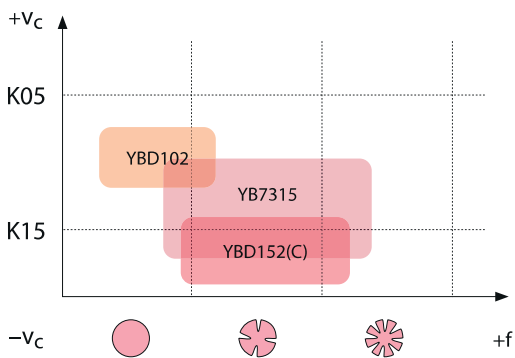

CBN grades for cast iron

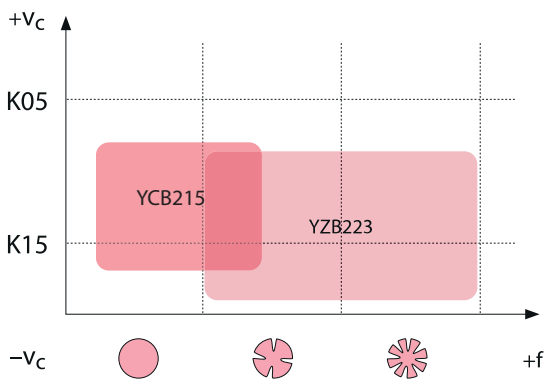

A

Turning

B

Milling

C

Drilling

D

Technical Information

E

Index

A

Turning

Ceramic grades for cast iron

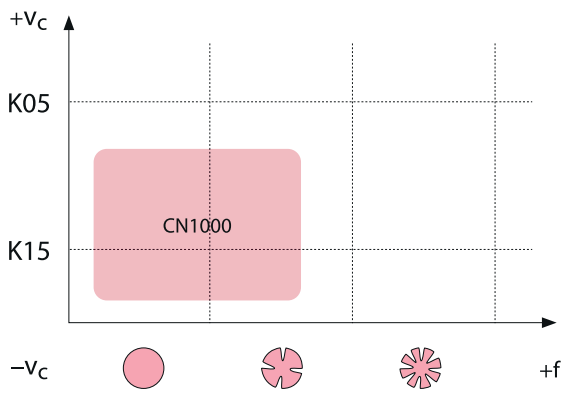

B

Milling

PVD coated carbide grades for superalloys

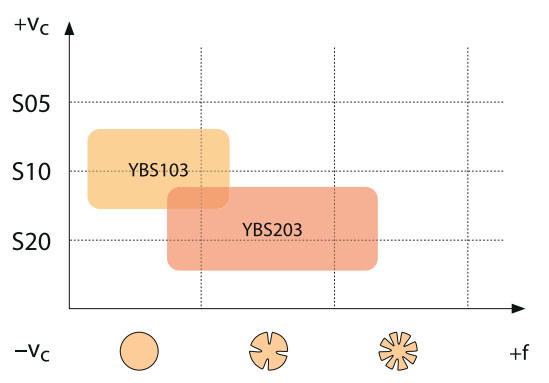
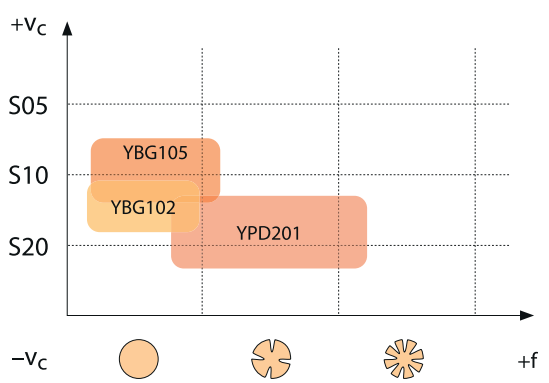

C

Drilling

D

Technical Information

Ceramic grades for cobalt base alloys/HSS

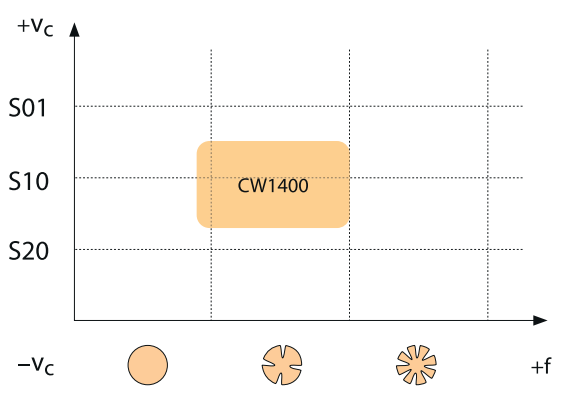

E

Index

Ceramic grades for nickel base alloys

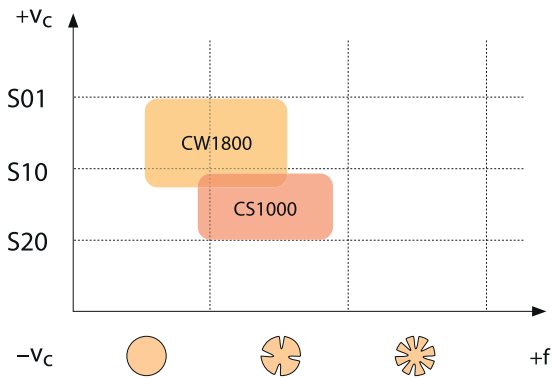

CBN grades for superalloys

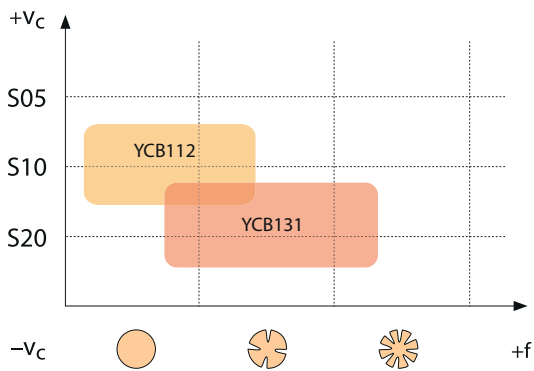

Carbide grades for non-ferrous metals

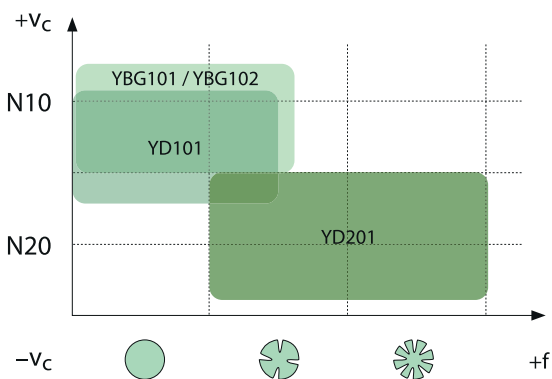

A

Turning

B

Milling

C

Drilling

D

Technical
Information

E

Index

A

Turning

PCD grades for non-ferrous metals

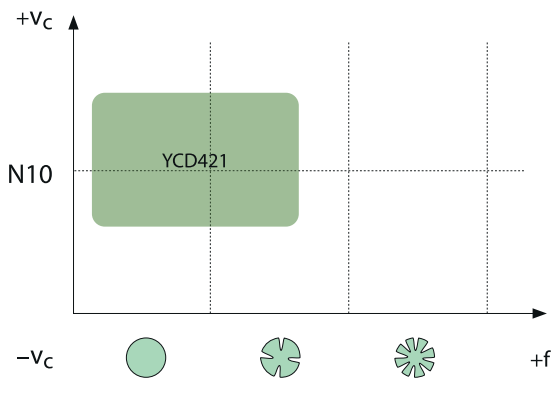

B

Milling

CBN grades for hardened steel

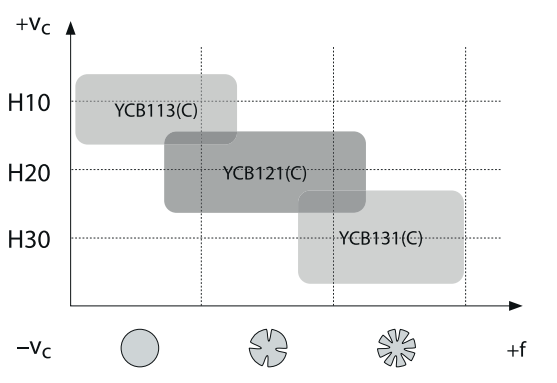

C

Drilling

D

Technical Information

Ceramic grades for hardened steel

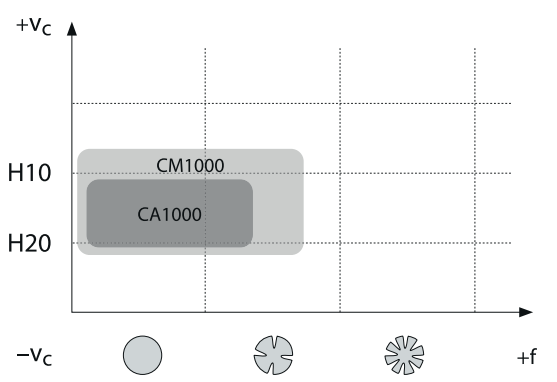

E

Index

Application fields of grades – general turning

	ISO	HC ¹ (CVD)	HC ¹ (PVD)	HT	HC ²	Ceramic	HW	CBN	PCD
P	P01								
	P10	YBC103 YB6315		YNG151	YNG151C				
	P20	YBC152 YBC203		YNT251					
	P30	YBC252							
	P40	YBC352							
M	M01		YBG105	YNG151	YNG151C				
	M10	YBM153	YB9320						
	M20	YBM253	YBG205						
	M30								
	M40								
K	K01					CN1000		YCB215 YZB223	
	K10	YBD102					YD201		
	K20	YBD152							
	K30	YB7315 YBD152C							
N	N01								
	N10		YBG101				YD101		YCD421
	N20		YBG102				YD201		
	N30								
S	S01		YBS103			C51000		YCB112	
	S10		YBG102			CW1400 CW1800		YCB131	
	S20		YBG105						
	S30		YB9320 YPD201						
H	H01								
	H10							YCB113(C) YCB121(C)	
	H20								
	H30							YCB131(C)	

P	Steel
M	Stainless steel
K	Cast iron

N	Non-ferrous metals
S	Heat-resistant alloys
H	Hardened materials

HC¹ Coated carbide
 HT Uncoated cermet
 HC² Coated cermet
 HW Uncoated carbide

A

Turning

B

Milling

C

Drilling

D

Technical Information

E

Index