

Slot milling

SMP03 Kr: 90°

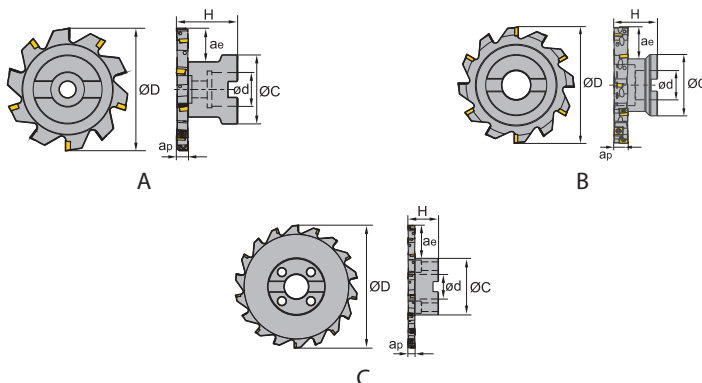

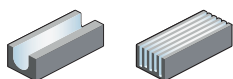



Article	* Stock	Dimensions [mm]							Teeth	Coupling	kg	Inserts
		ØD	ød	Øc	H	ap	ae,max					
SMP03-080x8-A22-MP06-10	○	80	22	45	40	8	21	10	A	0.4	MPHT0603	
SMP03-100x8-B27-MP06-14	○	100	27	55	40	8	24.5	14	B	0.6		
SMP03-100x10-B27-MP06-14	●	100	27	55	40	10	24.5	14	B	0.7		
SMP03-125x10-B32-MP06-16	○	125	32	65	45	10	33.3	16	B	1.1	MPHT0803	
SMP03-125x12-B32-MP08-12	○	125	32	65	45	12	33	12	B	1.4		
SMP03-160x12-B40-MP08-14	○	160	40	80	50	12	44	14	B	1.9		
SMP03-200x12-C40-MP08-18	○	200	40	92	50	12	52	18	C	3.2	MPHT1204	
SMP03-125x16-B32-MP12-10	○	125	32	65	50	16	33	10	B	2.3		
SMP03-160x16-B40-MP12-12	○	160	40	80	60	16	45	12	B	2.3		
SMP03-160x18-B40-MP12-12	○	160	40	80	60	18	45	12	B	2.4	MPHT1204	
SMP03-200x16-C40-MP12-14	○	200	40	92	50	16	52	14	C	3.6		
SMP03-200x18-C40-MP12-14	○	200	40	92	50	18	52	14	C	3.9		
SMP03-200x20-C40-MP12-14	○	200	40	92	50	20	52	14	C	4.2		

● Ex stock ○ On demand

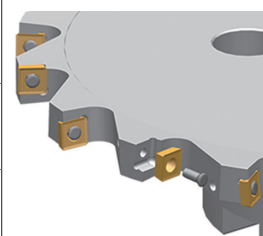
* With internal cooling

Spare parts

	Insert ØD	MPHT0603 80-125	MPHT0803 125-200	MPHT1204 125-200	
	Screw (insert)	I60M2.5x6.5 (1.0 Nm)	I60M3x7 (1.8 Nm)	I60M5x13 (6.7 Nm)	
	Wrench (insert)	WT07IP	WT09IP		
	Wrench (insert)			WT20IS	

System code > B26

Grade selection > B24

Technical info > B527

Cutting data > B230



A

Turning

B

Milling

C

Drilling

D

Technical Information

E

Index

A

Turning

B

Milling

C

Drilling

D

Technical Information

E

Index

- Ideal machining conditions
- Normal machining conditions
- Unfavourable machining conditions

MPHT	L	I.C	S	d
06 03	6.35	6.35	3.18	2.8
08 03	8.3	8.3	3.18	3.4
12 04	12.7	12.7	4.76	5.56

Milling inserts

MP** milling insert		HC ¹ (CVD)						HC ¹ (PVD)					HT	HC ²	HW									
	P	●	●	●	●	●	●	●	●	●	●	●	●	●										
	M	●	●	●	●	●	●	●	●	●	●	●	●	●										
	K							●							●									
	N							●							●	●								
	S			●	●			●	●	●	●	●	●											
	H																							
ISO		r	YBC302	YBC301	YBC401	YBM253	YBM251	YBM351	YBD152	YBD252	YBG101	YBG102	YBG202	YBG212	YBS203	YBG205	YB9320	YBG302	YBS303	YBG252	YNG151	YNG151C	YD101	YD201
	MPHT060304-DM	0.4	●			●											●							
	MPHT080305-DM	0.5	●			○												●						
	MPHT120408-DM	0.8	●			○		●										●						

● Ex stock ○ On demand

HC¹ Coated carbide
 HT Uncoated cermet
 HC² Coated cermet
 HW Uncoated carbide



SM P 03 – 160 × 16 – K 40 – M P 12 – 12 L

1 2 3 4 5 6 7 8 9 10 11 12

A

Turning

Type	
Code	Description
SM	Slot milling cutter

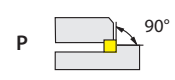
Entering angle

1

2

B

Milling

Serial number

Nominal diameter [mm]

Cutting width [mm]

3

4

5

C

Drilling

Tool holder type			
Code	Description	Code	Description
A	A type	B	B type
C	C type	D	D type
K	With feather key		



Diameter of mounting hole [mm]

6

7

D

Technical Information

Insert shape	
M 	S 

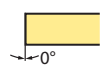
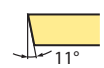
Clearance angle	
N 	P 

Insert size [mm]

8

9

10

Number of teeth

Cutting direction	
Code	Description
R	Right
L	Left

11

12

E

Index

S P K N 12 04 ED T21K R – DM

1

2

3

4

5

6

7

8

9

10

A

Turning

B

Milling

C

Drilling

D

Technical Information

E

Index

Insert shape	
A	C
H	L
M	O
P	R
S	T
W	X Special
Z Special	

Clearance angle	
B	C
D	E
F	N
P	

Tolerance class			
Code	I.C [mm]	m [mm]	S [mm]
A	±0,025	±0,005	±0,025
C	±0,025	±0,013	±0,025
E	±0,025	±0,025	±0,025
F	±0,013	±0,005	±0,025
G	±0,025	±0,025	±0,130
H	±0,013	±0,013	±0,025
J	±0,05-0,13	±0,005	±0,025
K	±0,05-0,13	±0,013	±0,025
L	±0,05-0,13	±0,025	±0,025
M	±0,05-0,13	±0,08-0,18	±0,130
N	±0,05-0,13	±0,08-0,18	±0,025
U	±0,08-0,25	±0,13-0,38	±0,130

1

2

3

Fastening features (metric)	
Insert shape	
A	B
C	F
G	H
J	M
N	Q
R	T
U	W
X Special	

Cutting edge length l [mm]	
Insert shape	
A	C, M
H, O, P	L
R	S
T	W

4

5

Insert thickness S [mm]			
Code	S	Code	S
00	0,79	05	5,56
T0	0,99	T5	5,95
01	1,59	06	6,35
T1	1,98	T6	6,75
02	2,38	07	7,94
T2	2,58	09	9,52
03	3,18	T9	9,72
T3	3,97	11	11,11
04	4,76	12	12,70
T4	4,96		

6

Angle			
Code	Kr	Code	an
A	45°	A	3°
D	60°	B	5°
E	75°	C	7°
F	85°	D	15°
P	90°	E	20°
Z	Special	F	25°
		G	30°
		N	0°
		P	11°
		Z	Special

7

Chamfer							
Code	Type	Code	Angle	Code	Width [mm]	Code	Position
F		0	5°	0	0,10	K	
E		1	10°	1	0,15	P	
T		2	15°	2	0,20	W	
S		3	20°	3	0,25	-	
		4	25°	4	0,30		
		5	30°	5	0,35		
				6	0,40		
				7	0,45		

8

Cutting direction	
Code	Description
R	Right
L	Left
N	Right and left

9

Chip breaker overview
(on page B20)

10

A

Turning

B

Milling

C

Drilling

D

Technical Information

E

Index

Guide for recommended cutting data – indexable milling

Indexable milling – group 1 (FMA07/11/12, FMD02, EMP09/13)

Material group	Composition / structure / heat treatment	Brinell hardness HB	Machining group	Starting values for cutting speed v_c (m/min)								
				HC (CVD)								
				YBC302		YBC401		YBD152		YBD252		
				a_p / D		a_p / D		a_p / D		a_p / D		
1/1 3/4		1/5		1/1 3/4		1/5		1/1 3/4		1/5		
P Unalloyed steel	ca. 0,15 % C	annealed	125	1	260	300	225	260				
	ca. 0,45 % C	annealed	190	2	225	255	195	225				
	ca. 0,45 % C	tempered	250	3	210	240	180	210				
	ca. 0,75 % C	annealed	270	4	185	210	160	185				
	ca. 0,75 % C	tempered	300	5	170	195	150	170				
P Low-alloyed steel		annealed	180	6	225	255	195	225				
		tempered	275	7	185	210	160	185				
		tempered	300	8	170	195	150	170				
		tempered	350	9	145	165	125	145				
P High-alloyed steel and high-alloyed tool steel		annealed	200	10	130	150	115	130				
		hardened and tempered	325	11	95	105	80	95				
M Stainless steel	ferritic/martensitic	annealed	200	12								
	martensitic	tempered	240	13								
	austenitic	quench hardened	180	14								
	austenitic-ferritic		230	15								
K Grey cast iron	perlitic/ferritic		180	16				370	430	320	370	
	perlitic (martensitic)		260	17				220	255	190	220	
K Cast iron with spheroidal graphite	ferritic		160	18				255	295	220	255	
	perlitic		250	19				170	200	145	170	
K Malleable cast iron	ferritic		130	20				305	355	265	305	
	perlitic		230	21				205	240	175	205	
N Aluminium wrought alloys	cannot be hardened		60	22								
	hardenable	hardened	100	23								
	$\leq 12\% \text{ Si}$, cannot be hardened		75	24								
	$\leq 12\% \text{ Si}$, hardenable	hardened	90	25								
N Cast aluminium alloys	$> 12\% \text{ Si}$, cannot be hardened		130	26								
	machining steel, PB > 1%		110	27								
	CuZn, CuSnZn		90	28								
S Copper and copper alloys (bronze/brass)	CuSn, Pb-free copper, electrolytic copper		100	29								
	Heat-resistant alloys	Fe-based alloys	annealed	200	30							
		hardened	280	31								
	Ni or Co base	annealed	250	32								
hardened		350	33									
Titanium alloys	cast	320	34									
	pure titanium		R_m 400	35								
H Hardened steel	α and β alloys	hardened	R_m 1050	36								
	hardened and tempered		55 HRC	37								
H Hard cast iron	hardened and tempered		60 HRC	38								
	cast		400	39								
H Hardened cast iron	hardened and tempered		55 HRC	40								
	Thermoplasts			41								
X Non-metallic materials	Thermosetting plastics			42								
	Plastic, glass-fibre reinforced GFRP			43								
	Plastic, carbon fibre reinforced CFRP			44								
	Graphite			45								
	Wood			46								

Note: The given cutting values are guide values, which were determined under ideal conditions.

The values have to be adapted in individual cases.

Feed rate recommendations on page B248

For examples of material for cutting tool groups view page D22.

Recommend feed rate

Indexable milling – group1 (FMA07/11/12, FMD02, EMP09/13)

5	Material group	Feed rate per cutting edge [mm]																			
		EMP09			EMP13			EMP13			FMA07			FMA07			FMA11				
		LNKT12			ANGX11			ANGX15			ONHU06			ONHU08			SNEG12				
		Application																			
		F	M	R	F	M	R	F	M	R	F	M	R	F	M	R	F	M	R		
P	Unalloyed steel		0,25	0,50		0,23			0,25		0,19	0,23		0,19	0,23		0,20	0,23			
	Low-alloyed steel		0,23	0,47		0,22			0,23		0,17	0,22		0,17	0,22		0,19	0,21			
	High-alloyed steel and high-alloyed tool steel		0,22	0,44		0,20			0,22		0,16	0,20		0,16	0,20		0,18	0,20			
M	Stainless steel		0,18	0,35													0,14	0,16			
K	Grey cast iron		0,28	0,55		0,26			0,28		0,20	0,26		0,20	0,26		0,22	0,25			
	Cast iron with spheroidal graphite		0,25	0,50		0,23			0,25		0,19	0,23		0,19	0,23		0,20	0,23			
	Malleable cast iron		0,25	0,50		0,23			0,25		0,19	0,23		0,19	0,23		0,20	0,23			
N	Aluminium wrought alloys					0,20			0,21												
	Aluminium-Gusslegierungen					0,20			0,21												
	Copper and copper alloys(bronze/brass)					0,18			0,19												
S	Heat-resistant alloys																				
	Titanium alloys																				
H	Hardened steel																				
	Hard cast iron																				
	Hardened cast iron																				
X	Non-metallic materials																				

1. Select the appropriate product family/cutting data group.
2. Select the used grade.
3. Determine the immersion.
4. Select the used material and read the cutting speed.
5. Please have a look at the detached feed rate recommendations.
6. Select the used tool, the machining mode and the used material.

A

Turning

B

Milling

C

Drilling

D

Technical Information

E

Index

Indexable milling – group 5 (SMP01/03/05)

	Material group	Composition / structure / heat treatment		Brinell hardness HB	Machining group	Starting values for cutting speed v_c [m/min]			
						HC (CVD)		HC (PVD)	
						YBC302	YBM253	YBG101	YB9320
		a_e / D	a_e / D	a_e / D	a_e / D				
		1/4	1/4	1/4	1/4				
P	Unalloyed steel	approx. 0,15 % C	annealed	125	1	165	180	190	175
		approx. 0,45 % C	annealed	190	2	145	155	165	150
		approx. 0,45 % C	tempered	250	3	135	145	155	140
		approx. 0,75 % C	annealed	270	4	120	130	135	125
		approx. 0,75 % C	tempered	300	5	110	120	125	115
P	Low-alloyed steel		annealed	180	6	145	155	165	150
			tempered	275	7	120	130	135	125
			tempered	300	8	110	120	125	115
			tempered	350	9	95	100	105	100
P	High-alloyed steel and high-alloyed tool steel		annealed	200	10	85	90	95	90
			hardened and tempered	325	11	60	65	70	65
M	Stainless steel	ferritic/martensitic	annealed	200	12		90	95	90
		martensitic	tempered	240	13		80	80	75
		austenitic	quench hardened	180	14		100	105	95
		austenitic-ferritic		230	15		80	80	75
K	Grey cast iron	perlitic/ferritic		180	16			215	190
		perlitic (martensitic)		260	17			125	115
	Cast iron with spheroidal graphite	ferritic		160	18			145	135
		perlitic		250	19			95	90
K	Malleable cast iron	ferritic		130	20			175	160
		perlitic		230	21			115	105
N	Aluminium wrought alloys	cannot be hardened		60	22				
		hardenable	hardened	100	23				
	Cast aluminium alloys	$\leq 12\% \text{ Si}$, cannot be hardened		75	24				
		$\leq 12\% \text{ Si}$, hardenable	hardened	90	25				
		$> 12\% \text{ Si}$, cannot be hardened		130	26				
	Copper and copper alloys (bronze/brass)	machining steel, PB > 1%		110	27				
CuZn, CuSnZn		90	28						
S	Heat-resistant alloys	Fe-based alloys	annealed	200	30				
			hardened	280	31				
		Ni or Co base	annealed	250	32				
			hardened	350	33				
		cast	320	34					
Titanium alloys	pure titanium		R_m 400	35					
	α and β alloys	hardened	R_m 1050	36					
H	Hardened steel		hardened and tempered	55 HRC	37				
			hardened and tempered	60 HRC	38				
	Hard cast iron		cast	400	39				
	Hardened cast iron		hardened and tempered	55 HRC	40				
X	Non-metallic materials	Thermoplasts			41				
		Thermosetting plastics			42				
		Plastic, glass-fibre reinforced GFRP			43				
		Plastic, carbon fibre reinforced CFRP			44				
		Graphite			45				
		Wood			46				

Note: The given cutting values are guide values, which were determined under ideal conditions.
 The values have to be adapted in individual cases.
 Feed rate recommendations on page B254.
 For examples of material for cutting tool groups view page D11.

Starting values for cutting speed v_c [m/min]		
HC (PVD)		
YBG205	YBG302	
a_e / D	a_e / D	
1/4	1/4	
170	160	
145	140	
140	130	
120	115	
115	105	
145	140	
120	115	
115	105	
95	90	
85	80	
60	60	
85	80	
75	70	
95	85	
75	70	
185	175	
115	105	
130	120	
85	80	
155	145	
105	100	

HC Coated carbide
 HT Uncoated carbide, main component (TiC) o. (TiN), cermet
 HC₁ Coated cermet
 HW Uncoated carbide, main component (WC)

Recommended feed rate

Indexable milling – group 5 (SMP01/03/05)

Material group	Feed rate per cutting edge [mm]									
	SMP01	SMP01	SMP01	SMP01	SMP01	SMP03	SMP03	SMP03	SMP05	
	XSEQ1202	XSEQ1203	XSEQ12T3	XSEQ1204	XSEQ12T4	MPHT06	MPHT08	MPHT12	QC16	
	Tool diameter [mm]									
	63-100	63-100	63-160	63-160	63-160	80-125	125-200	120-200	25-39	
P Unalloyed steel	0,12	0,12	0,13	0,13	0,14	0,14	0,15	0,16	0,08	
	0,11	0,11	0,12	0,12	0,13	0,13	0,14	0,15	0,08	
	0,10	0,10	0,11	0,11	0,12	0,12	0,13	0,14	0,07	
M Stainless steel	0,10	0,10	0,11	0,11	0,12	0,12	0,13	0,14	0,07	
K Grey cast iron	0,11	0,11	0,12	0,12	0,13	0,13	0,14	0,15	0,08	
	0,11	0,11	0,12	0,12	0,13	0,13	0,14	0,15	0,07	
	0,11	0,11	0,12	0,12	0,13	0,13	0,14	0,15	0,07	
N Aluminium wrought alloys										
S Heat-resistant alloys										
H Hardened steel										
X Non-metallic materials										

Note: The given cutting values are guide values, which were determined under ideal conditions.
The values have to be adapted in individual cases.

Indexable milling – group 6 (FMD03, FME04, FMP03, HMP01)

Material group	Feed rate per cutting edge [mm]																	
	FMD03			FMD03			FME04			FMP03			FMP03			FMP03		
	LNKT20			LNKT25			LNKT15			LNKT12			LNKT15			LNKT20		
	Application																	
	F	M	R	F	M	R	F	M	R	F	M	R	F	M	R	F	M	R
P Unalloyed steel			0,50			0,50			0,45			0,45			0,45			0,50
			0,47			0,47			0,42			0,42			0,42			0,47
			0,44			0,44			0,40			0,40			0,40			0,44
M Stainless steel			0,45			0,45			0,40			0,40			0,40			0,45
K Grey cast iron			0,55			0,55			0,50			0,50			0,50			0,55
			0,50			0,50			0,45			0,45			0,45			0,50
			0,50			0,50			0,45			0,45			0,45			0,50
N Aluminium wrought alloys																		
S Heat-resistant alloys																		
H Hardened steel																		
X Non-metallic materials																		

Note: The given cutting values are guide values, which were determined under ideal conditions.
The values have to be adapted in individual cases.

A

Turning

Feed rate per cutting edge [mm]	
SMP05	
QC22	
Tool diameter [mm]	
44	
0,08	
0,08	
0,07	
0,07	
0,08	
0,07	
0,07	

B

Milling

Feed rate per cutting edge [mm]			
FMP03	HMP01		
LNKT25	SPMT-APKT		
Application			
F	M	R	
		0,55	0,25
		0,51	0,23
		0,48	0,22
		0,47	0,15
		0,61	0,28
		0,55	0,25
		0,55	0,25

C

Drilling

D











Technical Information

E

Index

F Finishing
M Medium machining
R Roughing

Slot milling

Series	Milling body	Inserts	Kr	Application						Features	Page
				P	M	K	N	S	H		
SMP01		 XSEQ1202 XSEQ1203 XSEQ12T3 XSEQ1204 XSEQ12T4	90°	✓	✓	✓				<ul style="list-style-type: none"> • Diameter range Ø100 – 250 mm • For steel, stainless steel and cast iron • Bore with keyway • Groove widths 4, 5, 6, 7, 8 mm 	B151
SMP01		 XSEQ1202 XSEQ1203 XSEQ12T3 XSEQ1204 XSEQ12T4	90°	✓	✓	✓				<ul style="list-style-type: none"> • Diameter range Ø63 – 160 mm • For steel, stainless steel and cast iron • Groove widths 4, 5, 6, 7, 8 mm 	B153
SMP03		 MPHT0603 MPHT0803 MPHT1204	90°	✓	✓	✓				<ul style="list-style-type: none"> • Diameter range Ø80 – 200 mm • For steel, stainless steel and cast iron • Bore with keyway • Groove widths 8, 10, 12, 16, 18, 20 mm 	B155
SMP03		 MPHT0603 MPHT0803 MPHT1204	90°	✓	✓	✓				<ul style="list-style-type: none"> • Diameter range Ø80 – 200 mm • For steel, stainless steel and cast iron • Groove widths 8, 10, 12, 16, 18, 20 mm 	B157
SMP05		 QC16L QC22L	90°	✓	✓	✓				<ul style="list-style-type: none"> • Diameter range Ø25 – 44 mm • For steel, stainless steel and cast iron • Groove widths range 1,1 – 4,8 mm 	B159

✓ Very suitable ✓ Suitable

A

Turning

B

Milling

C

Drilling

D

Technical Information

E

Index

Coated cemented carbide CVD

Grade	ISO	Micro structure	Grade description
YBC302	P20 - P35		CVD coated P20-P35 carbide grade for medium operation to roughing of steel at higher cutting speed. Optimal performance of wear resistance and toughness for a wide application field.
YBC301	P20 - P35		CVD coated P20-P35 carbide grade for medium operation to roughing of steel at lower cutting speed.
YBC401	P30 - P50 M30 - M40		CVD coated P30-P50/M30-M40 carbide grade for roughing operation of steel at lower cutting speed and unstable condition.
YBM251	P20 - P30 M15 - M35		CVD coated P20-P30/M15-M35 carbide grade for medium to roughing operation in stainless steel and steel with wide application field. Good wear resistance and capability against plastic deformation at normal cutting speed.
YBM253	M15 - M35		CVD coated M15-M35 carbide grade for medium to roughing operation in stainless steel with wide application field. High wear resistance and capability against plastic deformation at higher cutting speed.
YBM351	P25 - P40 M20 - M40		CVD coated P25-P40/M25-M40 carbide grade for roughing operation in stainless steel and steel. Good wear resistance and edge stability at normal cutting speed.
YBD152	K10 - K25		CVD coated K10-K25 carbide substrate. Optimized for medium to roughing operation of cast iron. Good wear resistance and toughness at higher cutting speed.
YBD252	K20 - K35		CVD coated K20-K35 carbide substrate. Optimized for medium to roughing operation of cast iron and Steel. Good wear resistance and toughness at higher cutting speed.

A

Turning

B

Milling

C

Drilling

DTechnical
Information**E**

Index

Coated cemented carbide PVD

Grade	ISO	Micro structure	Grade description
A Turning	YBG101	N05–N20	 <p>PVD coated N05–N20 carbide substrate for finishing to semi-finishing in aluminium materials. Coating only on the top face, in combination with the aluminium chip breakers, prevents built-up edges and gives a smooth cut.</p>
B Milling	YBG202	P10 - P30 M10-M25	 <p>PVD coated P10–P30/M10–M25 carbide substrate for finishing to medium application of stainless steel and steel (milling). Good wear resistance in a wide application field.</p>
D Technical Information	YBS203	S15 – S25	 <p>Turning and milling grades for processing heat-resistant materials. A special carbon substrate and the latest PVD coating technology enable a very good wear behaviour, high fracture toughness and high thermal stability.</p>
YBG302	P15 - P30 M25 - M40	 <p>PVD multilayer coated P10–P30/M10–M25 carbide substrate for finishing to medium machining of stainless steel, super alloys and steel (grooving/milling). Optimised coating stability for higher wear resistance and thermal stability in a wide range of applications.</p>	
			YBG302

Coated cemented carbide PVD

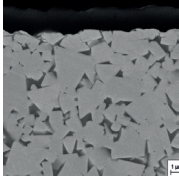
Grade	ISO	Micro structure	Grade description
YBS303	S25 - S35		Milling grade for machining titanium alloys. A tough carbide substrate and the latest PVD coating technology with increased impact resistance and high thermal stability.

Cermet

Grade	ISO	Micro structure	Grade description
YNG151	P05 - P15		Uncoated P05-P15 cermet grade for fine finishing operation of steel and stainless steel. Good resistance against plastic deformation for good surface finishing.
YNG151C	P05 - P15		PVD coated P05-P15 cermet grade for fine finishing operation of steel and stainless steel. Good wear resistance and capability against plastic deformation for good surface roughness.

Uncoated cemented carbide

Grade	ISO	Micro structure	Grade description
YD101	N05 - N25 K05 - K20		Uncoated K05-K20/N05-N20 carbide substrate for fine to medium application in aluminum and other material.
YD201	K10 - K30 N10 - N30		Uncoated K10-K30/N10-N30 carbide substrate for medium application in aluminum and other material.

A

Turning

B

Milling

C

Drilling

DTechnical
Information**E**

Index

Application fields of grades – indexable milling

	ISO	HC ¹ (CVD)	HC ¹ (PVD)	HT	HC ²	HW	PCBN/PCD
P	P01		YBG102		YNG151C		
	P10		YBG202	YNG151			
	P20	YBC301	YBG205				
	P30	YBC401	YBG302			YC305	
	P40	YBM351	YB9320				
M	M01		YBG102		YNG151C		
	M10	YBM251	YBG202	YNG151			
	M20	YBM253	YBG205				
	M30	YBM351	YBG302			YC305	
	M40	YBC401	YB9320				
K	K01		YBG102				
	K10	YBD152	YBG152				
	K20	YBD252	YBG202			YD201	
	K30						
	K40						
N	N01					YD051	
	N10		YBG101			YD101	
	N20		YBG202				YD201
	N30						
S	S01		YBG102				
	S10		YBG202				
	S20		YBG205				
	S30		YBS203				
			YBS303				
H	H01		YBG102				
	H10						
	H20						
	H30						

P	Steel
M	Stainless steel
K	Cast iron

N	Non-ferrous metals
S	Heat-resistant alloys
H	Hardened materials

HC ¹	Coated carbide
HT	Uncoated cermet
HC ²	Coated carbide
HW	Uncoated carbide