

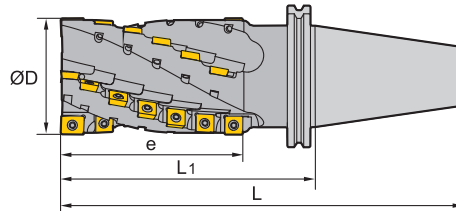

Helical milling

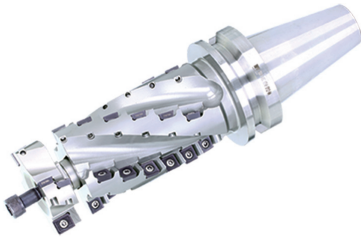



HMP01 EC Kr: 90° 



Article	*	Stock	Dimensions [mm]				Teeth row	Teeth		Shanktype	Inserts 
			ØD	e	L <sub>1</sub>	L		APKT	SPMT		
HMP01-050x84EC-BT50-SP12-04		○	50	84	145	246.8	4	2	16	BT	APKT1504 & SPMT1204
HMP01-050x84EC-JT50-SP12-04		●	50	84	145	246.75	4	2	16	JT	
HMP01-063x74EC-BT50-SP12-04		○	63	74	135	236.8	4	2	14	BT	
HMP01-063x74EC-JT50-SP12-04		○	63	74	135	236.75	4	2	14	JT	
HMP01-063x104EC-BT50-SP12-04		○	63	104	165	266.8	4	2	20	BT	
HMP01-063x104EC-JT50-SP12-04		○	63	104	165	266.75	4	2	20	JT	
HMP01-063x134EC-BT50-SP12-04		○	63	134	195	296.8	4	2	26	BT	
HMP01-063x134EC-JT50-SP12-04		●	63	134	195	296.75	4	2	26	JT	
HMP01-080x104EC-BT50-SP12-04		○	80	104	165	266.8	4	2	20	BT	
HMP01-080x104EC-JT50-SP12-04		○	80	104	165	266.75	4	2	20	JT	
HMP01-080x144EC-BT50-SP12-04		○	80	144	205	306.8	4	2	28	BT	
HMP01-080x144EC-JT50-SP12-04		○	80	144	205	306.75	4	2	28	JT	

● Ex stock ○ On demand

\* With internal cooling

Spare parts		APKT1504 & SPMT1204	APKT1504 & SPMT1204	APKT1504 & SPMT1204
Insert	ØD	50	63	80
 Indexable head		050EC	063EC	080EC
 Screw (head)		M10×50 (16.6 Nm)	M10×50 (16.6 Nm)	M12×55 (25.2 Nm)
 Screw (insert)		I60M5×13 (6.7 Nm)	I60M5×13 (6.7 Nm)	I60M5×13 (6.7 Nm)
 Wrench (head)		WH80L	WH80L	WH100L
 Wrench (insert)		WT20IS	WT20IS	WT20IS

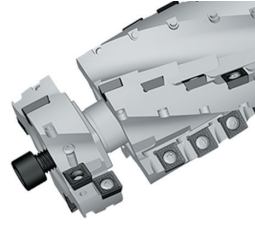

System code > B26

Grade selection > B24

Technical info > B527

Cutting data > B230

A

Turning

B

Milling

C

Drilling

D

Technical Information

E

Index

**A**

Turning

**B**

Milling

**C**

Drilling

**D**

Technical Information

**E**

Index

- Ideal machining conditions
- ⊗ Normal machining conditions
- ⊗ Unfavourable machining conditions

APKT	L	S	d
15 04	16.33	4.76	5.4

## Milling inserts

AP** milling insert		HC <sup>1</sup> (CVD)						HC <sup>1</sup> (PVD)					HT	HC <sup>2</sup>	HW										
	<b>P</b>	<span style="color: blue;">⊗</span>	<span style="color: blue;">⊗</span>	<span style="color: blue;">⊗</span>	<span style="color: blue;">⊗</span>	<span style="color: blue;">⊗</span>	<span style="color: blue;">⊗</span>	<span style="color: blue;">⊗</span>	<span style="color: blue;">⊗</span>	<span style="color: blue;">⊗</span>	<span style="color: blue;">⊗</span>	<span style="color: blue;">⊗</span>	<span style="color: blue;">⊗</span>	<span style="color: blue;">⊗</span>											
	<b>M</b>	<span style="color: yellow;">⊗</span>	<span style="color: yellow;">⊗</span>	<span style="color: yellow;">⊗</span>	<span style="color: yellow;">⊗</span>	<span style="color: yellow;">⊗</span>	<span style="color: yellow;">⊗</span>	<span style="color: yellow;">⊗</span>	<span style="color: yellow;">⊗</span>	<span style="color: yellow;">⊗</span>	<span style="color: yellow;">⊗</span>	<span style="color: yellow;">⊗</span>	<span style="color: yellow;">⊗</span>	<span style="color: yellow;">⊗</span>											
	<b>K</b>								<span style="color: red;">●</span>							<span style="color: red;">●</span>									
	<b>N</b>									<span style="color: green;">⊗</span>						<span style="color: green;">⊗</span>									
	<b>S</b>		<span style="color: orange;">⊗</span>	<span style="color: orange;">⊗</span>						<span style="color: orange;">⊗</span>	<span style="color: orange;">⊗</span>	<span style="color: orange;">⊗</span>	<span style="color: orange;">⊗</span>	<span style="color: orange;">⊗</span>											
	<b>H</b>																								
ISO	r	I.W	YBC302	YBC301	YBC401	YBM253	YBM251	YBM351	YBD152	YBD252	YBG101	YBG102	YBG202	YBG212	YBS203	YBG205	YB9320	YBG302	YBS303	YBG252	YNG151	YNG151C	YD101	YD201	
	APKT150412-PM	1.2	12.7				●											●							

● Ex stock   ○ On demand

HC<sup>1</sup> Coated carbide  
 HT Uncoated cermet  
 HC<sup>2</sup> Coated cermet  
 HW Uncoated carbide

- Ideal machining conditions
- ⊗ Normal machining conditions
- ⊗ Unfavourable machining conditions

SPMT	L	I.C	S	d
12 04	12.7	12.7	4.76	5.5

## Milling inserts

SP** milling insert		HC <sup>1</sup> (CVD)						HC <sup>1</sup> (PVD)					HT	HC <sup>2</sup>	HW									
	<b>P</b>	<span style="color: blue;">⊗</span>	<span style="color: blue;">⊗</span>	<span style="color: blue;">⊗</span>	<span style="color: blue;">⊗</span>	<span style="color: blue;">⊗</span>	<span style="color: blue;">⊗</span>	<span style="color: blue;">⊗</span>	<span style="color: blue;">⊗</span>	<span style="color: blue;">⊗</span>	<span style="color: blue;">⊗</span>	<span style="color: blue;">⊗</span>	<span style="color: blue;">⊗</span>	<span style="color: blue;">⊗</span>										
	<b>M</b>	<span style="color: yellow;">⊗</span>	<span style="color: yellow;">⊗</span>	<span style="color: yellow;">⊗</span>	<span style="color: yellow;">⊗</span>	<span style="color: yellow;">⊗</span>	<span style="color: yellow;">⊗</span>	<span style="color: yellow;">⊗</span>	<span style="color: yellow;">⊗</span>	<span style="color: yellow;">⊗</span>	<span style="color: yellow;">⊗</span>	<span style="color: yellow;">⊗</span>	<span style="color: yellow;">⊗</span>	<span style="color: yellow;">⊗</span>										
	<b>K</b>									<span style="color: red;">●</span>						<span style="color: red;">●</span>								
	<b>N</b>										<span style="color: green;">⊗</span>					<span style="color: green;">⊗</span>								
	<b>S</b>		<span style="color: orange;">⊗</span>	<span style="color: orange;">⊗</span>						<span style="color: orange;">⊗</span>	<span style="color: orange;">⊗</span>	<span style="color: orange;">⊗</span>	<span style="color: orange;">⊗</span>	<span style="color: orange;">⊗</span>										
	<b>H</b>																							
ISO	r	YBC302	YBC301	YBC401	YBM253	YBM251	YBM351	YBD152	YBD252	YBG101	YBG102	YBG202	YBG212	YBS203	YBG205	YB9320	YBG302	YBS303	YBG252	YNG151	YNG151C	YD101	YD201	
	SPMT120408-PM	0.8					●										●							

● Ex stock   ○ On demand

HC<sup>1</sup> Coated carbide  
 HT Uncoated cermet  
 HC<sup>2</sup> Coated cermet  
 HW Uncoated carbide

System code > B26

Grade selection > B24

Technical info > B527



Cutting data > B230

## FM A 12 050 – A22 O – N 06 – 04 (L) (C)

1 2 3 4 5 6 7 8 9 10 11

Type	
Code	Description
BM	Profile milling
CM	Chamfer milling
EM	Square shoulder milling
FM	Face milling
HM	Helical milling
SM	Slot milling
TM	T-slot milling
XM	Special

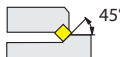
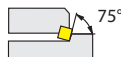
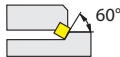
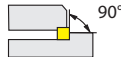
1

Entering angle			
A		E	
D		P	
R			

2

Serial number
---------------

3





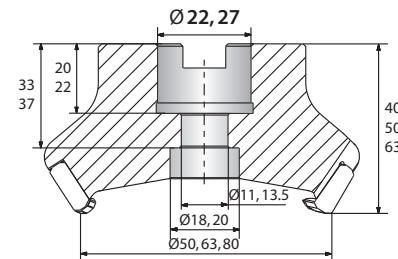
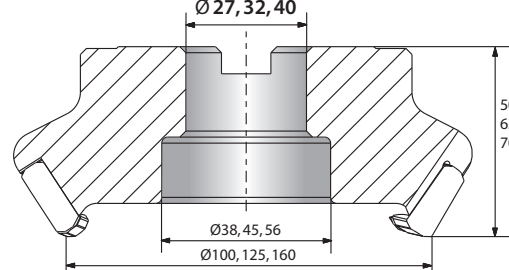
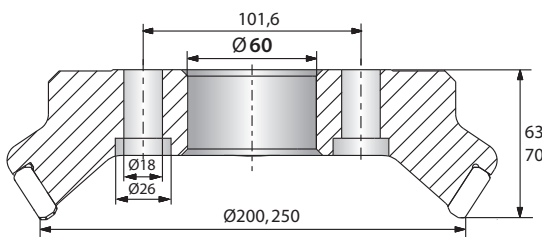
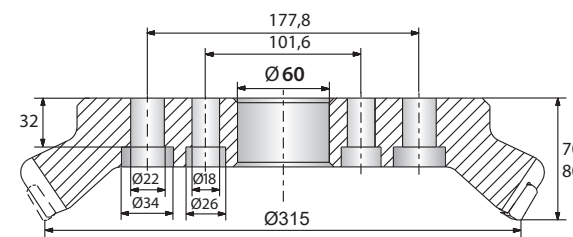





Nominal diameter [mm]	
Code	Description
025	25
050	50
160	160
315	315
...	

4







Type and size of tool holders			
Code	Type	Code	Type
A	<p>Nominal diameter <math>\varnothing 50 - 80</math> mm</p> 	B	<p>Nominal diameter <math>\varnothing 100 - 160</math> mm</p> 
C	<p>Nominal diameter <math>\varnothing 200 - 250</math> mm</p> 	D	<p>Nominal diameter <math>\varnothing 315</math> mm</p> 
G	Straight shank	XP	Weldon shank
K	Bore with keyway		

5









With respect to mounting please adhere to the information provided by the tool holder manufacturer.

Insert shape	
A 	C 
H 	L 
M 	O 
P 	R 
S 	T 
W 	X Special
Z Special	

6

Clearance angle	
B 	C 
D 	E 
F 	N 
P 	

7

Cutting edge length l [mm]	
Insert shape	
	
A	C, M
	
H, O, P	L
	
R	S
	
T	W

8

Number of teeth

9

Cutting direction	
Code	Description
L	Left

10

With inner cooling

11



Tools with B coupling and inner coolant supply require the following spare parts:





Coolant clamp screw



Coolant shower plate



Spare parts (B coupling with inner coolant supply)

		B27	B32	B40	B40
	Ø	80	100	125	160
	Coolant clamp screw	LDB27C	LDB32C	LDB40C	LDB40C
	Coolant shower plate	B27-002-CP	B32-002-CP	B40-002-CP	B40-003-CP

When purchasing tools with inner coolant supply and B coupling these spare parts are included in delivery.

A

Turning

B

Milling

C

Drilling

D

Technical Information

E

Index

**S P K N 12 04 ED T21K R – DM**

**1**

**2**

**3**

**4**

**5**

**6**

**7**

**8**

**9**

**10**

**A**

Turning

**B**

Milling

**C**

Drilling

**D**

Technical Information

**E**

Index

Insert shape	
A	C
H	L
M	O
P	R
S	T
W	X Special
Z Special	

Clearance angle	
B	C
D	E
F	N
P	

Tolerance class			
Code	I.C [mm]	m [mm]	S [mm]
A	±0,025	±0,005	±0,025
C	±0,025	±0,013	±0,025
E	±0,025	±0,025	±0,025
F	±0,013	±0,005	±0,025
G	±0,025	±0,025	±0,130
H	±0,013	±0,013	±0,025
J	±0,05-0,13	±0,005	±0,025
K	±0,05-0,13	±0,013	±0,025
L	±0,05-0,13	±0,025	±0,025
M	±0,05-0,13	±0,08-0,18	±0,130
N	±0,05-0,13	±0,08-0,18	±0,025
U	±0,08-0,25	±0,13-0,38	±0,130

**1**

**2**

**3**

Fastening features (metric)	
Insert shape	
A	B
C	F
G	H
J	M
N	Q
R	T
U	W
X Special	

Cutting edge length l [mm]	
Insert shape	
A	C, M
H, O, P	L
R	S
T	W

**4**

**5**

Insert thickness S [mm]			
Code	S	Code	S
00	0,79	05	5,56
T0	0,99	T5	5,95
01	1,59	06	6,35
T1	1,98	T6	6,75
02	2,38	07	7,94
T2	2,58	09	9,52
03	3,18	T9	9,72
T3	3,97	11	11,11
04	4,76	12	12,70
T4	4,96		

**6**

Angle			
Code	Kr	Code	an
A	45°	A	3°
D	60°	B	5°
E	75°	C	7°
F	85°	D	15°
P	90°	E	20°
Z	Special	F	25°
		G	30°
		N	0°
		P	11°
		Z	Special

**7**

Chamfer							
Code	Type	Code	Angle	Code	Width [mm]	Code	Position
F		0	5°	0	0,10	K	
E		1	10°	1	0,15	P	
T		2	15°	2	0,20	W	
S		3	20°	3	0,25	-	
		4	25°	4	0,30		
		5	30°	5	0,35		
				6	0,40		
				7	0,45		

**8**

Cutting direction	
Code	Description
R	Right
L	Left
N	Right and left

**9**

Chip breaker overview  
(on page B20)

**10**

**A**

Turning

**B**

Milling

**C**

Drilling

**D**

Technical Information

**E**

Index

## Guide for recommended cutting data – indexable milling

### Indexable milling – group 1 (FMA07/11/12, FMD02, EMP09/13)

Material group	Composition / structure / heat treatment	Brinell hardness HB	Machining group	Starting values for cutting speed $v_c$ (m/min)								
				HC (CVD)								
				YBC302		YBC401		YBD152		YBD252		
				$a_p / D$		$a_p / D$		$a_p / D$		$a_p / D$		
1/1   3/4		1/5		1/1   3/4		1/5		1/1   3/4		1/5		
P Unalloyed steel	ca. 0,15 % C	annealed	125	1	260	300	225	260				
	ca. 0,45 % C	annealed	190	2	225	255	195	225				
	ca. 0,45 % C	tempered	250	3	210	240	180	210				
	ca. 0,75 % C	annealed	270	4	185	210	160	185				
	ca. 0,75 % C	tempered	300	5	170	195	150	170				
P Low-alloyed steel		annealed	180	6	225	255	195	225				
		tempered	275	7	185	210	160	185				
		tempered	300	8	170	195	150	170				
		tempered	350	9	145	165	125	145				
P High-alloyed steel and high-alloyed tool steel		annealed	200	10	130	150	115	130				
		hardened and tempered	325	11	95	105	80	95				
M Stainless steel	ferritic/martensitic	annealed	200	12								
	martensitic	tempered	240	13								
	austenitic	quench hardened	180	14								
	austenitic-ferritic		230	15								
K Grey cast iron	perlite/ferritic		180	16				370	430	320	370	
	perlite (martensitic)		260	17				220	255	190	220	
K Cast iron with spheroidal graphite	ferritic		160	18				255	295	220	255	
	perlite		250	19				170	200	145	170	
K Malleable cast iron	ferritic		130	20				305	355	265	305	
	perlite		230	21				205	240	175	205	
N Aluminium wrought alloys	cannot be hardened		60	22								
	hardenable	hardened	100	23								
	$\leq 12\% \text{ Si}$ , cannot be hardened		75	24								
	$\leq 12\% \text{ Si}$ , hardenable	hardened	90	25								
N Cast aluminium alloys	$> 12\% \text{ Si}$ , cannot be hardened		130	26								
	machining steel, PB > 1%		110	27								
	CuZn, CuSnZn		90	28								
S Copper and copper alloys (bronze/brass)	CuSn, Pb-free copper, electrolytic copper		100	29								
	Heat-resistant alloys	Fe-based alloys	annealed	200	30							
		hardened	280	31								
	Ni or Co base	annealed	250	32								
hardened		350	33									
Titanium alloys	cast	320	34									
	pure titanium		$R_m 400$	35								
H Hardened steel	$\alpha$ and $\beta$ alloys	hardened	$R_m 1050$	36								
	hardened and tempered		55 HRC	37								
H Hard cast iron	hardened and tempered		60 HRC	38								
	cast		400	39								
H Hardened cast iron	hardened and tempered		55 HRC	40								
	Thermoplasts			41								
X Non-metallic materials	Thermosetting plastics			42								
	Plastic, glass-fibre reinforced GFRP			43								
	Plastic, carbon fibre reinforced CFRP			44								
	Graphite			45								
	Wood			46								

Note: The given cutting values are guide values, which were determined under ideal conditions.

The values have to be adapted in individual cases.

Feed rate recommendations on page B248

For examples of material for cutting tool groups view page D22.

**Recommend feed rate**

**Indexable milling – group1 (FMA07/11/12, FMD02, EMP09/13)**

5	Material group	Feed rate per cutting edge [mm]																			
		EMP09			EMP13			EMP13			FMA07			FMA07			FMA11				
		LNKT12			ANGX11			ANGX15			ONHU06			ONHU08			SNEG12				
		Application																			
		F	M	R	F	M	R	F	M	R	F	M	R	F	M	R	F	M	R		
<b>P</b>	Unalloyed steel		0,25	0,50		0,23			0,25		0,19	0,23		0,19	0,23		0,20	0,23			
	Low-alloyed steel		0,23	0,47		0,22			0,23		0,17	0,22		0,17	0,22		0,19	0,21			
	High-alloyed steel and high-alloyed tool steel		0,22	0,44		0,20			0,22		0,16	0,20		0,16	0,20		0,18	0,20			
<b>M</b>	Stainless steel		0,18	0,35													0,14	0,16			
<b>K</b>	Grey cast iron		0,28	0,55		0,26			0,28		0,20	0,26		0,20	0,26		0,22	0,25			
	Cast iron with spheroidal graphite		0,25	0,50		0,23			0,25		0,19	0,23		0,19	0,23		0,20	0,23			
	Malleable cast iron		0,25	0,50		0,23			0,25		0,19	0,23		0,19	0,23		0,20	0,23			
<b>N</b>	Aluminium wrought alloys					0,20			0,21												
	Aluminium-Gusslegierungen					0,20			0,21												
	Copper and copper alloys (bronze/brass)					0,18			0,19												
<b>S</b>	Heat-resistant alloys																				
	Titanium alloys																				
<b>H</b>	Hardened steel																				
	Hard cast iron																				
	Hardened cast iron																				
<b>X</b>	Non-metallic materials																				

1. Select the appropriate product family/cutting data group.
2. Select the used grade.
3. Determine the immersion.
4. Select the used material and read the cutting speed.
5. Please have a look at the detached feed rate recommendations.
6. Select the used tool, the machining mode and the used material.

A

Turning

B

Milling

C

Drilling

D

Technical Information

E

Index



## Indexable milling – group 6 (FMD03, FME04, FMP03, HMP01)

	Material group	Composition / structure / heat treatment		Brinell hardness HB	Machining group	Starting values for cutting speed $v_c$ [m/min]							
						HC (CVD)							
						YBC302		YBC401		YBD152		YBD252	
						$a_e / D$		$a_e / D$		$a_e / D$		$a_e / D$	
1/1   3/4		1/5		1/1   3/4		1/5		1/1   3/4		1/5			
<b>P</b>	Unalloyed steel	approx. 0,15 % C	annealed	125	1	200	230	170	200				
		approx. 0,45 % C	annealed	190	2	170	200	145	170				
		approx. 0,45 % C	tempered	250	3	160	185	140	160				
		approx. 0,75 % C	annealed	270	4	140	165	120	140				
		approx. 0,75 % C	tempered	300	5	130	150	115	130				
<b>P</b>	Low-alloyed steel		annealed	180	6	170	200	145	170				
			tempered	275	7	140	165	120	140				
			tempered	300	8	130	150	115	130				
			tempered	350	9	110	130	95	110				
<b>P</b>	High-alloyed steel and high-alloyed tool steel		annealed	200	10	100	115	85	100				
			hardened and tempered	325	11	70	85	60	70				
<b>M</b>	Stainless steel	ferritic/martensitic	annealed	200	12								
			martensitic	tempered	240	13							
			austenitic	quench hardened	180	14							
			austenitic-ferritic		230	15							
<b>K</b>	Grey cast iron	perlitic/ferritic		180	16				255	295	220	255	
		perlitic (martensitic)		260	17				150	175	130	150	
	Cast iron with spheroidal graphite	ferritic		160	18				175	205	150	175	
		perlitic		250	19				115	135	100	115	
<b>K</b>	Malleable cast iron	ferritic		130	20				210	245	180	210	
		perlitic		230	21				140	165	120	140	
<b>N</b>	Aluminium wrought alloys	cannot be hardened		60	22								
		hardenable	hardened	100	23								
	Cast aluminium alloys	$\leq 12\% \text{ Si}$ , cannot be hardened		75	24								
		$\leq 12\% \text{ Si}$ , hardenable	hardened	90	25								
		$> 12\% \text{ Si}$ , cannot be hardened		130	26								
	Copper and copper alloys (bronze/brass)	machining steel, PB > 1%		110	27								
CuZn, CuSnZn		90	28										
<b>S</b>	Heat-resistant alloys	Fe-based alloys	annealed	200	30								
			hardened	280	31								
		Ni or Co base	annealed	250	32								
			hardened	350	33								
		cast	320	34									
Titanium alloys	pure titanium		$R_m$ 400	35									
	$\alpha$ and $\beta$ alloys	hardened		$R_m$ 1050	36								
<b>H</b>	Hardened steel		hardened and tempered	55 HRC	37								
			hardened and tempered	60 HRC	38								
	Hard cast iron		cast	400	39								
	Hardened cast iron		hardened and tempered	55 HRC	40								
<b>X</b>	Non-metallic materials	Thermoplasts			41								
		Thermosetting plastics			42								
		Plastic, glass-fibre reinforced GFRP			43								
		Plastic, carbon fibre reinforced CFRP			44								
		Graphite			45								
		Wood			46								

Note: The given cutting values are guide values, which were determined under ideal conditions.  
 The values have to be adapted in individual cases.  
 Feed rate recommendations on page B254.  
 For examples of material for cutting tool groups view page D11.

Starting values for cutting speed $v_c$ [m/min]																
HC (CVD)		HC (PVD)														
YBM253		YBG102		YBG152		YB9320		YBG205		YBG212		YBG252		YBG302		
$a_e / D$		$a_e / D$		$a_e / D$		$a_e / D$		$a_e / D$		$a_e / D$		$a_e / D$		$a_e / D$		
1/1 3/4	1/5	1/1 3/4	1/5	1/1 3/4	1/5	1/1 3/4	1/5	1/1 3/4	1/5	1/1 3/4	1/5	1/1 3/4	1/5	1/1 3/4	1/5	
200	230	205	240	195	225	190	220	185	215	185	215	180	210	175	205	
170	200	175	205	170	195	165	190	160	185	160	185	155	180	150	175	
160	185	165	195	160	180	155	180	150	175	150	175	145	170	140	165	
140	165	145	170	140	160	135	155	130	155	130	155	130	150	125	145	
130	150	135	160	130	150	125	145	125	140	125	140	120	140	115	135	
170	200	175	205	170	195	165	190	160	185	160	185	155	180	150	175	
140	165	145	170	140	160	135	155	130	155	130	155	130	150	125	145	
130	150	135	160	130	150	125	145	125	140	125	140	120	140	115	135	
170	200	175	205	170	195	165	190	160	185	160	185	155	180	150	175	
140	165	145	170	140	160	135	155	130	155	130	155	130	150	125	145	
130	150	135	160	130	150	125	145	125	140	125	140	120	140	115	135	
110	130	115	135	110	125	105	125	105	120	105	120	100	120	100	115	
100	115	105	120	100	115	95	110	95	110	95	110	90	105	90	105	
70	85	75	85	70	80	70	80	65	80	65	80	65	75	65	75	
100	115	105	120	100	115	95	110	95	110	95	110	90	105	90	105	
85	100	90	105	85	95	80	95	80	95	80	95	80	90	75	90	
110	125	110	130	105	120	105	120	100	115	100	115	100	115	95	110	
85	100	90	105	85	95	80	95	80	95	80	95	80	90	75	90	
		230	265	215	250	210	245	205	240	205	240	200	230	195	225	
		135	160	130	150	125	145	125	140	125	140	120	140	115	135	
		155	180	150	170	145	165	140	165	140	165	135	160	135	155	
		105	120	100	115	95	110	95	110	95	110	90	105	90	105	
		185	220	180	205	175	200	170	195	170	195	165	190	160	185	
		125	145	120	135	115	135	115	130	115	130	110	130	105	125	

HC Coated carbide  
 HT Uncoated carbide, main component (TiC) o. (TiN), cermet  
 HC<sub>1</sub> Coated cermet  
 HW Uncoated carbide, main component (WC)

**A**  
Turning  
**B**  
Milling  
**C**  
Drilling  
**D**  
Technical Information  
**E**  
Index

## Recommended feed rate

### Indexable milling – group 5 (SMP01/03/05)

Material group	Feed rate per cutting edge [mm]									
	SMP01	SMP01	SMP01	SMP01	SMP01	SMP03	SMP03	SMP03	SMP05	
	XSEQ1202	XSEQ1203	XSEQ12T3	XSEQ1204	XSEQ12T4	MPHT06	MPHT08	MPHT12	QC16	
	Tool diameter [mm]									
	63-100	63-100	63-160	63-160	63-160	80-125	125-200	120-200	25-39	
<b>P</b>	Unalloyed steel	0,12	0,12	0,13	0,13	0,14	0,14	0,15	0,16	0,08
	Low-alloyed steel	0,11	0,11	0,12	0,12	0,13	0,13	0,14	0,15	0,08
	High-alloyed steel and high-alloyed tool steel	0,10	0,10	0,11	0,11	0,12	0,12	0,13	0,14	0,07
<b>M</b>	Stainless steel	0,10	0,10	0,11	0,11	0,12	0,12	0,13	0,14	0,07
<b>K</b>	Grey cast iron	0,11	0,11	0,12	0,12	0,13	0,13	0,14	0,15	0,08
	Cast iron with spheroidal graphite	0,11	0,11	0,12	0,12	0,13	0,13	0,14	0,15	0,07
	Malleable cast iron	0,11	0,11	0,12	0,12	0,13	0,13	0,14	0,15	0,07
<b>N</b>	Aluminium wrought alloys									
	Aluminum cast alloys									
	Copper and copper alloys (bronze/brass)									
<b>S</b>	Heat-resistant alloys									
	Titanium alloys									
<b>H</b>	Hardened steel									
	Hard cast iron									
	Hardened cast iron									
<b>X</b>	Non-metallic materials									

Note: The given cutting values are guide values, which were determined under ideal conditions.  
The values have to be adapted in individual cases.

### Indexable milling – group 6 (FMD03, FME04, FMP03, HMP01)

Material group	Feed rate per cutting edge [mm]																		
	FMD03			FMD03			FME04			FMP03			FMP03			FMP03			
	LNKT20			LNKT25			LNKT15			LNKT12			LNKT15			LNKT20			
	Application																		
	F	M	R	F	M	R	F	M	R	F	M	R	F	M	R	F	M	R	
<b>P</b>	Unalloyed steel			0,50			0,50			0,45			0,45			0,45			0,50
	Low-alloyed steel			0,47			0,47			0,42			0,42			0,42			0,47
	High-alloyed steel and high-alloyed tool steel			0,44			0,44			0,40			0,40			0,40			0,44
<b>M</b>	Stainless steel			0,45			0,45			0,40			0,40			0,40			0,45
<b>K</b>	Grey cast iron			0,55			0,55			0,50			0,50			0,50			0,55
	Cast iron with spheroidal graphite			0,50			0,50			0,45			0,45			0,45			0,50
	Malleable cast iron			0,50			0,50			0,45			0,45			0,45			0,50
<b>N</b>	Aluminium wrought alloys																		
	Aluminum cast alloys																		
	Copper and copper alloys (bronze/brass)																		
<b>S</b>	Heat-resistant alloys																		
	Titanium alloys																		
<b>H</b>	Hardened steel																		
	Hard cast iron																		
	Hardened cast iron																		
<b>X</b>	Non-metallic materials																		

Note: The given cutting values are guide values, which were determined under ideal conditions.  
The values have to be adapted in individual cases.

		Feed rate per cutting edge [mm]	
	SMP05		
	QC22		
		Tool diameter [mm]	
	44		
	0,08		
	0,08		
	0,07		
	0,07		
	0,08		
	0,07		
	0,07		



		Feed rate per cutting edge [mm]	
	FMP03	HMP01	
	LNKT25	SPMT-APKT	
		Application	
	F	M	R
		0,55	0,25
		0,51	0,23
		0,48	0,22
		0,47	0,15
		0,61	0,28
		0,55	0,25
		0,55	0,25

F Finishing  
M Medium machining  
R Roughing





**A**  
Turning  
**B**  
Milling  
**C**  
Drilling  
**D**  
Technical Information  
**E**  
Index

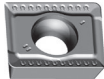

### T-slot milling

Series	Milling body	Inserts	Kr	Application						Features	Page
				P	M	K	N	S	H		
TMP01		 MPHT0603 MPHT0803 MPHT1204	90°	✓	✓	✓				<ul style="list-style-type: none"> <li>• Diameter range Ø21 – 60 mm</li> <li>• For cast iron</li> <li>• Groove widths 9, 11, 14, 18, 22, 28 mm</li> </ul>	B175

### Helical milling

HMP01		 APKT1504 & SPMT1204	90°	✓	✓	✓				<ul style="list-style-type: none"> <li>• Diameter range Ø40 – 50 mm</li> <li>• For steel and cast iron</li> <li>• Weldon shank</li> </ul>	B177
HMP01		 APKT1504 & SPMT1204	90°	✓	✓	✓				<ul style="list-style-type: none"> <li>• Diameter range Ø50 – 80 mm</li> <li>• For steel and cast iron</li> <li>• With JT coupling</li> </ul>	B179
HMP01-EC		 APKT1504 & SPMT1204	90°	✓	✓	✓				<ul style="list-style-type: none"> <li>• Diameter range Ø50 – 80 mm</li> <li>• For steel and cast iron</li> <li>• With JT coupling</li> <li>• With indexable head</li> </ul>	B181

✓ Very suitable    ✓ Suitable

**A**

Turning

**B**

Milling

**C**

Drilling



**D**

Technical Information

**E**

Index

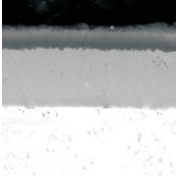
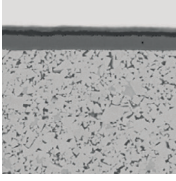
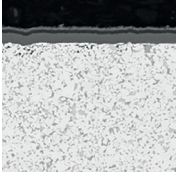
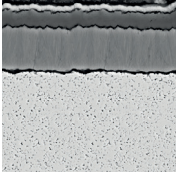
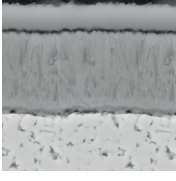
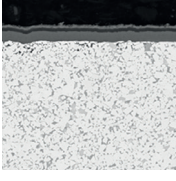
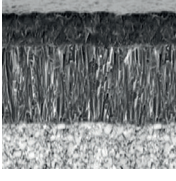
**Coated cemented carbide CVD**

Grade	ISO	Micro structure	Grade description
<b>YBC302</b>	P20 - P35		CVD coated P20-P35 carbide grade for medium operation to roughing of steel at higher cutting speed. Optimal performance of wear resistance and toughness for a wide application field.
<b>YBC301</b>	P20 - P35		CVD coated P20-P35 carbide grade for medium operation to roughing of steel at lower cutting speed.
<b>YBC401</b>	P30 - P50 M30 - M40		CVD coated P30-P50/M30-M40 carbide grade for roughing operation of steel at lower cutting speed and unstable condition.
<b>YBM251</b>	P20 - P30 M15 - M35		CVD coated P20-P30/M15-M35 carbide grade for medium to roughing operation in stainless steel and steel with wide application field. Good wear resistance and capability against plastic deformation at normal cutting speed.
<b>YBM253</b>	M15 - M35		CVD coated M15-M35 carbide grade for medium to roughing operation in stainless steel with wide application field. High wear resistance and capability against plastic deformation at higher cutting speed.
<b>YBM351</b>	P25 - P40 M20 - M40		CVD coated P25-P40/M25-M40 carbide grade for roughing operation in stainless steel and steel. Good wear resistance and edge stability at normal cutting speed.
<b>YBD152</b>	K10 - K25		CVD coated K10-K25 carbide substrate. Optimized for medium to roughing operation of cast iron. Good wear resistance and toughness at higher cutting speed.
<b>YBD252</b>	K20 - K35		CVD coated K20-K35 carbide substrate. Optimized for medium to roughing operation of cast iron and Steel. Good wear resistance and toughness at higher cutting speed.

**A**

Turning

**B**

Milling

**C**

Drilling

**D**Technical  
Information**E**

Index

## Coated cemented carbide PVD

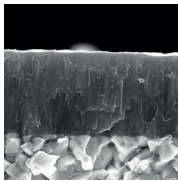
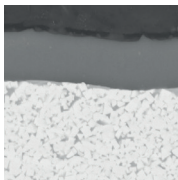
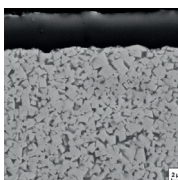
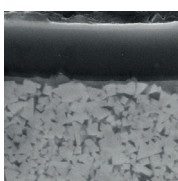
Grade	ISO	Micro structure	Grade description
A Turning	YBG101	N05–N20	 <p>PVD coated N05–N20 carbide substrate for finishing to semi-finishing in aluminium materials. Coating only on the top face, in combination with the aluminium chip breakers, prevents built-up edges and gives a smooth cut.</p>
B Milling	YBG202	P10 - P30 M10-M25	 <p>PVD coated P10–P30/M10–M25 carbide substrate for finishing to medium application of stainless steel and steel (milling). Good wear resistance in a wide application field.</p>
D Technical Information	YBS203	S15 – S25	 <p>Turning and milling grades for processing heat-resistant materials. A special carbon substrate and the latest PVD coating technology enable a very good wear behaviour, high fracture toughness and high thermal stability.</p>
YBG302	P15 - P30 M25 - M40	 <p>PVD multilayer coated P10–P30/M10–M25 carbide substrate for finishing to medium machining of stainless steel, super alloys and steel (grooving/milling). Optimised coating stability for higher wear resistance and thermal stability in a wide range of applications.</p>	
			YBG302

**Coated cemented carbide PVD**

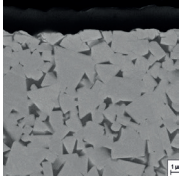
Grade	ISO	Micro structure	Grade description
<b>YBS303</b>	S25 - S35		Milling grade for machining titanium alloys. A tough carbide substrate and the latest PVD coating technology with increased impact resistance and high thermal stability.

**Cermet**

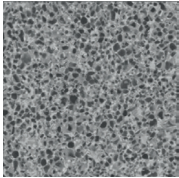
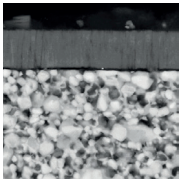
Grade	ISO	Micro structure	Grade description
<b>YNG151</b>	P05 - P15		Uncoated P05-P15 cermet grade for fine finishing operation of steel and stainless steel. Good resistance against plastic deformation for good surface finishing.
<b>YNG151C</b>	P05 - P15		PVD coated P05-P15 cermet grade for fine finishing operation of steel and stainless steel. Good wear resistance and capability against plastic deformation for good surface roughness.

**Uncoated cemented carbide**

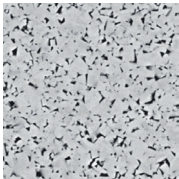
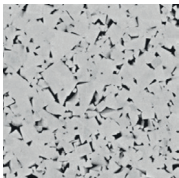
Grade	ISO	Micro structure	Grade description
<b>YD101</b>	N05 - N25 K05 - K20		Uncoated K05-K20/N05-N20 carbide substrate for fine to medium application in aluminum and other material.
<b>YD201</b>	K10 - K30 N10 - N30		Uncoated K10-K30/N10-N30 carbide substrate for medium application in aluminum and other material.

**A**

Turning

**B**

Milling

**C**

Drilling

**D**Technical  
Information**E**

Index



## Application fields of grades – indexable milling

	ISO	HC <sup>1</sup> (CVD)	HC <sup>1</sup> (PVD)	HT	HC <sup>2</sup>	HW	PCBN/PCD
<b>P</b>	P01		YBG102		YNG151C		
	P10		YBG202	YNG151			
	P20	YBC301	YBG205		YNG151C		
	P30	YBC401	YBG302			YC305	
	P40	YBM351	YB9320				
<b>M</b>	M01		YBG102		YNG151C		
	M10	YBM251	YBG202	YNG151			
	M20	YBM253	YBG205		YNG151C		
	M30	YBM351	YBG302			YC305	
	M40	YBC401	YB9320				
<b>K</b>	K01		YBG102				
	K10	YBD152	YBG152				
	K20	YBD252	YBG202			YD201	
	K30						
	K40						
<b>N</b>	N01					YD051	
	N10		YBG101			YD101	
	N20		YBG202				YD201
	N30						
<b>S</b>	S01		YBG102				
	S10		YBG202				
	S20		YBG205				
	S30		YBS203				
			YBS303				
<b>H</b>	H01		YBG102				
	H10						
	H20						
	H30						

<b>P</b>	Steel
<b>M</b>	Stainless steel
<b>K</b>	Cast iron

<b>N</b>	Non-ferrous metals
<b>S</b>	Heat-resistant alloys
<b>H</b>	Hardened materials

HC <sup>1</sup>	Coated carbide
HT	Uncoated cermet
HC <sup>2</sup>	Coated carbide
HW	Uncoated carbide