

## Face milling

FMR02

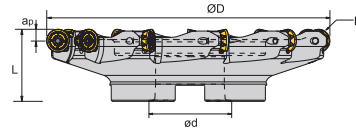
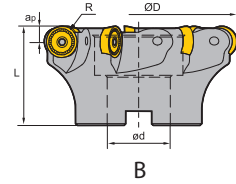
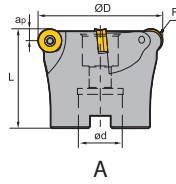
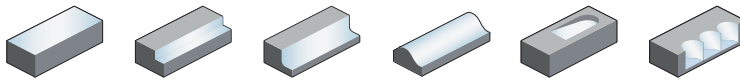

C

Article	*	Stock	Dimensions [mm]					Teeth	Coupling	kg	Inserts
			R	ØD	ød	L	ap <sub>max</sub>				
FMR02-050-A22-RC12-05C	*	●	6	50	22	40	6	5	A	0.7	RCGX1204 RCKT1204 RCMW1204
FMR02-050-A22-RC12-06C	*	○	6	50	22	40	6	6	A	0.7	
FMR02-052-A22-RC12-05C	*	●	6	52	22	40	6	5	A	0.7	
FMR02-063-A22-RC12-04		●	6	63	22	40	6	4	A	0.7	
FMR02-063-A22-RC12-05C	*	●	6	63	22	40	6	5	A	0.7	
FMR02-063-A22-RC12-06		●	6	63	22	40	6	6	A	0.7	
FMR02-063-A22-RC12-06C	*	●	6	63	22	40	6	6	A	0.7	
FMR02-080-A27-RC12-07C	*	●	6	80	27	50	6	7	B	0.7	
FMR02-100-B32-RC12-08C	*	●	6	100	32	50	6	8	B	0.89	
FMR02-063-A22-RC16-04		●	8	63	22	40	8	4	A	0.7	
FMR02-063-A22-RC16-04C	*	○	8	63	22	40	8	4	A	0.7	
FMR02-063-A22-RC16-05C	*	○	8	63	22	40	8	5	A	0.7	
FMR02-066-A27-RC16-05C(FB)	*	●	8	66	27	50	8	5	A	0.5	
FMR02-080-B27-RC16-05		●	8	80	27	50	8	5	B	0.7	
FMR02-080-B27-RC16-07		●	8	80	27	50	8	7	B	0.7	
FMR02-100-B32-RC16-06		●	8	100	32	63	8	6	B	1.2	
FMR02-100-A32-RC16-06C	*	○	8	100	32	63	8	6	B	1.2	
FMR02-125-B40-RC16-07		●	8	125	40	63	8	7	B	2.5	
FMR02-125-B40-RC16-07C	*	○	8	125	40	63	8	7	B	2.5	
FMR02-160-B40-RC16-10(FB)		○	8	160	40	63	8	10	B	3.94	
FMR02-200-C60-RC16-12(FB)		●	8	200	60	63	8	12	C	5.4	
FMR02-080-A27-RC20-04		●	10	80	27	50	10	4	A	0.7	RCKT2006
FMR02-080-A27-RC20-04C(FB)	*	●	10	80	27	50	10	4	A	0.7	
FMR02-100-B32-RC20-05		●	10	100	32	63	10	5	B	1.2	
FMR02-100-B32-RC20-06		●	10	100	32	63	10	6	B	1.2	
FMR02-100-B32-RC20-06C	*	○	10	100	32	63	10	6	B	1.2	
FMR02-125-B32-RC20-05		○	10	125	32	63	10	5	B	1.2	
FMR02-125-B40-RC20-06		●	10	125	40	63	10	6	B	1.2	

● Ex stock ○ On demand

\* With internal cooling



System code > B26

Grade selection > B24

Technical info > B527





Cutting data > B230

# Indexable milling

Article	*	Stock	Dimensions [mm]					Teeth	Coupling		Inserts 
			R	ØD	ød	L	a <sub>p</sub> max				
FMR02-125-B40-RC20-07		●	10	125	40	63	10	7	B	2.2	RCKT2006
FMR02-125-B40-RC20-07C	*	○	10	125	40	63	10	7	B	2.2	
FMR02-160-B40-RC20-08		●	10	160	40	63	10	8	B	4.2	
FMR02-160-B40-RC20-08C	*	○	10	160	40	63	10	8	B	4.2	
FMR02-250-C60-RC20-10		●	10	250	60	63	10	10	C	8.49	
FMR02-250-C60-RC20-11		○	10	250	60	63	10	11	C	8.37	

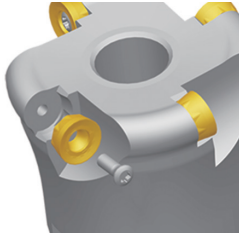
● Ex stock    ○ On demand

\* With internal cooling

Spare parts					
Insert	RCGX1204 RCKT1204 RCMW1204	RCKT1606	RCKT2006	ØD	
	50-100	63-200	80-250		
 Screw (insert)	I60M3.5×10 (2.7 Nm)	I60M5×13 (6.7 Nm)	I43M6×16 (9.1 Nm)		
 Wrench (insert)	WT15IS				
 Wrench (insert)		WT20IT	WT25IT		

System code > B26

Grade selection > B24

Technical info > B527

Cutting data > B230

**A**

Turning

**B**

Milling

**C**



Drilling

**D**

Technical Information





**E**

Index

-  Ideal machining conditions
-  Normal machining conditions
-  Unfavourable machining conditions

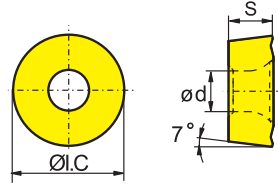
RCKT	I.C	S	d
12 04	12	4.76	4
16 06	16	6.35	5.56
20 06	20	6.35	6.55



## Milling inserts

RC** milling insert		HC <sup>1</sup> (CVD)						HC <sup>1</sup> (PVD)						HT	HC <sup>2</sup>	HW								
	<b>P</b>																							
	<b>M</b>																							
	<b>K</b>																							
	<b>N</b>																							
	<b>S</b>																							
	<b>H</b>																							
ISO		YBC302	YBC301	YBC401	YBM253	YBM251	YBM351	YBD152	YBD252	YBG101	YBG102	YBG202	YBG212	YBS203	YBG205	YB9320	YBG302	YBS303	YBG252	YNG151	YNG151C	YD101	YD201	
	RCKT1204MO-DM	○	○		○	●	○					○			●	○								
	RCKT1606MO-DM		○												●		●							
	RCKT2006MO-DM		○																					
	RCKT1204MO-DR		○	○		○	●								●									
	RCKT1606MO-DR		●	○	●		●	●								●								
	RCKT2006MO-DR		●	○	●		○	●			○						○							
	RCKT1204MO-ER				●																			
	RCKT1606MO-ER				●																			
	RCKT2006MO-ER				●																			
	RCKT1204MO-NM											○												
	RCKT1606MO-NM											○												

● Ex stock    ○ On demand



HC<sup>1</sup> Coated carbide  
 HT Uncoated cermet  
 HC<sup>2</sup> Coated cermet  
 HW Uncoated carbide



-  Ideal machining conditions
-  Normal machining conditions
-  Unfavourable machining conditions

RCGX	I.C	S	d
12 04	12	4.76	4

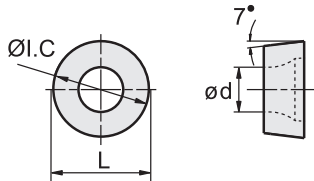
**Milling inserts**

RC** positive insert		HC <sup>1</sup> (CVD)						HC <sup>1</sup> (PVD)						HT	HC <sup>2</sup>	HW								
	<b>P</b>																							
	<b>M</b>																							
	<b>K</b>																							
	<b>N</b>																							
	<b>S</b>																							
	<b>H</b>																							
ISO		YBC302	YBC301	YBC401	YBM253	YBM251	YBM351	YBD152	YBD252	YBG101	YBG102	YBG202	YBG212	YBS203	YBG205	YB9320	YBG302	YBS303	YBG252	YNG151	YNG151C	YD101	YD201	
	RCGX1204MO-LH																							●

● Ex stock    ○ On demand

HC<sup>1</sup> Coated carbide  
 HT Uncoated cermet  
 HC<sup>2</sup> Coated cermet  
 HW Uncoated carbide

**A**

Turning

**B**

Milling

**C**

Drilling

**D**

Technical Information

**E**

Index

System code > B26

Grade selection > B24

Technical info > B527

Cutting data > B230





## FM A 12 050 – A22 O – N 06 – 04 (L) (C)

1 2 3 4 5 6 7 8 9 10 11

Type	
Code	Description
BM	Profile milling
CM	Chamfer milling
EM	Square shoulder milling
FM	Face milling
HM	Helical milling
SM	Slot milling
TM	T-slot milling
XM	Special

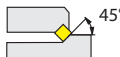
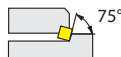
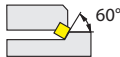
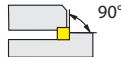
1

Entering angle	
A	
E	
D	
P	
R	

2

Serial number

3





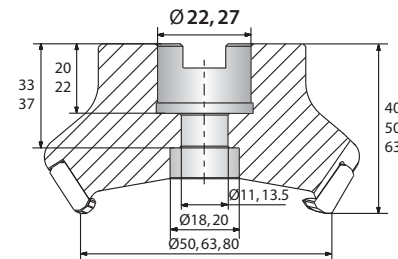
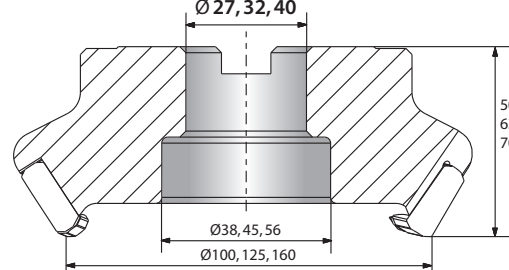
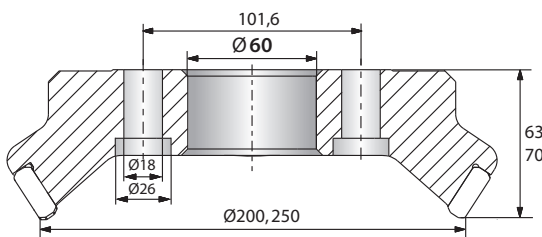
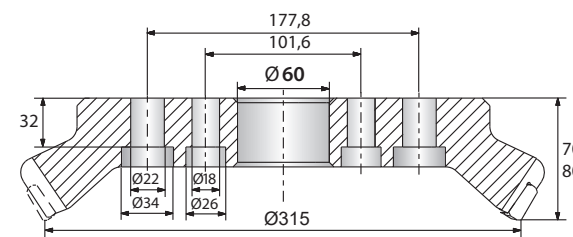





Nominal diameter [mm]	
Code	Description
025	25
050	50
160	160
315	315
...	

4







Type and size of tool holders			
Code	Type	Code	Type
A	<p>Nominal diameter <math>\varnothing 50 - 80</math> mm</p> 	B	<p>Nominal diameter <math>\varnothing 100 - 160</math> mm</p> 
C	<p>Nominal diameter <math>\varnothing 200 - 250</math> mm</p> 	D	<p>Nominal diameter <math>\varnothing 315</math> mm</p> 
G	Straight shank	XP	Weldon shank
K	Bore with keyway		

5









With respect to mounting please adhere to the information provided by the tool holder manufacturer.

Insert shape	
A 	C 
H 	L 
M 	O 
P 	R 
S 	T 
W 	X Special
Z Special	

6

Clearance angle	
B 	C 
D 	E 
F 	N 
P 	

7

Cutting edge length l [mm]	
Insert shape	
	
A	C, M
	
H, O, P	L
	
R	S
	
T	W

8

Number of teeth

9

Cutting direction	
Code	Description
L	Left

10

With inner cooling

11



Tools with B coupling and inner coolant supply require the following spare parts:





Coolant clamp screw



Coolant shower plate



Spare parts (B coupling with inner coolant supply)

		B27	B32	B40	B40
	Ø	80	100	125	160
	Coolant clamp screw	LDB27C	LDB32C	LDB40C	LDB40C
	Coolant shower plate	B27-002-CP	B32-002-CP	B40-002-CP	B40-003-CP

When purchasing tools with inner coolant supply and B coupling these spare parts are included in delivery.

A

Turning

B

Milling

C

Drilling

D

Technical Information

E

Index

**S P K N 12 04 ED T21K R – DM**

**1**

**2**

**3**

**4**

**5**

**6**

**7**

**8**

**9**

**10**

**A**

Turning

**B**

Milling

**C**











Drilling







**D**





Technical Information

**E**

Index

Insert shape	
A 	C 
H 	L 
M 	O 
P 	R 
S 	T 
W 	X Special
Z Special	















Clearance angle	
B 	C 
D 	E 
F 	N 
P 	









Tolerance class			
			
Code	I.C [mm]	m [mm]	S [mm]
A	±0,025	±0,005	±0,025
C	±0,025	±0,013	±0,025
E	±0,025	±0,025	±0,025
F	±0,013	±0,005	±0,025
G	±0,025	±0,025	±0,130
H	±0,013	±0,013	±0,025
J	±0,05-0,13	±0,005	±0,025
K	±0,05-0,13	±0,013	±0,025
L	±0,05-0,13	±0,025	±0,025
M	±0,05-0,13	±0,08-0,18	±0,130
N	±0,05-0,13	±0,08-0,18	±0,025
U	±0,08-0,25	±0,13-0,38	±0,130

**1**

**2**

**3**

Fastening features (metric)	
Insert shape	
A 	B 
C 	F 
G 	H 
J 	M 
N 	Q 
R 	T 
U 	W 
X Special	

Cutting edge length l [mm]	
Insert shape	
	
A	C, M
	
H, O, P	L
	
R	S
	
T	W

**4**

**5**

Insert thickness S [mm]			
Code	S	Code	S
00	0,79	05	5,56
T0	0,99	T5	5,95
01	1,59	06	6,35
T1	1,98	T6	6,75
02	2,38	07	7,94
T2	2,58	09	9,52
03	3,18	T9	9,72
T3	3,97	11	11,11
04	4,76	12	12,70
T4	4,96		

**6**

Angle			
Code	Kr	Code	an
A	45°	A	3°
D	60°	B	5°
E	75°	C	7°
F	85°	D	15°
P	90°	E	20°
Z	Special	F	25°
		G	30°
		N	0°
		P	11°
		Z	Special

**7**

Chamfer							
Code	Type	Code	Angle	Code	Width [mm]	Code	Position
F		0	5°	0	0,10	K	
E		1	10°	1	0,15		
T		2	15°	2	0,20		
S		3	20°	3	0,25		
		4	25°	4	0,30		
		5	30°	5	0,35		
				6	0,40		
				7	0,45		
						W	
						-	

**8**

Cutting direction	
Code	Description
R	Right
L	Left
N	Right and left

**9**

Chip breaker overview  
(on page B20)

**10**

**A**

Turning

**B**

Milling

**C**

Drilling

**D**

Technical Information

**E**

Index



## Guide for recommended cutting data – indexable milling

### Indexable milling – group 1 (FMA07/11/12, FMD02, EMP09/13)

Material group	Composition / structure / heat treatment	Brinell hardness HB	Machining group	Starting values for cutting speed $v_c$ (m/min)								
				HC (CVD)								
				YBC302		YBC401		YBD152		YBD252		
				$a_p / D$		$a_p / D$		$a_p / D$		$a_p / D$		
1/1   3/4		1/5		1/1   3/4		1/5		1/1   3/4		1/5		
P Unalloyed steel	ca. 0,15 % C	annealed	125	1	260	300	225	260				
	ca. 0,45 % C	annealed	190	2	225	255	195	225				
	ca. 0,45 % C	tempered	250	3	210	240	180	210				
	ca. 0,75 % C	annealed	270	4	185	210	160	185				
	ca. 0,75 % C	tempered	300	5	170	195	150	170				
P Low-alloyed steel		annealed	180	6	225	255	195	225				
		tempered	275	7	185	210	160	185				
		tempered	300	8	170	195	150	170				
		tempered	350	9	145	165	125	145				
P High-alloyed steel and high-alloyed tool steel		annealed	200	10	130	150	115	130				
		hardened and tempered	325	11	95	105	80	95				
M Stainless steel	ferritic/martensitic	annealed	200	12								
	martensitic	tempered	240	13								
	austenitic	quench hardened	180	14								
	austenitic-ferritic		230	15								
K Grey cast iron	perlite/ferritic		180	16				370	430	320	370	
	perlite (martensitic)		260	17				220	255	190	220	
K Cast iron with spheroidal graphite	ferritic		160	18				255	295	220	255	
	perlite		250	19				170	200	145	170	
K Malleable cast iron	ferritic		130	20				305	355	265	305	
	perlite		230	21				205	240	175	205	
N Aluminium wrought alloys	cannot be hardened		60	22								
	hardenable	hardened	100	23								
	$\leq 12\% \text{ Si}$ , cannot be hardened		75	24								
	$\leq 12\% \text{ Si}$ , hardenable	hardened	90	25								
N Cast aluminium alloys	$> 12\% \text{ Si}$ , cannot be hardened		130	26								
	machining steel, PB > 1%		110	27								
	CuZn, CuSnZn		90	28								
S Copper and copper alloys (bronze/brass)	CuSn, Pb-free copper, electrolytic copper		100	29								
	Heat-resistant alloys	Fe-based alloys	annealed	200	30							
		hardened	280	31								
	Ni or Co base	annealed	250	32								
hardened		350	33									
Titanium alloys	cast	320	34									
	pure titanium		$R_m$ 400	35								
H Hardened steel	$\alpha$ and $\beta$ alloys	hardened	$R_m$ 1050	36								
	hardened and tempered		55 HRC	37								
H Hard cast iron	hardened and tempered		60 HRC	38								
	cast		400	39								
H Hardened cast iron	hardened and tempered		55 HRC	40								
	Thermoplasts			41								
X Non-metallic materials	Thermosetting plastics			42								
	Plastic, glass-fibre reinforced GFRP			43								
	Plastic, carbon fibre reinforced CFRP			44								
	Graphite			45								
	Wood			46								

Note: The given cutting values are guide values, which were determined under ideal conditions.

The values have to be adapted in individual cases.

Feed rate recommendations on page B248

For examples of material for cutting tool groups view page D22.

**Recommend feed rate**

**Indexable milling – group1 (FMA07/11/12, FMD02, EMP09/13)**

5	Material group	Feed rate per cutting edge [mm]																		
		EMP09			EMP13			EMP13			FMA07			FMA07			FMA11			
		LNKT12			ANGX11			ANGX15			ONHU06			ONHU08			SNEG12			
		Application																		
		F	M	R	F	M	R	F	M	R	F	M	R	F	M	R	F	M	R	
<b>P</b>	Unalloyed steel		0,25	0,50		0,23			0,25		0,19	0,23		0,19	0,23		0,20	0,23		
	Low-alloyed steel		0,23	0,47		0,22			0,23		0,17	0,22		0,17	0,22		0,19	0,21		
	High-alloyed steel and high-alloyed tool steel		0,22	0,44		0,20			0,22		0,16	0,20		0,16	0,20		0,18	0,20		
<b>M</b>	Stainless steel		0,18	0,35													0,14	0,16		
<b>K</b>	Grey cast iron		0,28	0,55		0,26			0,28		0,20	0,26		0,20	0,26		0,22	0,25		
	Cast iron with spheroidal graphite		0,25	0,50		0,23			0,25		0,19	0,23		0,19	0,23		0,20	0,23		
	Malleable cast iron		0,25	0,50		0,23			0,25		0,19	0,23		0,19	0,23		0,20	0,23		
<b>N</b>	Aluminium wrought alloys					0,20			0,21											
	Aluminium-Gusslegierungen					0,20			0,21											
	Copper and copper alloys(bronze/brass)					0,18			0,19											
<b>S</b>	Heat-resistant alloys																			
	Titanium alloys																			
<b>H</b>	Hardened steel																			
	Hard cast iron																			
	Hardened cast iron																			
<b>X</b>	Non-metallic materials																			

1. Select the appropriate product family/cutting data group.
2. Select the used grade.
3. Determine the immersion.
4. Select the used material and read the cutting speed.
5. Please have a look at the detached feed rate recommendations.
6. Select the used tool, the machining mode and the used material.

**A**

Turning

**B**

Milling

**C**

Drilling

**D**

Technical Information

**E**

Index

## Indexable milling – group 3 (FMR01/02/03/04)

	Material group	Composition / structure / heat treatment		Brinell hardness HB	Machining group	Starting values for cutting speed $v_c$ [m/min]							
						HC (CVD)							
						YBC302			YBC401				
						$a_e / D$			$a_e / D$				
1/1   3/4	1/5	1/20	1/1   3/4	1/5	1/20								
P	Unalloyed steel	approx. 0,15 % C	annealed	125	1	260	300	390	225	260	340		
		approx. 0,45 % C	annealed	190	2	225	255	335	195	225	295		
		approx. 0,45 % C	tempered	250	3	210	240	315	180	210	275		
		approx. 0,75 % C	annealed	270	4	185	210	275	160	185	245		
		approx. 0,75 % C	tempered	300	5	170	195	255	150	170	225		
	Low-alloyed steel		annealed	180	6	225	255	335	195	225	295		
			tempered	275	7	185	210	275	160	185	245		
			tempered	300	8	170	195	255	150	170	225		
			tempered	350	9	145	165	215	125	145	190		
	High-alloyed steel and high-alloyed tool steel		annealed	200	10	130	150	195	115	130	170		
		hardened and tempered	325	11	95	105	140	80	95	125			
M	Stainless steel	ferritic/martensitic	annealed	200	12								
			martensitic	tempered	240	13							
			austenitic	quench hardened	180	14							
			austenitic-ferritic		230	15							
K	Grey cast iron	perlitic/ferritic		180	16								
			perlitic (martensitic)		260	17							
	Cast iron with spheroidal graphite	ferritic		160	18								
			perlitic		250	19							
	Malleable cast iron	ferritic		130	20								
			perlitic		230	21							
N	Aluminium wrought alloys	cannot be hardened		60	22								
		hardenable	hardened	100	23								
	Cast aluminium alloys	$\leq 12\% \text{ Si}$ , cannot be hardened		75	24								
		$\leq 12\% \text{ Si}$ , hardenable	hardened	90	25								
		$> 12\% \text{ Si}$ , cannot be hardened		130	26								
	Copper and copper alloys (bronze/brass)	machining steel, PB > 1%		110	27								
		CuZn, CuSnZn		90	28								
CuSn, Pb-free copper, electrolytic copper		100	29										
S	Heat-resistant alloys	Fe-based alloys	annealed	200	30								
			hardened	280	31								
		Ni or Co base	annealed	250	32								
			hardened	350	33								
		cast	320	34									
Titanium alloys	pure titanium		$R_m$ 400	35									
	$\alpha$ and $\beta$ alloys	hardened		$R_m$ 1050	36								
H	Hardened steel		hardened and tempered	55 HRC	37								
			hardened and tempered	60 HRC	38								
	Hard cast iron		cast	400	39								
	Hardened cast iron		hardened and tempered	55 HRC	40								
X	Non-metallic materials	Thermoplasts			41								
		Thermosetting plastics			42								
		Plastic, glass-fibre reinforced GFRP			43								
		Plastic, carbon fibre reinforced CFRP			44								
		Graphite			45								
		Wood			46								

Note: The given cutting values are guide values, which were determined under ideal conditions.  
 The values have to be adapted in individual cases.  
 Feed rate recommendations on page B254.  
 For examples of material for cutting tool groups view page D11.

Starting values for cutting speed $v_c$ [m/min]																						
HC (CVD)									HC (PVD)													
YBD152			YBD252			YBM253			YBG102			YBG152			YB9320			YBG205				
$a_e / D$			$a_e / D$			$a_e / D$			$a_e / D$			$a_e / D$			$a_e / D$			$a_e / D$				
1/1   3/4	1/5	1/20	1/1   3/4	1/5	1/20	1/1   3/4	1/5	1/20	1/1   3/4	1/5	1/20	1/1   3/4	1/5	1/20	1/1   3/4	1/5	1/20	1/1   3/4	1/5	1/20		
								260	300	390	270	315	410	255	295	385	245	285	375	235	275	360
								225	255	335	230	270	355	220	255	335	210	245	320	200	235	310
								210	240	315	220	255	335	205	240	315	200	230	300	190	220	290
								185	210	275	190	225	295	180	210	275	175	200	260	165	195	255
								170	195	255	180	205	270	170	195	255	160	190	250	155	180	235
								225	255	335	230	270	355	220	255	335	210	245	320	200	235	310
								185	210	275	190	225	295	180	210	275	175	200	260	165	195	255
								170	195	255	180	205	270	170	195	255	160	190	250	155	180	235
								145	165	215	150	175	230	145	165	215	135	160	210	130	155	205
								130	150	195	135	160	210	130	150	195	125	145	190	120	140	185
								95	105	140	95	115	150	90	105	140	90	100	130	85	100	130
								130	150	195	135	160	205	130	150	195	125	145	190	120	140	180
								110	130	165	115	135	175	110	125	165	105	120	160	100	120	155
								140	160	210	145	170	220	140	160	205	130	155	200	125	150	195
								110	130	165	115	135	175	110	125	165	105	120	160	100	120	155
	345	400	520	300	345	450					300	345	450	285	330	430	270	315	410	260	300	390
	210	245	320	180	205	270					180	205	270	170	195	255	160	190	250	155	180	235
	240	280	365	205	240	315					205	240	315	195	225	295	185	215	280	180	210	275
	160	185	245	135	160	210					135	160	210	130	150	195	125	145	190	120	140	185
	285	330	430	245	285	375					245	285	375	230	270	355	225	260	340	215	250	325
	190	220	290	165	190	250					165	190	250	155	180	235	150	175	230	145	165	215

HC Coated carbide  
 HT Uncoated carbide, main component (TiC) o. (TiN), cermet  
 HC<sub>1</sub> Coated cermet  
 HW Uncoated carbide, main component (WC)

**A**  
Turning  
**B**  
Milling  
**C**  
Drilling  
**D**  
Technical Information  
**E**  
Index

## Indexable milling – group 3 (FMR01/02/03/04)

	Material group	Composition / structure / heat treatment		Brinell hardness HB	Machining group	Starting values for cutting speed $v_c$ [m/min]						
						HC (PVD)						
						YBG212			YBG252			
						$a_e / D$		$a_e / D$		$a_e / D$		
	1/1   3/4	1/5	1/20	1/1   3/4	1/5	1/20						
<b>P</b>	Unalloyed steel	approx. 0,15 % C	annealed	125	1	240	280	365	230	265	345	
		approx. 0,45 % C	annealed	190	2	205	240	315	200	230	300	
		approx. 0,45 % C	tempered	250	3	195	225	295	185	215	280	
		approx. 0,75 % C	annealed	270	4	170	200	260	165	190	250	
		approx. 0,75 % C	tempered	300	5	160	185	245	150	175	230	
	Low-alloyed steel		annealed	180	6	205	240	315	200	230	300	
			tempered	275	7	170	200	260	165	190	250	
			tempered	300	8	160	185	245	150	175	230	
			tempered	350	9	135	155	205	130	150	195	
	High-alloyed steel and high-alloyed tool steel		annealed	200	10	120	140	185	115	135	180	
		hardened and tempered	325	11	85	100	130	85	95	125		
<b>M</b>	Stainless steel	ferritic/martensitic	annealed	200	12	120	140	185	115	135	175	
			martensitic	tempered	240	13	105	120	155	100	115	145
			austenitic	quench hardened	180	14	130	150	195	125	145	185
			austenitic-ferritic		230	15	105	120	155	100	115	145
<b>K</b>	Grey cast iron	perlitic/ferritic		180	16	265	305	400	255	295	385	
		perlitic (martensitic)		260	17	160	185	245	150	175	230	
	Cast iron with spheroidal graphite	ferritic		160	18	180	210	275	175	200	260	
		perlitic		250	19	120	140	185	115	135	180	
	Malleable cast iron	ferritic		130	20	220	255	335	210	240	315	
		perlitic		230	21	145	170	225	140	160	210	
<b>N</b>	Aluminium wrought alloys	cannot be hardened		60	22							
		hardenable	hardened	100	23							
	Cast aluminium alloys	$\leq 12\% \text{ Si}$ , cannot be hardened		75	24							
		$\leq 12\% \text{ Si}$ , hardenable	hardened	90	25							
		$> 12\% \text{ Si}$ , cannot be hardened		130	26							
	Copper and copper alloys (bronze/brass)	machining steel, PB > 1%		110	27							
		CuZn, CuSnZn		90	28							
		CuSn, Pb-free copper, electrolytic copper		100	29							
<b>S</b>	Heat-resistant alloys	Fe-based alloys	annealed	200	30							
			hardened	280	31							
		Ni or Co base	annealed	250	32							
			hardened	350	33							
		cast	320	34								
	Titanium alloys	pure titanium	$R_m$ 400	35								
	$\alpha$ and $\beta$ alloys	hardened	$R_m$ 1050	36								
<b>H</b>	Hardened steel	hardened and tempered		55 HRC	37							
		hardened and tempered		60 HRC	38							
	Hard cast iron	cast		400	39							
	Hardened cast iron	hardened and tempered		55 HRC	40							
<b>X</b>	Non-metallic materials	Thermoplasts			41							
		Thermosetting plastics			42							
		Plastic, glass-fibre reinforced GFRP			43							
		Plastic, carbon fibre reinforced CFRP			44							
		Graphite			45							
		Wood			46							

Note: The given cutting values are guide values, which were determined under ideal conditions.  
 The values have to be adapted in individual cases.  
 Feed rate recommendations on page B254.  
 For examples of material for cutting tool groups view page D11.



## Recommended feed rate

### Indexable milling – group 2 (FMA01/02/03/04, FME01/02, FMP01/02, EMP01/02/03/04)

Material group		Feed rate per cutting edge [mm]																	
		FMA01   FMA02			FMA03			FMA03			FMA04			FMA04			FMA04		
		SEET12			SEKN12			SEKN15			OFKT05			OFKR07			ODHT06		
		Application																	
		F	M	R	F	M	R	F	M	R	F	M	R	F	M	R	F	M	R
<b>P</b>	Unalloyed steel	0,15	0,20	0,25		0,18			0,20		0,20	0,25		0,20	0,25		0,20	0,25	
	Low-alloyed steel	0,14	0,19	0,23		0,17			0,19		0,19	0,23		0,19	0,23		0,19	0,23	
	High-alloyed steel and high-alloyed tool steel	0,13	0,18	0,22		0,16			0,18		0,18	0,22		0,18	0,22		0,18	0,22	
<b>M</b>	Stainless steel	0,11	0,14	0,18		0,13			0,14		0,14	0,18		0,14	0,18		0,14	0,18	
<b>K</b>	Grey cast iron	0,17	0,22	0,28		0,20			0,22		0,22	0,28		0,22	0,28		0,22	0,28	
	Cast iron with spheroidal graphite	0,15	0,20	0,25		0,18			0,20		0,20	0,25		0,20	0,25		0,20	0,25	
	Malleable cast iron	0,15	0,20	0,25		0,18			0,20		0,20	0,25		0,20	0,25		0,20	0,25	
<b>N</b>	Aluminium wrought alloys	0,13	0,17	0,21							0,17	0,21		0,17	0,21		0,17	0,21	
	Aluminum cast alloys	0,13	0,17	0,21							0,17	0,21		0,17	0,21		0,17	0,21	
	Copper and copper alloys (bronze/brass)	0,11	0,15	0,19							0,15	0,19		0,15	0,19		0,15	0,19	
<b>S</b>	Heat-resistant alloys	0,11	0,14	0,18							0,14	0,18		0,14	0,18		0,14	0,18	
	Titanium alloys	0,11	0,14	0,18							0,14	0,18		0,14	0,18		0,14	0,18	
<b>H</b>	Hardened steel																		
	Hard cast iron																		
	Hardened cast iron																		
<b>X</b>	Non-metallic materials																		

Note: The given cutting values are guide values, which were determined under ideal conditions.  
The values have to be adapted in individual cases.

### Indexable milling – group 3 (FMR01/02/03/04) Face milling

Material group		Feed rate per cutting edge [mm]																	
		FMR01			FMR01			FMR02			FMR02			FMR02			FMR03		
		RCKT10			RC*12			RC*12			RCKT16			RCKT20			RDKW07		
		Application																	
		F	M	R	F	M	R	F	M	R	F	M	R	F	M	R	F	M	R
<b>P</b>	Unalloyed steel		0,20	0,25		0,20	0,25		0,20	0,25		0,23	0,29		0,26	0,33		0,17	
	Low-alloyed steel		0,19	0,23		0,19	0,23		0,19	0,23		0,21	0,27		0,25	0,31		0,16	
	High-alloyed steel and high-alloyed tool steel		0,18	0,22		0,18	0,22		0,18	0,22		0,20	0,25		0,23	0,29		0,15	
<b>M</b>	Stainless steel		0,14	0,18		0,14	0,18		0,14	0,18		0,16	0,20		0,19	0,23		0,12	
<b>K</b>	Grey cast iron		0,22	0,28		0,22	0,28		0,22	0,28		0,25	0,32		0,29	0,36		0,19	
	Cast iron with spheroidal graphite		0,20	0,25		0,20	0,25		0,20	0,25		0,23	0,29		0,26	0,33		0,17	
	Malleable cast iron		0,20	0,25		0,20	0,25		0,20	0,25		0,23	0,29		0,26	0,33		0,17	
<b>N</b>	Aluminium wrought alloys					0,17	0,21		0,17	0,21									
	Aluminum cast alloys					0,17	0,21		0,17	0,21									
	Copper and copper alloys (bronze/brass)					0,15	0,19		0,15	0,19									
<b>S</b>	Heat-resistant alloys																		
	Titanium alloys																		
<b>H</b>	Hardened steel																		
	Hard cast iron																		
	Hardened cast iron																		
<b>X</b>	Non-metallic materials																		

Note: The given cutting values are guide values, which were determined under ideal conditions.  
The values have to be adapted in individual cases.





## Recommended feed rate

### Indexable milling – group 3 (FMR01/02/03/04) Circular milling

Material group	Feed rate per cutting edge [mm]								
	FMR01	FMR01	FMR02	FMR02	FMR02	FMR03			
	RCKT10	RC*12	RC*12	RCKT16	RCKT20	RDKW07			
	Tool diameter [mm]								
	25-32	40-50	50-100	63-125	160-200	80-125	160-250	15	
<b>P</b>	Unalloyed steel	0,12	0,16	0,18	0,24	0,32	0,26	0,35	0,07
	Low-alloyed steel	0,11	0,14	0,16	0,21	0,28	0,23	0,31	0,06
	High-alloyed steel and high-alloyed tool steel	0,10	0,13	0,14	0,19	0,26	0,21	0,28	0,06
<b>M</b>	Stainless steel	0,07	0,09	0,10	0,14	0,18	0,15	0,20	0,04
<b>K</b>	Grey cast iron	0,11	0,14	0,16	0,22	0,29	0,23	0,32	0,06
	Cast iron with spheroidal graphite	0,10	0,13	0,14	0,19	0,26	0,21	0,28	0,06
	Malleable cast iron	0,10	0,13	0,14	0,19	0,26	0,21	0,28	0,06
<b>N</b>	Aluminium wrought alloys								
	Aluminum cast alloys								
	Copper and copper alloys (bronze/brass)								
<b>S</b>	Heat-resistant alloys								
	Titanium alloys								
<b>H</b>	Hardened steel								
	Hard cast iron								
	Hardened cast iron								
<b>X</b>	Non-metallic materials								

Note: The given cutting values are guide values, which were determined under ideal conditions.  
The values have to be adapted in individual cases.











### Indexable milling – group 4 (BMR01/02/03/04, TMP01, CMZ01, CMA01, CMD01)

Material group	Feed rate per cutting edge [mm]									
	BMR01	BMR01	BMR01	BMR01	BMR02	BMR02	BMR02	BMR03	BMR03	
	ZD*08 / SP*06	ZD*11 / SP*06	ZD*13 / SP*09	ZP*22 / SP*12	ROHX12	ROHX16	ROHX20	-	-	
	Tool diameter [mm]									
	20	25	32	40-63	12	16	20	16	20	
<b>P</b>	Unalloyed steel	0,14	0,21	0,26	0,32	0,10	0,13	0,14	0,13	0,14
	Low-alloyed steel	0,10	0,15	0,18	0,22	0,07	0,09	0,10	0,09	0,10
	High-alloyed steel and high-alloyed tool steel	0,09	0,14	0,17	0,21	0,07	0,08	0,09	0,08	0,09
<b>M</b>	Stainless steel	0,08	0,12	0,14	0,18	0,06	0,07	0,08	0,07	0,08
<b>K</b>	Grey cast iron	0,18	0,27	0,34	0,42	0,13	0,17	0,18	0,17	0,18
	Cast iron with spheroidal graphite	0,13	0,20	0,25	0,30	0,10	0,12	0,13	0,12	0,13
	Malleable cast iron	0,14	0,21	0,26	0,32	0,10	0,13	0,14	0,13	0,14
<b>N</b>	Aluminum wrought alloys									
	Aluminum cast alloys									
	Copper and copper alloys (bronze/brass)									
<b>S</b>	Heat-resistant alloys									
	Titanium alloys									
<b>H</b>	Hardened steel									
	Hard cast iron									
	Hardened cast iron									
<b>X</b>	Non-metallic materials									

Note: The given cutting values are guide values, which were determined under ideal conditions.  
The values have to be adapted in individual cases.



## Face milling

Series	Milling body	Inserts	Kr	Application						Features	Page
				P	M	K	N	S	H		
FMR02		 RCGX1204 RCKT1204 RCMW1204 RCKT1606 RCKT2006		✓	✓	✓	✓	✓		<ul style="list-style-type: none"> <li>• Diameter range Ø50 – 250 mm</li> <li>• For steel, stainless steel, cast iron, non-ferrous metals and heatresistant alloys</li> <li>• Screw clamping</li> </ul>	B90
FMR03		 RD**0803 RD**10T3 RD**1204		✓	✓	✓			✓	<ul style="list-style-type: none"> <li>• Diameter range Ø15 – 50 mm</li> <li>• For steel, stainless steel and cast iron</li> <li>• Screw clamping</li> <li>• Mould and die industry</li> </ul>	B94
FMR03		 RDKW0702 RDKW1003		✓	✓	✓			✓	<ul style="list-style-type: none"> <li>• Diameter range Ø15 – 50 mm</li> <li>• For steel, stainless steel and cast iron</li> <li>• Screw clamping</li> <li>• Mould and die industry</li> </ul>	B96
FMR04		 RD**1204 RD**1605 RD**2006		✓	✓	✓			✓	<ul style="list-style-type: none"> <li>• Diameter range Ø50 – 200 mm</li> <li>• For steel, stainless steel and cast iron</li> <li>• Screw clamping</li> <li>• Mould and die industry</li> </ul>	B98
FMR04		 RDKW1003 RDKW12T3 RDKW1604		✓	✓	✓			✓	<ul style="list-style-type: none"> <li>• Diameter range Ø42 – 200 mm</li> <li>• For steel, stainless steel and cast iron</li> <li>• Screw clamping</li> <li>• Mould and die industry</li> </ul>	B100

✓ Very suitable    ✓ Suitable

A

Turning

B

Milling

C

Drilling



D

Technical Information

E

Index

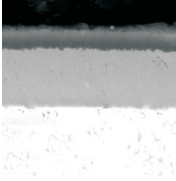
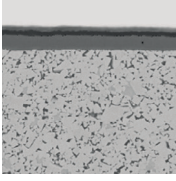
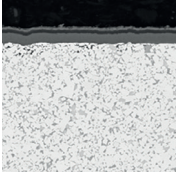
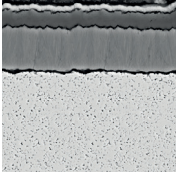
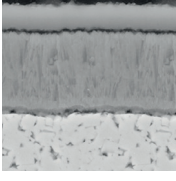
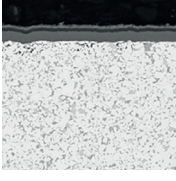
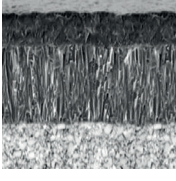
**Coated cemented carbide CVD**

Grade	ISO	Micro structure	Grade description
<b>YBC302</b>	P20 - P35		CVD coated P20-P35 carbide grade for medium operation to roughing of steel at higher cutting speed. Optimal performance of wear resistance and toughness for a wide application field.
<b>YBC301</b>	P20 - P35		CVD coated P20-P35 carbide grade for medium operation to roughing of steel at lower cutting speed.
<b>YBC401</b>	P30 - P50 M30 - M40		CVD coated P30-P50/M30-M40 carbide grade for roughing operation of steel at lower cutting speed and unstable condition.
<b>YBM251</b>	P20 - P30 M15 - M35		CVD coated P20-P30/M15-M35 carbide grade for medium to roughing operation in stainless steel and steel with wide application field. Good wear resistance and capability against plastic deformation at normal cutting speed.
<b>YBM253</b>	M15 - M35		CVD coated M15-M35 carbide grade for medium to roughing operation in stainless steel with wide application field. High wear resistance and capability against plastic deformation at higher cutting speed.
<b>YBM351</b>	P25 - P40 M20 - M40		CVD coated P25-P40/M25-M40 carbide grade for roughing operation in stainless steel and steel. Good wear resistance and edge stability at normal cutting speed.
<b>YBD152</b>	K10 - K25		CVD coated K10-K25 carbide substrate. Optimized for medium to roughing operation of cast iron. Good wear resistance and toughness at higher cutting speed.
<b>YBD252</b>	K20 - K35		CVD coated K20-K35 carbide substrate. Optimized for medium to roughing operation of cast iron and Steel. Good wear resistance and toughness at higher cutting speed.

**A**

Turning

**B**

Milling

**C**

Drilling

**D**Technical  
Information**E**

Index

## Coated cemented carbide PVD

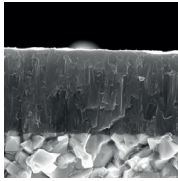
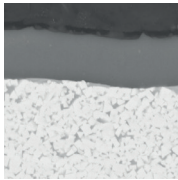
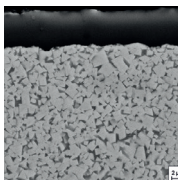
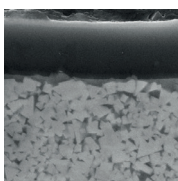
Grade	ISO	Micro structure	Grade description
A Turning	YBG101	N05–N20	 <p>PVD coated N05–N20 carbide substrate for finishing to semi-finishing in aluminium materials. Coating only on the top face, in combination with the aluminium chip breakers, prevents built-up edges and gives a smooth cut.</p>
B Milling	YBG202	P10 - P30 M10-M25	 <p>PVD coated P10–P30/M10–M25 carbide substrate for finishing to medium application of stainless steel and steel (milling). Good wear resistance in a wide application field.</p>
D Technical Information	YBS203	S15 – S25	 <p>Turning and milling grades for processing heat-resistant materials. A special carbon substrate and the latest PVD coating technology enable a very good wear behaviour, high fracture toughness and high thermal stability.</p>
YBG302	P15 - P30 M25 - M40	 <p>PVD multilayer coated P10–P30/M10–M25 carbide substrate for finishing to medium machining of stainless steel, super alloys and steel (grooving/milling). Optimised coating stability for higher wear resistance and thermal stability in a wide range of applications.</p>	
			YBG302

**Coated cemented carbide PVD**

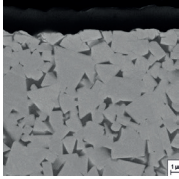
Grade	ISO	Micro structure	Grade description
<b>YBS303</b>	S25 - S35		Milling grade for machining titanium alloys. A tough carbide substrate and the latest PVD coating technology with increased impact resistance and high thermal stability.

**Cermet**

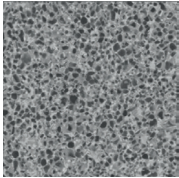
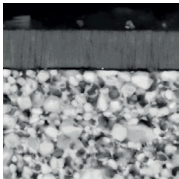
Grade	ISO	Micro structure	Grade description
<b>YNG151</b>	P05 - P15		Uncoated P05-P15 cermet grade for fine finishing operation of steel and stainless steel. Good resistance against plastic deformation for good surface finishing.
<b>YNG151C</b>	P05 - P15		PVD coated P05-P15 cermet grade for fine finishing operation of steel and stainless steel. Good wear resistance and capability against plastic deformation for good surface roughness.

**Uncoated cemented carbide**

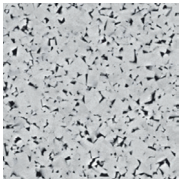
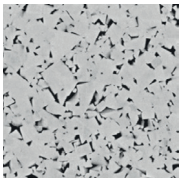
Grade	ISO	Micro structure	Grade description
<b>YD101</b>	N05 - N25 K05 - K20		Uncoated K05-K20/N05-N20 carbide substrate for fine to medium application in aluminum and other material.
<b>YD201</b>	K10 - K30 N10 - N30		Uncoated K10-K30/N10-N30 carbide substrate for medium application in aluminum and other material.

**A**

Turning

**B**

Milling

**C**

Drilling

**D**Technical  
Information**E**

Index

## Application fields of grades – indexable milling

	ISO	HC <sup>1</sup> (CVD)	HC <sup>1</sup> (PVD)	HT	HC <sup>2</sup>	HW	PCBN/PCD
<b>P</b>	P01		YBG102		YNG151C		
	P10		YBG202	YNG151			
	P20	YBC301	YBG205				
	P30	YBC401	YBG302			YC305	
	P40	YBM351	YB9320				
<b>M</b>	M01		YBG102		YNG151C		
	M10	YBM251	YBG202	YNG151			
	M20	YBM253	YBG205				
	M30	YBM351	YBG302			YC305	
	M40	YBC401	YB9320				
<b>K</b>	K01		YBG102				
	K10	YBD152	YBG152				
	K20	YBD252	YBG202			YD201	
	K30						
	K40						
<b>N</b>	N01					YD051	
	N10		YBG101			YD101	
	N20		YBG202				YD201
	N30						
<b>S</b>	S01		YBG102				
	S10		YBG202				
	S20		YBG205				
	S30		YBS203				
			YBS303				
<b>H</b>	H01		YBG102				
	H10						
	H20						
	H30						

<b>P</b>	Steel
<b>M</b>	Stainless steel
<b>K</b>	Cast iron

<b>N</b>	Non-ferrous metals
<b>S</b>	Heat-resistant alloys
<b>H</b>	Hardened materials

HC <sup>1</sup>	Coated carbide
HT	Uncoated cermet
HC <sup>2</sup>	Coated carbide
HW	Uncoated carbide