

Face milling

FMP02 Kr: 90°

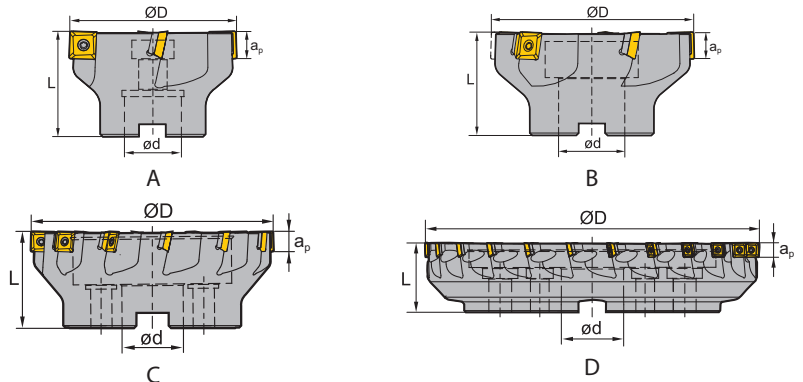
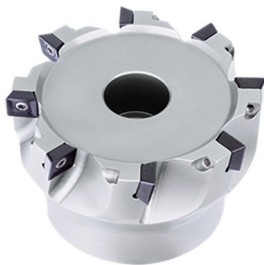
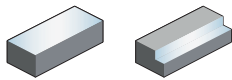

| Article | * | Stock | Dimensions [mm] | | | | Teeth | Coupling | kg | Inserts |
|------------------------|---|-------|-----------------|----|----|--------------------|-------|----------|-----|----------|
| | | | ØD | ød | L | a _{p max} | | | | |
| FMP02-050-A22-SE09-05 | | ● | 50 | 22 | 40 | 6.7 | 5 | A | 0.3 | SEET09T3 |
| FMP02-050-A22-SE09-05C | * | ● | 50 | 22 | 40 | 6.7 | 5 | A | 0.3 | |
| FMP02-063-A22-SE09-06 | | ● | 63 | 22 | 40 | 6.7 | 6 | A | 0.5 | |
| FMP02-063-A22-SE09-06C | * | ● | 63 | 22 | 40 | 6.7 | 6 | A | 0.5 | |
| FMP02-080-A27-SE09-08 | | ● | 80 | 27 | 50 | 6.7 | 8 | A | 0.9 | |
| FMP02-100-B32-SE09-08 | | ○ | 100 | 32 | 50 | 6.7 | 8 | B | 1.7 | |
| FMP02-100-B32-SE09-10 | | ○ | 100 | 32 | 50 | 6.7 | 10 | B | 1.7 | |
| FMP02-100-B32-SE09-10C | * | ○ | 100 | 32 | 50 | 6.7 | 10 | B | 1.7 | |
| FMP02-125-B40-SE09-12 | | ● | 125 | 40 | 63 | 6.7 | 12 | B | 2.6 | |
| FMP02-125-B40-SE09-12C | * | ○ | 125 | 40 | 63 | 6.7 | 12 | B | 2.6 | |
| FMP02-050-A22-SE12-03 | | ○ | 50 | 22 | 40 | 10.8 | 3 | A | 0.3 | SEET1203 |
| FMP02-050-A22-SE12-03C | * | ○ | 50 | 22 | 40 | 10.8 | 3 | A | 0.3 | |
| FMP02-050-A22-SE12-04 | | ● | 50 | 22 | 40 | 10.8 | 4 | A | 0.3 | |
| FMP02-050-A22-SE12-04C | * | ● | 50 | 22 | 40 | 10.8 | 4 | A | 0.3 | |
| FMP02-050-A22-SE12-05 | | ● | 50 | 22 | 40 | 10.8 | 5 | A | 0.2 | |
| FMP02-050-A22-SE12-05C | * | ○ | 50 | 22 | 40 | 10.8 | 5 | A | 0.2 | |
| FMP02-063-A22-SE12-04 | | ○ | 63 | 22 | 40 | 10.8 | 4 | A | 0.4 | |
| FMP02-063-A22-SE12-05 | | ● | 63 | 22 | 40 | 10.8 | 5 | A | 0.4 | |
| FMP02-063-A22-SE12-05C | * | ● | 63 | 22 | 40 | 10.8 | 5 | A | 0.4 | |
| FMP02-063-A22-SE12-06 | | ● | 63 | 22 | 40 | 10.8 | 6 | A | 0.4 | |
| FMP02-063-A22-SE12-06C | * | ○ | 63 | 22 | 40 | 10.8 | 6 | A | 0.4 | |
| FMP02-080-A27-SE12-04 | | ○ | 80 | 27 | 50 | 10.8 | 4 | A | 0.9 | |
| FMP02-080-A27-SE12-06 | | ● | 80 | 27 | 50 | 10.8 | 6 | A | 0.8 | |
| FMP02-080-A27-SE12-06C | * | ● | 80 | 27 | 50 | 10.8 | 6 | A | 0.8 | |
| FMP02-080-A27-SE12-08 | | ● | 80 | 27 | 50 | 10.8 | 8 | A | 0.8 | |
| FMP02-080-A27-SE12-08C | * | ○ | 80 | 27 | 50 | 10.8 | 8 | A | 0.8 | |
| FMP02-100-B32-SE12-05 | | ● | 100 | 32 | 50 | 10.8 | 5 | B | 1.2 | |
| FMP02-100-B32-SE12-07 | | ● | 100 | 32 | 50 | 10.8 | 7 | B | 1.2 | |
| FMP02-100-B32-SE12-10 | | ● | 100 | 32 | 50 | 10.8 | 10 | B | 1.2 | |

● Ex stock ○ On demand

* With internal cooling

System code > B26

Grade selection > B24







Technical info > B527

Cutting data > B230

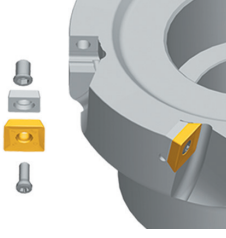

| Article | * | Stock | Dimensions [mm] | | | | Teeth | Coupling | kg | Inserts  |
|------------------------|---|-------|-----------------|----|----|--------------------|-------|----------|------|--|
| | | | ØD | ød | L | a _p max | | | | |
| FMP02-100-B32-SE12-10C | * | ○ | 100 | 32 | 50 | 10.8 | 10 | B | 1.2 | SEET1203 |
| FMP02-125-B40-SE12-06 | | ○ | 125 | 40 | 63 | 10.8 | 6 | B | 3.1 | |
| FMP02-125-B40-SE12-08 | | ● | 125 | 40 | 63 | 10.8 | 8 | B | 3 | |
| FMP02-125-B40-SE12-08C | * | ○ | 125 | 40 | 63 | 10.8 | 8 | B | 3 | |
| FMP02-125-B40-SE12-12 | | ● | 125 | 40 | 63 | 10.8 | 12 | B | 2.9 | |
| FMP02-160-C40-SE12-08 | | ● | 160 | 40 | 63 | 10.8 | 8 | C | 4.1 | |
| FMP02-160-C40-SE12-12 | | ● | 160 | 40 | 63 | 10.8 | 12 | C | 3.9 | |
| FMP02-250-C60-SE12-12 | | ○ | 250 | 60 | 63 | 10.8 | 12 | C | 11.1 | |
| FMP02-250-C60-SE12-18 | | ● | 250 | 60 | 63 | 10.8 | 18 | C | 10.9 | |
| FMP02-315-D60-SE12-24 | | ○ | 315 | 60 | 63 | 10.8 | 24 | D | 21.6 | |

● Ex stock ○ On demand











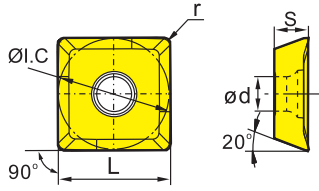

* With internal cooling

| Spare parts | | | | |  |
|---|---------------------|------------------------|------------------------|----------|--|
| Insert | SEET09T3 | SEET1203 | SEET1203 | SEET1203 | |
| ØD | 50-125 | 50 | 63-315 | | |
|  Screw (insert) | I60M3×7 (1.8 Nm) | I60M3.5×10 (2.7 Nm) | I60M3.5×12 (2.7 Nm) | | |
|  Screw (shim) | | | SM5×7XA | | |
|  Shim | | | S12BSX | | |
|  Wrench (shim) | | | WH35L | | |
|  Wrench (insert) | WT09IS | WT15IS | WT15IS | | |

Milling inserts

-  Ideal machining conditions
-  Normal machining conditions
-  Unfavourable machining conditions

| SEET | L | I.C | S | d |
|-------|--------|--------|------|-----|
| 09 T3 | 9.525 | 9.525 | 4.01 | 3.3 |
| 12 03 | 13.308 | 13.308 | 4.04 | 4.1 |

| SE** milling insert | HC ¹ (CVD) | | | | | | HC ¹ (PVD) | | | HT | HC ² | HW | | | | | | | | | | | |
|---|---|---|---|---|---|---|---|---|---|---|---|--------|--------|--------|--------|--------|--------|--------|--------|--------|---------|-------|-------|
| | P | M | K | N | S | H | | | | | | | | | | | | | | | | | |
|  |  |  |  |  |  |  |  |  |  |  |  | | | | | | | | | | | | |
| ISO | r | YBC302 | YBC301 | YBC401 | YBM253 | YBM251 | YBM351 | YBD152 | YBD252 | YBG101 | YBG102 | YBG202 | YBG212 | YBS203 | YBG205 | YB9320 | YBG302 | YBS303 | YBG252 | YNG151 | YNG151C | YD101 | YD201 |
|  SEET09T308PER-APF | 0.8 | | | | | ○ | | | | | | | | | ● | | | | | | | | |

● Ex stock ○ On demand

HC¹ Coated carbide
 HT Uncoated cermet
 HC² Coated cermet
 HW Uncoated carbide

A
Turning
B
Milling
C
Drilling
D
Technical Information
E
Index

Indexable milling Face milling

A

Turning

B

Milling

C

Drilling

D

Technical Information

E

Index

- Ideal machining conditions
- Normal machining conditions
- Unfavourable machining conditions

| SEET | L | I.C | S | d |
|-------|--------|--------|------|-----|
| 09 T3 | 9.525 | 9.525 | 4.01 | 3.3 |
| 12 03 | 13.308 | 13.308 | 4.04 | 4.1 |

Milling inserts

| SE** milling insert | | HC ¹ (CVD) | | | | | | HC ¹ (PVD) | | | | | HT | HC ² | HW | | | | | | | | | |
|---------------------|-------------------|-----------------------|----------|----------|--------|--------|--------|-----------------------|----------|----------|--------|--------|--------|-----------------|--------|--------|--------|--------|--------|--------|--------|---------|-------|-------|
| | | P | ●●●●●●●● | | | | | | ●●●●●●●● | | | | | ●● | ● | | | | | | | | | |
| | | M | ●●●●●●●● | | | | | | ●●●●●●●● | | | | | ●● | ● | | | | | | | | | |
| | | K | | ●●●●●●●● | | | | | | ●●●●●●●● | | | | | ●● | | ●● | | | | | | | |
| | | N | | ●●●●●●●● | | | | | | ●●●●●●●● | | | | | | | ●● | | | | | | | |
| | | S | | ●●●●●●●● | | | | | | ●●●●●●●● | | | | | | | | | | | | | | |
| | | H | | ●●●●●●●● | | | | | | ●●●●●●●● | | | | | | | | | | | | | | |
| ISO | | r | YBC302 | YBC301 | YBC401 | YBM253 | YBM251 | YBM351 | YBD152 | YBD252 | YBG101 | YBG102 | YBG202 | YBG212 | YBS203 | YBG205 | YB9320 | YBG302 | YBS303 | YBG252 | YNG151 | YNG151C | YD101 | YD201 |
| | SEET09T308PER-APM | 0.8 | | | | | ○ | | | | | | | | | ● | | | | | | | | |
| | SEET09T308PER-APR | 0.8 | | | | | ○ | | | | | | | | | ○ | | | | | | | | |
| | SEET120308PER-APF | 0.8 | | | | | ○ | | | | ○ | | | | | ● | | | | | | | | |
| | SEET120308PER-APM | 0.8 | | | | | ● | | | | ○ | | | | | ● | | | | | | | | |
| | SEET120308PER-APR | 0.8 | | | | | ● | | | | ○ | | | | | ● | | | | | | | | |
| | SEET120308-LH | 0.8 | | | | | | | | ○ | ○ | | | | | | | | | | | | | ● |
| | SEET09T308PER-PF | 0.8 | | | | | | | | | | ○ | | | | | | | | | | | | |
| | SEET120308PER-PF | 0.8 | ○ | | | | | | | | | | | | | | | | | | | | | |
| | SEET09T308PER-PM | 0.8 | | | | | | ○ | | | ○ | | | | | | | | | | | | | |
| | SEET120308PER-PM | 0.8 | ○ | | | ○ | ○ | ○ | ○ | | ○ | ○ | | | | | ○ | | | | | | | |
| | SEET09T308PER-PR | 0.8 | | | | | | ○ | | | | | | | | | ○ | | | | | | | |
| | SEET120308PER-PR | 0.8 | ○ | | | ○ | ○ | ○ | | | ○ | ○ | | | | | ○ | | | | | | | |

● Ex stock ○ On demand

HC¹ Coated carbide
 HT Uncoated cermet
 HC² Coated cermet
 HW Uncoated carbide





FM A 12 050 – A22 O – N 06 – 04 (L) (C)

1 2 3 4 5 6 7 8 9 10 11

| Type | |
|------|-------------------------|
| Code | Description |
| BM | Profile milling |
| CM | Chamfer milling |
| EM | Square shoulder milling |
| FM | Face milling |
| HM | Helical milling |
| SM | Slot milling |
| TM | T-slot milling |
| XM | Special |

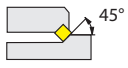
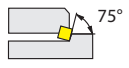
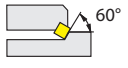
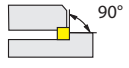
1

| Entering angle | | | |
|----------------|--|---|---|
| A |  | E |  |
| D |  | P |  |
| R |  | | |

2

| |
|---------------|
| Serial number |
|---------------|

3





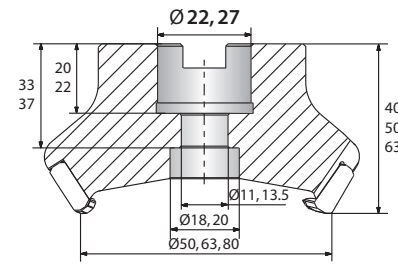
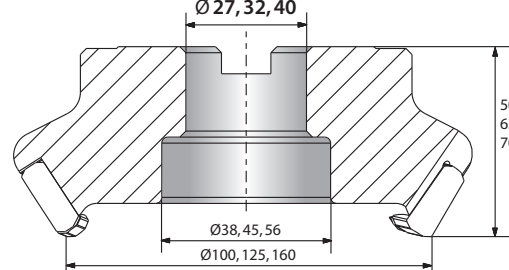
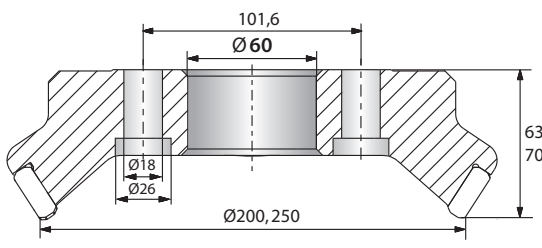





| Nominal diameter [mm] | |
|-----------------------|-------------|
| Code | Description |
| 025 | 25 |
| 050 | 50 |
| 160 | 160 |
| 315 | 315 |
| ... | |

4







| Type and size of tool holders | | | |
|-------------------------------|--|------|---|
| Code | Type | Code | Type |
| A | Nominal diameter $\varnothing 50 - 80$ mm  | B | Nominal diameter $\varnothing 100 - 160$ mm  |
| | Nominal diameter $\varnothing 200 - 250$ mm  | | D |
| G | Straight shank | XP | Weldon shank |
| K | Bore with keyway | | |

5









With respect to mounting please adhere to the information provided by the tool holder manufacturer.

| Insert shape | |
|---|---|
| A  | C  |
| H  | L  |
| M  | O  |
| P  | R  |
| S  | T  |
| W  | X Special |
| Z Special | |

6

| Clearance angle | |
|---|---|
| B  | C  |
| D  | E  |
| F  | N  |
| P  | |

7

| Cutting edge length l [mm] | |
|---|---|
| Insert shape | |
|  |  |
| A | C, M |
|  |  |
| H, O, P | L |
|  |  |
| R | S |
|  |  |
| T | W |

8

| Number of teeth |
|-----------------|
| |

9

| Cutting direction | |
|-------------------|-------------|
| Code | Description |
| L | Left |

10

| With inner cooling |
|--------------------|
| |

11



Tools with B coupling and inner coolant supply require the following spare parts:





Coolant clamp screw



Coolant shower plate



Spare parts (B coupling with inner coolant supply)

| | | B27 | B32 | B40 | B40 |
|---|----------------------|------------|------------|------------|------------|
| | Ø | 80 | 100 | 125 | 160 |
|  | Coolant clamp screw | LDB27C | LDB32C | LDB40C | LDB40C |
|  | Coolant shower plate | B27-002-CP | B32-002-CP | B40-002-CP | B40-003-CP |

When purchasing tools with inner coolant supply and B coupling these spare parts are included in delivery.

A

Turning

B

Milling

C

Drilling

D

Technical Information

E

Index

S P K N 12 04 ED T21K R – DM

1

2

3

4

5

6

7

8

9

10

A

Turning

B

Milling

C











Drilling







D





Technical Information

E

Index

| Insert shape | |
|---|---|
| A  | C  |
| H  | L  |
| M  | O  |
| P  | R  |
| S  | T  |
| W  | X Special |
| Z Special | |















| Clearance angle | |
|---|---|
| B  | C  |
| D  | E  |
| F  | N  |
| P  | |









| Tolerance class | | | |
|--|---|---|---|
|  |  |  |  |
| Code | I.C [mm] | m [mm] | S [mm] |
| A | ±0,025 | ±0,005 | ±0,025 |
| C | ±0,025 | ±0,013 | ±0,025 |
| E | ±0,025 | ±0,025 | ±0,025 |
| F | ±0,013 | ±0,005 | ±0,025 |
| G | ±0,025 | ±0,025 | ±0,130 |
| H | ±0,013 | ±0,013 | ±0,025 |
| J | ±0,05-0,13 | ±0,005 | ±0,025 |
| K | ±0,05-0,13 | ±0,013 | ±0,025 |
| L | ±0,05-0,13 | ±0,025 | ±0,025 |
| M | ±0,05-0,13 | ±0,08-0,18 | ±0,130 |
| N | ±0,05-0,13 | ±0,08-0,18 | ±0,025 |
| U | ±0,08-0,25 | ±0,13-0,38 | ±0,130 |

1

2

3

| Fastening features (metric) | |
|---|---|
| Insert shape | |
| A  | B  |
| C  | F  |
| G  | H  |
| J  | M  |
| N  | Q  |
| R  | T  |
| U  | W  |
| X Special | |

| Cutting edge length l [mm] | |
|---|---|
| Insert shape | |
|  |  |
| A | C, M |
|  |  |
| H, O, P | L |
|  |  |
| R | S |
|  |  |
| T | W |

4

5

| Insert thickness S [mm] | | | |
|-------------------------|------|------|-------|
| | | | |
| Code | S | Code | S |
| 00 | 0,79 | 05 | 5,56 |
| T0 | 0,99 | T5 | 5,95 |
| 01 | 1,59 | 06 | 6,35 |
| T1 | 1,98 | T6 | 6,75 |
| 02 | 2,38 | 07 | 7,94 |
| T2 | 2,58 | 09 | 9,52 |
| 03 | 3,18 | T9 | 9,72 |
| T3 | 3,97 | 11 | 11,11 |
| 04 | 4,76 | 12 | 12,70 |
| T4 | 4,96 | | |

6

| Angle | | | |
|-------|---------|------|---------|
| | | | |
| Code | Kr | Code | an |
| A | 45° | A | 3° |
| D | 60° | B | 5° |
| E | 75° | C | 7° |
| F | 85° | D | 15° |
| P | 90° | E | 20° |
| Z | Special | F | 25° |
| | | G | 30° |
| | | N | 0° |
| | | P | 11° |
| | | Z | Special |

7

| Chamfer | | | | | | | |
|---------|------|------|-------|------|------------|------|----------|
| Code | Type | Code | Angle | Code | Width [mm] | Code | Position |
| F | | 0 | 5° | 0 | 0,10 | K | |
| E | | 1 | 10° | 1 | 0,15 | | |
| T | | 2 | 15° | 2 | 0,20 | | |
| S | | 3 | 20° | 3 | 0,25 | | |
| | | 4 | 25° | 4 | 0,30 | | |
| | | 5 | 30° | 5 | 0,35 | | |
| | | | | 6 | 0,40 | | |
| | | | | 7 | 0,45 | | |
| | | | | | | W | |
| | | | | | | - | |

8

| Cutting direction | |
|-------------------|----------------|
| Code | Description |
| R | Right |
| L | Left |
| N | Right and left |

9

Chip breaker overview
(on page B20)

10

A

Turning

B

Milling

C

Drilling

D

Technical Information

E

Index

Guide for recommended cutting data – indexable milling

Indexable milling – group 1 (FMA07/11/12, FMD02, EMP09/13)

| Material group | Composition / structure / heat treatment | Brinell hardness HB | Machining group | Starting values for cutting speed v_c (m/min) | | | | | | | | |
|---|---|-----------------------|---------------------|---|-----|-----------|-----|-----------|-----|-----------|-----|--|
| | | | | HC (CVD) | | | | | | | | |
| | | | | YBC302 | | YBC401 | | YBD152 | | YBD252 | | |
| | | | | a_p / D | | a_p / D | | a_p / D | | a_p / D | | |
| 1/1 3/4 | | 1/5 | | 1/1 3/4 | | 1/5 | | 1/1 3/4 | | 1/5 | | |
| P Unalloyed steel | ca. 0,15 % C | annealed | 125 | 1 | 260 | 300 | 225 | 260 | | | | |
| | ca. 0,45 % C | annealed | 190 | 2 | 225 | 255 | 195 | 225 | | | | |
| | ca. 0,45 % C | tempered | 250 | 3 | 210 | 240 | 180 | 210 | | | | |
| | ca. 0,75 % C | annealed | 270 | 4 | 185 | 210 | 160 | 185 | | | | |
| | ca. 0,75 % C | tempered | 300 | 5 | 170 | 195 | 150 | 170 | | | | |
| P Low-alloyed steel | | annealed | 180 | 6 | 225 | 255 | 195 | 225 | | | | |
| | | tempered | 275 | 7 | 185 | 210 | 160 | 185 | | | | |
| | | tempered | 300 | 8 | 170 | 195 | 150 | 170 | | | | |
| | | tempered | 350 | 9 | 145 | 165 | 125 | 145 | | | | |
| P High-alloyed steel and high-alloyed tool steel | | annealed | 200 | 10 | 130 | 150 | 115 | 130 | | | | |
| | | hardened and tempered | 325 | 11 | 95 | 105 | 80 | 95 | | | | |
| M Stainless steel | ferritic/martensitic | annealed | 200 | 12 | | | | | | | | |
| | martensitic | tempered | 240 | 13 | | | | | | | | |
| | austenitic | quench hardened | 180 | 14 | | | | | | | | |
| | austenitic-ferritic | | 230 | 15 | | | | | | | | |
| K Grey cast iron | perlite/ferritic | | 180 | 16 | | | | 370 | 430 | 320 | 370 | |
| | perlite (martensitic) | | 260 | 17 | | | | 220 | 255 | 190 | 220 | |
| K Cast iron with spheroidal graphite | ferritic | | 160 | 18 | | | | 255 | 295 | 220 | 255 | |
| | perlite | | 250 | 19 | | | | 170 | 200 | 145 | 170 | |
| K Malleable cast iron | ferritic | | 130 | 20 | | | | 305 | 355 | 265 | 305 | |
| | perlite | | 230 | 21 | | | | 205 | 240 | 175 | 205 | |
| N Aluminium wrought alloys | cannot be hardened | | 60 | 22 | | | | | | | | |
| | hardenable | hardened | 100 | 23 | | | | | | | | |
| | ≤ 12 % Si, cannot be hardened | | 75 | 24 | | | | | | | | |
| | ≤ 12 % Si, hardenable | hardened | 90 | 25 | | | | | | | | |
| N Cast aluminium alloys | > 12 % Si, cannot be hardened | | 130 | 26 | | | | | | | | |
| | machining steel, PB > 1% | | 110 | 27 | | | | | | | | |
| | CuZn, CuSnZn | | 90 | 28 | | | | | | | | |
| S Copper and copper alloys (bronze/brass) | CuSn, Pb-free copper, electrolytic copper | | 100 | 29 | | | | | | | | |
| | Heat-resistant alloys | Fe-based alloys | annealed | 200 | 30 | | | | | | | |
| | | hardened | 280 | 31 | | | | | | | | |
| | Ni or Co base | annealed | 250 | 32 | | | | | | | | |
| hardened | | 350 | 33 | | | | | | | | | |
| Titanium alloys | cast | 320 | 34 | | | | | | | | | |
| | pure titanium | | R _m 400 | 35 | | | | | | | | |
| H Hardened steel | α and β alloys | hardened | R _m 1050 | 36 | | | | | | | | |
| | hardened and tempered | | 55 HRC | 37 | | | | | | | | |
| H Hard cast iron | hardened and tempered | | 60 HRC | 38 | | | | | | | | |
| | cast | | 400 | 39 | | | | | | | | |
| X Non-metallic materials | hardened and tempered | | 55 HRC | 40 | | | | | | | | |
| | Thermoplasts | | | 41 | | | | | | | | |
| | Thermosetting plastics | | | 42 | | | | | | | | |
| | Plastic, glass-fibre reinforced GFRP | | | 43 | | | | | | | | |
| | Plastic, carbon fibre reinforced CFRP | | | 44 | | | | | | | | |
| Graphite | | | 45 | | | | | | | | | |
| Wood | | | 46 | | | | | | | | | |

Note: The given cutting values are guide values, which were determined under ideal conditions. The values have to be adapted in individual cases. Feed rate recommendations on page B248. For examples of material for cutting tool groups view page D22.

Recommend feed rate

Indexable milling – group1 (FMA07/11/12, FMD02, EMP09/13)

| 5 | Material group | Feed rate per cutting edge [mm] | | | | | | | | | | | | | | | | | |
|----------|--|---------------------------------|------|------|--------|------|---|--------|------|---|--------|------|---|--------|------|---|--------|------|------|
| | | EMP09 | | | EMP13 | | | EMP13 | | | FMA07 | | | FMA07 | | | FMA11 | | |
| | | LNKT12 | | | ANGX11 | | | ANGX15 | | | ONHU06 | | | ONHU08 | | | SNEG12 | | |
| | | Application | | | | | | | | | | | | | | | | | |
| | | F | M | R | F | M | R | F | M | R | F | M | R | F | M | R | F | M | R |
| P | Unalloyed steel | | 0,25 | 0,50 | | 0,23 | | | 0,25 | | 0,19 | 0,23 | | 0,19 | 0,23 | | | 0,20 | 0,23 |
| | Low-alloyed steel | | 0,23 | 0,47 | | 0,22 | | | 0,23 | | 0,17 | 0,22 | | 0,17 | 0,22 | | | 0,19 | 0,21 |
| | High-alloyed steel and high-alloyed tool steel | | 0,22 | 0,44 | | 0,20 | | | 0,22 | | 0,16 | 0,20 | | 0,16 | 0,20 | | | 0,18 | 0,20 |
| M | Stainless steel | | 0,18 | 0,35 | | | | | | | | | | | | | | 0,14 | 0,16 |
| K | Grey cast iron | | 0,28 | 0,55 | | 0,26 | | | 0,28 | | 0,20 | 0,26 | | 0,20 | 0,26 | | | 0,22 | 0,25 |
| | Cast iron with spheroidal graphite | | 0,25 | 0,50 | | 0,23 | | | 0,25 | | 0,19 | 0,23 | | 0,19 | 0,23 | | | 0,20 | 0,23 |
| | Malleable cast iron | | 0,25 | 0,50 | | 0,23 | | | 0,25 | | 0,19 | 0,23 | | 0,19 | 0,23 | | | 0,20 | 0,23 |
| N | Aluminium wrought alloys | | | | | 0,20 | | | 0,21 | | | | | | | | | | |
| | Aluminium-Gusslegierungen | | | | | 0,20 | | | 0,21 | | | | | | | | | | |
| | Copper and copper alloys(bronze/brass) | | | | | 0,18 | | | 0,19 | | | | | | | | | | |
| S | Heat-resistant alloys | | | | | | | | | | | | | | | | | | |
| | Titanium alloys | | | | | | | | | | | | | | | | | | |
| H | Hardened steel | | | | | | | | | | | | | | | | | | |
| | Hard cast iron | | | | | | | | | | | | | | | | | | |
| | Hardened cast iron | | | | | | | | | | | | | | | | | | |
| X | Non-metallic materials | | | | | | | | | | | | | | | | | | |

1. Select the appropriate product family/cutting data group.
2. Select the used grade.
3. Determine the immersion.
4. Select the used material and read the cutting speed.
5. Please have a look at the detached feed rate recommendations.
6. Select the used tool, the machining mode and the used material.

A

Turning

B

Milling

C

Drilling

D

Technical Information

E

Index

Indexable milling – group 2 (FMA01/02/03/04, FME01/02, FMP01/02, EMP01/02/03/04)

| | Material group | Composition / structure / heat treatment | | Brinell hardness HB | Machining group | Starting values for cutting speed v_c [m/min] | | | | | | | | |
|-----------------------------|---|---|--|-----------------------|-----------------------|---|-----|-----------|-----|-----------|-----|-----------|-----|--|
| | | | | | | HC (CVD) | | | | | | | | |
| | | | | | | YBC302 | | YBC401 | | YBD152 | | YBD252 | | |
| | | | | | | a_e / D | | a_e / D | | a_e / D | | a_e / D | | |
| 1/1 3/4 | | 1/5 | | 1/1 3/4 | | 1/5 | | 1/1 3/4 | | 1/5 | | | | |
| A Turning | P Unalloyed steel | approx. 0,15 % C | annealed | 125 | 1 | 245 | 285 | 210 | 245 | | | | | |
| | | approx. 0,45 % C | annealed | 190 | 2 | 210 | 245 | 180 | 210 | | | | | |
| | | approx. 0,45 % C | tempered | 250 | 3 | 200 | 230 | 170 | 200 | | | | | |
| | | approx. 0,75 % C | annealed | 270 | 4 | 175 | 200 | 150 | 175 | | | | | |
| | | approx. 0,75 % C | tempered | 300 | 5 | 160 | 190 | 140 | 160 | | | | | |
| | B Milling | P Low-alloyed steel | | annealed | 180 | 6 | 210 | 245 | 180 | 210 | | | | |
| | | | | tempered | 275 | 7 | 175 | 200 | 150 | 175 | | | | |
| | | | | tempered | 300 | 8 | 160 | 190 | 140 | 160 | | | | |
| | | | tempered | 350 | 9 | 135 | 160 | 120 | 135 | | | | | |
| C Drilling | P High-alloyed steel and high-alloyed tool steel | | annealed | 200 | 10 | 125 | 145 | 105 | 125 | | | | | |
| | | | hardened and tempered | 325 | 11 | 90 | 100 | 75 | 90 | | | | | |
| M Milling | M Stainless steel | ferritic/martensitic | annealed | 200 | 12 | | | | | | | | | |
| | | | martensitic | tempered | 240 | 13 | | | | | | | | |
| | | | austenitic | quench hardened | 180 | 14 | | | | | | | | |
| | | | austenitic-ferritic | | 230 | 15 | | | | | | | | |
| K Milling | K Grey cast iron | perlitic/ferritic | | 180 | 16 | | | | | 315 | 365 | 270 | 315 | |
| | | | perlitic (martensitic) | | 260 | 17 | | | | 185 | 215 | 160 | 190 | |
| | K Cast iron with spheroidal graphite | ferritic | | 160 | 18 | | | | | 215 | 250 | 185 | 215 | |
| | | | perlitic | | 250 | 19 | | | | 145 | 170 | 125 | 145 | |
| | K Malleable cast iron | ferritic | | 130 | 20 | | | | | 260 | 300 | 225 | 260 | |
| | | | perlitic | | 230 | 21 | | | | 175 | 205 | 150 | 175 | |
| N Drilling | N Aluminium wrought alloys | cannot be hardened | | 60 | 22 | | | | | | | | | |
| | | | hardenable | hardened | 100 | 23 | | | | | | | | |
| | N Cast aluminium alloys | $\leq 12\% \text{ Si}$, cannot be hardened | | | 75 | 24 | | | | | | | | |
| | | | $\leq 12\% \text{ Si}$, hardenable | hardened | 90 | 25 | | | | | | | | |
| | | | $> 12\% \text{ Si}$, cannot be hardened | | | 130 | 26 | | | | | | | |
| | N Copper and copper alloys (bronze/brass) | machining steel, PB > 1% | | | 110 | 27 | | | | | | | | |
| | | CuZn, CuSnZn | | | 90 | 28 | | | | | | | | |
| | | CuSn, Pb-free copper, electrolytic copper | | | 100 | 29 | | | | | | | | |
| S Milling | S Heat-resistant alloys | Fe-based alloys | annealed | 200 | 30 | | | | | | | | | |
| | | | | hardened | 280 | 31 | | | | | | | | |
| | | Ni or Co base | annealed | 250 | 32 | | | | | | | | | |
| | | | | hardened | 350 | 33 | | | | | | | | |
| | | | cast | 320 | 34 | | | | | | | | | |
| | S Titanium alloys | pure titanium | | | R_m 400 | 35 | | | | | | | | |
| α and β alloys | | hardened | R_m 1050 | 36 | | | | | | | | | | |
| H Milling | H Hardened steel | | | hardened and tempered | 55 HRC | 37 | | | | | | | | |
| | | | | hardened and tempered | 60 HRC | 38 | | | | | | | | |
| | H Hard cast iron | | | | cast | 400 | 39 | | | | | | | |
| | H Hardened cast iron | | | | hardened and tempered | 55 HRC | 40 | | | | | | | |
| X Milling | X Non-metallic materials | Thermoplasts | | | | 41 | | | | | | | | |
| | | Thermosetting plastics | | | | 42 | | | | | | | | |
| | | Plastic, glass-fibre reinforced GFRP | | | | 43 | | | | | | | | |
| | | Plastic, carbon fibre reinforced CFRP | | | | 44 | | | | | | | | |
| | | Graphite | | | | 45 | | | | | | | | |
| | | Wood | | | | 46 | | | | | | | | |

Note: The given cutting values are guide values, which were determined under ideal conditions.
 The values have to be adapted in individual cases.
 Feed rate recommendations on page B254.
 For examples of material for cutting tool groups view page D11.

A
Turning
B
Milling
C
Drilling
D
Technical Information
E
Index

| Starting values for cutting speed v_c [m/min] | | | | | | | | | | | | | | | | | | | | | |
|---|-----|-----------|------|-----------|-----|-----------|-----|-----------|-----|-----------|-----|-----------|-----|-----------|-----|-----------|------|-----------|------|-----------|-----|
| HC (CVD) | | | | HC (PVD) | | | | | | | | | | | | HW | | | | HT | |
| YBM253 | | YBG101 | | YBG102 | | YBG152 | | YB9320 | | YBG205 | | YBG252 | | YBG302 | | YD101 | | YD201 | | YNG151 | |
| a_e / D | | a_e / D | | a_e / D | | a_e / D | | a_e / D | | a_e / D | | a_e / D | | a_e / D | | a_e / D | | a_e / D | | a_e / D | |
| 1/1 3/4 | 1/5 | 1/1 3/4 | 1/5 | 1/1 3/4 | 1/5 | 1/1 3/4 | 1/5 | 1/1 3/4 | 1/5 | 1/1 3/4 | 1/5 | 1/1 3/4 | 1/5 | 1/1 3/4 | 1/5 | 1/1 3/4 | 1/5 | 1/1 3/4 | 1/5 | 1/1 3/4 | 1/5 |
| 245 | 285 | | | 255 | 295 | 240 | 280 | 230 | 265 | 220 | 255 | 215 | 250 | 210 | 245 | | | | | 270 | 315 |
| 210 | 245 | | | 220 | 255 | 205 | 240 | 200 | 230 | 190 | 220 | 185 | 215 | 180 | 210 | | | | | 235 | 270 |
| 200 | 230 | | | 205 | 240 | 195 | 225 | 185 | 215 | 180 | 205 | 175 | 200 | 170 | 200 | | | | | 220 | 255 |
| 175 | 200 | | | 180 | 210 | 170 | 200 | 165 | 190 | 155 | 180 | 155 | 175 | 150 | 175 | | | | | 195 | 220 |
| 160 | 190 | | | 170 | 195 | 160 | 185 | 150 | 175 | 145 | 170 | 140 | 165 | 140 | 160 | | | | | 180 | 210 |
| 210 | 245 | | | 220 | 255 | 205 | 240 | 200 | 230 | 190 | 220 | 185 | 215 | 180 | 210 | | | | | 235 | 270 |
| 175 | 200 | | | 180 | 210 | 170 | 200 | 165 | 190 | 155 | 180 | 155 | 175 | 150 | 175 | | | | | 195 | 220 |
| 160 | 190 | | | 170 | 195 | 160 | 185 | 150 | 175 | 145 | 170 | 140 | 165 | 140 | 160 | | | | | 180 | 210 |
| 135 | 160 | | | 145 | 165 | 135 | 155 | 130 | 150 | 125 | 145 | 120 | 140 | 120 | 135 | | | | | 150 | 180 |
| 125 | 145 | | | 130 | 150 | 120 | 140 | 115 | 135 | 110 | 130 | 110 | 125 | 105 | 125 | | | | | 140 | 160 |
| 90 | 100 | | | 90 | 105 | 85 | 100 | 85 | 95 | 80 | 90 | 80 | 90 | 75 | 90 | | | | | 100 | 110 |
| 125 | 145 | | | 130 | 150 | 120 | 140 | 115 | 135 | 110 | 130 | 110 | 125 | 105 | 125 | | | | | 135 | 160 |
| 105 | 120 | | | 110 | 125 | 105 | 120 | 100 | 115 | 95 | 110 | 95 | 105 | 90 | 105 | | | | | 115 | 135 |
| 130 | 155 | | | 140 | 160 | 130 | 150 | 125 | 145 | 120 | 140 | 115 | 135 | 115 | 130 | | | | | 145 | 170 |
| 105 | 120 | | | 110 | 125 | 105 | 120 | 100 | 115 | 95 | 110 | 95 | 105 | 90 | 105 | | | | | 115 | 135 |
| | | | | 285 | 330 | 265 | 305 | 255 | 295 | 245 | 285 | 240 | 280 | 235 | 275 | | | | | | |
| | | | | 170 | 195 | 160 | 185 | 150 | 175 | 145 | 170 | 140 | 165 | 140 | 160 | | | | | | |
| | | | | 195 | 225 | 180 | 210 | 175 | 200 | 165 | 195 | 165 | 190 | 160 | 185 | | | | | | |
| | | | | 130 | 150 | 120 | 140 | 115 | 135 | 110 | 130 | 110 | 125 | 105 | 125 | | | | | | |
| | | | | 230 | 270 | 220 | 255 | 210 | 240 | 200 | 230 | 195 | 225 | 190 | 225 | | | | | | |
| | | | | 155 | 180 | 145 | 170 | 140 | 160 | 135 | 155 | 130 | 150 | 130 | 150 | | | | | | |
| | | 1505 | 1735 | | | | | | | | | | | | | 1205 | 1390 | 1040 | 1200 | | |
| | | 1225 | 1420 | | | | | | | | | | | | | 980 | 1140 | 850 | 980 | | |
| | | 540 | 620 | | | | | | | | | | | | | 435 | 500 | 375 | 435 | | |
| | | 435 | 505 | | | | | | | | | | | | | 350 | 405 | 300 | 350 | | |
| | | 220 | 255 | | | | | | | | | | | | | 180 | 205 | 155 | 180 | | |
| | | 170 | 195 | | | | | | | | | | | | | 140 | 160 | 120 | 140 | | |
| | | 210 | 245 | | | | | | | | | | | | | 170 | 200 | 150 | 170 | | |
| | | 385 | 445 | | | | | | | | | | | | | 310 | 360 | 265 | 310 | | |
| | | | | 75 | 85 | 70 | 80 | 65 | 75 | 65 | 75 | 65 | 75 | 60 | 70 | | | | | | |
| | | | | 50 | 55 | 50 | 55 | 45 | 50 | 45 | 50 | 45 | 50 | 40 | 45 | | | | | | |
| | | | | 60 | 70 | 55 | 65 | 55 | 65 | 50 | 55 | 50 | 55 | 50 | 55 | | | | | | |
| | | | | 35 | 40 | 35 | 40 | 30 | 35 | 30 | 35 | 30 | 35 | 30 | 35 | | | | | | |
| | | | | 45 | 50 | 45 | 50 | 40 | 45 | 40 | 45 | 40 | 45 | 40 | 45 | | | | | | |
| | | | | 75 | 85 | 70 | 80 | 65 | 75 | 65 | 75 | 65 | 75 | 60 | 70 | | | | | | |
| | | | | 75 | 85 | 70 | 80 | 65 | 75 | 65 | 75 | 65 | 75 | 60 | 70 | | | | | | |

HC Coated carbide
 HT Uncoated carbide, main component (TiC) o. (TiN), cermet
 HC₁ Coated cermet
 HW Uncoated carbide, main component (WC)

A

Turning

B

Milling

C

Drilling

D

Technical Information

E

Index

Indexable milling – group 2 (FMA01/02/03/04, FME01/02, FMP01/02, EMP01/02/03/04)

| Material group | Composition / structure / heat treatment | | Brinell hardness HB | Machining group | Starting values for cutting speed vc [m/min] | | | | |
|---|---|------------------------------|-----------------------|-----------------|--|-----|-----------------|--|--|
| | | | | | HC ₁ | | YNG151C | | |
| | | | | | a _e / D | | 1/1 3/4 1/5 | | |
| P Unalloyed steel | approx. 0,15 % C | annealed | 125 | 1 | 285 | 335 | | | |
| | approx. 0,45 % C | annealed | 190 | 2 | 250 | 285 | | | |
| | approx. 0,45 % C | tempered | 250 | 3 | 235 | 270 | | | |
| | approx. 0,75 % C | annealed | 270 | 4 | 205 | 235 | | | |
| | approx. 0,75 % C | tempered | 300 | 5 | 190 | 225 | | | |
| P Low-alloyed steel | | annealed | 180 | 6 | 250 | 285 | | | |
| | | tempered | 275 | 7 | 205 | 235 | | | |
| | | tempered | 300 | 8 | 190 | 225 | | | |
| | | tempered | 350 | 9 | 160 | 190 | | | |
| P High-alloyed steel and high-alloyed tool steel | | annealed | 200 | 10 | 150 | 170 | | | |
| | | hardened and tempered | 325 | 11 | 105 | 120 | | | |
| M Stainless steel | ferritic/martensitic | annealed | 200 | 12 | 145 | 170 | | | |
| | martensitic | tempered | 240 | 13 | 120 | 145 | | | |
| | austenitic | quench hardened | 180 | 14 | 155 | 180 | | | |
| | austenitic-ferritic | | 230 | 15 | 120 | 145 | | | |
| K Grey cast iron | | perlitic/ferritic | 180 | 16 | | | | | |
| | | perlitic (martensitic) | 260 | 17 | | | | | |
| K Cast iron with spheroidal graphite | | ferritic | 160 | 18 | | | | | |
| | | perlitic | 250 | 19 | | | | | |
| K Malleable cast iron | | ferritic | 130 | 20 | | | | | |
| | | perlitic | 230 | 21 | | | | | |
| N Aluminium wrought alloys | cannot be hardened | | 60 | 22 | | | | | |
| | hardenable | hardened | 100 | 23 | | | | | |
| | Cast aluminium alloys | ≤ 12% Si, cannot be hardened | | 75 | 24 | | | | |
| | | ≤ 12% Si, hardenable | hardened | 90 | 25 | | | | |
| | | > 12% Si, cannot be hardened | | 130 | 26 | | | | |
| N Copper and copper alloys (bronze/brass) | machining steel, PB> 1% | | 110 | 27 | | | | | |
| | CuZn, CuSnZn | | 90 | 28 | | | | | |
| | CuSn, Pb-free copper, electrolytic copper | | 100 | 29 | | | | | |
| S Heat-resistant alloys | Fe-based alloys | annealed | 200 | 30 | | | | | |
| | | hardened | 280 | 31 | | | | | |
| | Ni or Co bass | annealed | 250 | 32 | | | | | |
| | | hardened | 350 | 33 | | | | | |
| | | cast | 320 | 34 | | | | | |
| S Titanium alloys | pure titanium | | R _m 400 | 35 | | | | | |
| | α and β alloys | hardened | R _m 1050 | 36 | | | | | |
| H Hardened steel | | | | | | | | | |
| | | | hardened and tempered | 55 HRC | 37 | | | | |
| | | | hardened and tempered | 60 HRC | 38 | | | | |
| H Hard cast iron | | | cast | 400 | 39 | | | | |
| H Hardened cast iron | | | hardened and tempered | 55 HRC | 40 | | | | |
| X Non-metallic materials | Thermoplasts | | | | 41 | | | | |
| | Thermosetting plastics | | | | 42 | | | | |
| | Plastic, glass-fibre reinforced GFRP | | | | 43 | | | | |
| | Plastic, carbon fibre reinforced CFRP | | | | 44 | | | | |
| | Graphite | | | | 45 | | | | |
| | Wood | | | | 46 | | | | |

Note: The given cutting values are guide values, which were determined under ideal conditions.
 The values have to be adapted in individual cases.
 Feed rate recommendations on page B254.
 For examples of material for cutting tool groups view page D11.

A

Turning

B

Milling

C

Drilling

D

Technical Information

E

Index

Recommended feed rate

Indexable milling – group 2 (FMA01/02/03/04, FME01/02, FMP01/02, EMP01/02/03/04)

| Material group | | Feed rate per cutting edge [mm] | | | | | | | | | | | | | | | | | |
|----------------|--|---------------------------------|------|------|--------|------|---|--------|------|---|--------|------|---|--------|------|---|--------|------|---|
| | | FMA01 FMA02 | | | FMA03 | | | FMA03 | | | FMA04 | | | FMA04 | | | FMA04 | | |
| | | SEET12 | | | SEKN12 | | | SEKN15 | | | OFKT05 | | | OFKR07 | | | ODHT06 | | |
| | | Application | | | | | | | | | | | | | | | | | |
| | | F | M | R | F | M | R | F | M | R | F | M | R | F | M | R | F | M | R |
| P | Unalloyed steel | 0,15 | 0,20 | 0,25 | | 0,18 | | | 0,20 | | 0,20 | 0,25 | | 0,20 | 0,25 | | 0,20 | 0,25 | |
| | Low-alloyed steel | 0,14 | 0,19 | 0,23 | | 0,17 | | | 0,19 | | 0,19 | 0,23 | | 0,19 | 0,23 | | 0,19 | 0,23 | |
| | High-alloyed steel and high-alloyed tool steel | 0,13 | 0,18 | 0,22 | | 0,16 | | | 0,18 | | 0,18 | 0,22 | | 0,18 | 0,22 | | 0,18 | 0,22 | |
| M | Stainless steel | 0,11 | 0,14 | 0,18 | | 0,13 | | | 0,14 | | 0,14 | 0,18 | | 0,14 | 0,18 | | 0,14 | 0,18 | |
| K | Grey cast iron | 0,17 | 0,22 | 0,28 | | 0,20 | | | 0,22 | | 0,22 | 0,28 | | 0,22 | 0,28 | | 0,22 | 0,28 | |
| | Cast iron with spheroidal graphite | 0,15 | 0,20 | 0,25 | | 0,18 | | | 0,20 | | 0,20 | 0,25 | | 0,20 | 0,25 | | 0,20 | 0,25 | |
| | Malleable cast iron | 0,15 | 0,20 | 0,25 | | 0,18 | | | 0,20 | | 0,20 | 0,25 | | 0,20 | 0,25 | | 0,20 | 0,25 | |
| N | Aluminium wrought alloys | 0,13 | 0,17 | 0,21 | | | | | | | 0,17 | 0,21 | | 0,17 | 0,21 | | 0,17 | 0,21 | |
| | Aluminum cast alloys | 0,13 | 0,17 | 0,21 | | | | | | | 0,17 | 0,21 | | 0,17 | 0,21 | | 0,17 | 0,21 | |
| | Copper and copper alloys (bronze/brass) | 0,11 | 0,15 | 0,19 | | | | | | | 0,15 | 0,19 | | 0,15 | 0,19 | | 0,15 | 0,19 | |
| S | Heat-resistant alloys | 0,11 | 0,14 | 0,18 | | | | | | | 0,14 | 0,18 | | 0,14 | 0,18 | | 0,14 | 0,18 | |
| | Titanium alloys | 0,11 | 0,14 | 0,18 | | | | | | | 0,14 | 0,18 | | 0,14 | 0,18 | | 0,14 | 0,18 | |
| H | Hardened steel | | | | | | | | | | | | | | | | | | |
| | Hard cast iron | | | | | | | | | | | | | | | | | | |
| | Hardened cast iron | | | | | | | | | | | | | | | | | | |
| X | Non-metallic materials | | | | | | | | | | | | | | | | | | |

Note: The given cutting values are guide values, which were determined under ideal conditions.
The values have to be adapted in individual cases.

Indexable milling – group 3 (FMR01/02/03/04) Face milling

| Material group | | Feed rate per cutting edge [mm] | | | | | | | | | | | | | | | | | |
|----------------|--|---------------------------------|------|------|-------|------|------|-------|------|------|--------|------|------|--------|------|------|--------|------|---|
| | | FMR01 | | | FMR01 | | | FMR02 | | | FMR02 | | | FMR02 | | | FMR03 | | |
| | | RCKT10 | | | RC*12 | | | RC*12 | | | RCKT16 | | | RCKT20 | | | RDKW07 | | |
| | | Application | | | | | | | | | | | | | | | | | |
| | | F | M | R | F | M | R | F | M | R | F | M | R | F | M | R | F | M | R |
| P | Unalloyed steel | | 0,20 | 0,25 | | 0,20 | 0,25 | | 0,20 | 0,25 | | 0,23 | 0,29 | | 0,26 | 0,33 | | 0,17 | |
| | Low-alloyed steel | | 0,19 | 0,23 | | 0,19 | 0,23 | | 0,19 | 0,23 | | 0,21 | 0,27 | | 0,25 | 0,31 | | 0,16 | |
| | High-alloyed steel and high-alloyed tool steel | | 0,18 | 0,22 | | 0,18 | 0,22 | | 0,18 | 0,22 | | 0,20 | 0,25 | | 0,23 | 0,29 | | 0,15 | |
| M | Stainless steel | | 0,14 | 0,18 | | 0,14 | 0,18 | | 0,14 | 0,18 | | 0,16 | 0,20 | | 0,19 | 0,23 | | 0,12 | |
| K | Grey cast iron | | 0,22 | 0,28 | | 0,22 | 0,28 | | 0,22 | 0,28 | | 0,25 | 0,32 | | 0,29 | 0,36 | | 0,19 | |
| | Cast iron with spheroidal graphite | | 0,20 | 0,25 | | 0,20 | 0,25 | | 0,20 | 0,25 | | 0,23 | 0,29 | | 0,26 | 0,33 | | 0,17 | |
| | Malleable cast iron | | 0,20 | 0,25 | | 0,20 | 0,25 | | 0,20 | 0,25 | | 0,23 | 0,29 | | 0,26 | 0,33 | | 0,17 | |
| N | Aluminium wrought alloys | | | | | 0,17 | 0,21 | | 0,17 | 0,21 | | | | | | | | | |
| | Aluminum cast alloys | | | | | 0,17 | 0,21 | | 0,17 | 0,21 | | | | | | | | | |
| | Copper and copper alloys (bronze/brass) | | | | | 0,15 | 0,19 | | 0,15 | 0,19 | | | | | | | | | |
| S | Heat-resistant alloys | | | | | | | | | | | | | | | | | | |
| | Titanium alloys | | | | | | | | | | | | | | | | | | |
| H | Hardened steel | | | | | | | | | | | | | | | | | | |
| | Hard cast iron | | | | | | | | | | | | | | | | | | |
| | Hardened cast iron | | | | | | | | | | | | | | | | | | |
| X | Non-metallic materials | | | | | | | | | | | | | | | | | | |

Note: The given cutting values are guide values, which were determined under ideal conditions.
The values have to be adapted in individual cases.

| Feed rate per cutting edge [mm] | | | | | | | | | | | | | | | | | | | | | | | | | | |
|---------------------------------|------|---|--------|------|---|--------|------|---|--------|------|---|--------|------|------|---------------|------|------|---------------|------|------|---------------|------|------|---|---|---|
| FME02 | | | FME03 | | | FME03 | | | FMP01 | | | FMP02 | | | EMP01 EMP02 | | | EMP01 EMP02 | | | EMP03 EMP04 | | | | | |
| SPK*12 | | | SPK*12 | | | SPK*15 | | | TPKN22 | | | SEET12 | | | APKT11 | | | APKT16 | | | APKT11 | | | | | |
| Application | | | | | | | | | | | | | | | | | | | | | | | | | | |
| F | M | R | F | M | R | F | M | R | F | M | R | F | M | R | F | M | R | F | M | R | F | M | R | F | M | R |
| | 0,20 | | | 0,19 | | | 0,20 | | | 0,20 | | 0,15 | 0,20 | 0,25 | 0,10 | 0,15 | 0,20 | 0,12 | 0,17 | 0,23 | 0,10 | 0,20 | 0,25 | | | |
| | 0,19 | | | 0,17 | | | 0,19 | | | 0,19 | | 0,14 | 0,19 | 0,23 | 0,09 | 0,14 | 0,19 | 0,11 | 0,16 | 0,21 | 0,09 | 0,19 | 0,23 | | | |
| | 0,18 | | | 0,16 | | | 0,18 | | | 0,18 | | 0,13 | 0,18 | 0,22 | 0,09 | 0,13 | 0,18 | 0,10 | 0,15 | 0,20 | 0,09 | 0,18 | 0,22 | | | |
| | 0,14 | | | 0,13 | | | 0,14 | | | 0,14 | | 0,11 | 0,14 | 0,18 | 0,07 | 0,11 | 0,14 | 0,08 | 0,12 | 0,16 | 0,07 | 0,14 | 0,18 | | | |
| | 0,22 | | | 0,20 | | | 0,22 | | | 0,22 | | 0,17 | 0,22 | 0,28 | 0,11 | 0,17 | 0,22 | 0,13 | 0,19 | 0,25 | 0,11 | 0,22 | 0,28 | | | |
| | 0,20 | | | 0,19 | | | 0,20 | | | 0,20 | | 0,15 | 0,20 | 0,25 | 0,10 | 0,15 | 0,20 | 0,12 | 0,17 | 0,23 | 0,10 | 0,20 | 0,25 | | | |
| | 0,20 | | | 0,19 | | | 0,20 | | | 0,20 | | 0,15 | 0,20 | 0,25 | 0,10 | 0,15 | 0,20 | 0,12 | 0,17 | 0,23 | 0,10 | 0,20 | 0,25 | | | |
| | | | | | | | | | | | | 0,13 | 0,17 | 0,21 | 0,09 | 0,13 | 0,17 | 0,10 | 0,15 | 0,20 | 0,09 | 0,17 | 0,21 | | | |
| | | | | | | | | | | | | 0,13 | 0,17 | 0,21 | 0,09 | 0,13 | 0,17 | 0,10 | 0,15 | 0,20 | 0,09 | 0,17 | 0,21 | | | |
| | | | | | | | | | | | | 0,11 | 0,15 | 0,19 | 0,08 | 0,11 | 0,15 | 0,09 | 0,13 | 0,18 | 0,08 | 0,15 | 0,19 | | | |

F Finishing
M Medium machining
R Roughing













| Feed rate per cutting edge [mm] | | | | | | | | | | | | | | |
|---------------------------------|------|---|-------|------|---|-------|------|------|--------|------|------|--------|------|------|
| FMR03 | | | FMR03 | | | FMR04 | | | FMR04 | | | FMR04 | | |
| RDKW08 | | | RD*10 | | | RD*12 | | | RDKW16 | | | RDKW20 | | |
| Application | | | | | | | | | | | | | | |
| F | M | R | F | M | R | F | M | R | F | M | R | F | M | R |
| | 0,17 | | | 0,20 | | 0,15 | 0,20 | 0,25 | 0,17 | 0,23 | 0,29 | 0,2 | 0,26 | 0,33 |
| | 0,16 | | | 0,19 | | 0,14 | 0,19 | 0,23 | 0,16 | 0,21 | 0,27 | 0,19 | 0,25 | 0,31 |
| | 0,15 | | | 0,18 | | 0,13 | 0,18 | 0,22 | 0,15 | 0,20 | 0,25 | 0,18 | 0,23 | 0,29 |
| | 0,12 | | | 0,14 | | 0,11 | 0,14 | 0,18 | 0,12 | 0,16 | 0,20 | 0,14 | 0,19 | 0,23 |
| | 0,19 | | | 0,22 | | 0,17 | 0,22 | 0,28 | 0,19 | 0,25 | 0,32 | 0,22 | 0,29 | 0,36 |
| | 0,17 | | | 0,20 | | 0,15 | 0,20 | 0,25 | 0,17 | 0,23 | 0,29 | 0,20 | 0,26 | 0,33 |
| | 0,17 | | | 0,20 | | 0,15 | 0,20 | 0,25 | 0,17 | 0,23 | 0,29 | 0,20 | 0,26 | 0,33 |
| | | | | 0,17 | | 0,13 | 0,17 | 0,21 | | | | | | |
| | | | | 0,17 | | 0,13 | 0,17 | 0,21 | | | | | | |
| | | | | 0,15 | | 0,11 | 0,15 | 0,19 | | | | | | |

F Finishing
M Medium machining
R Roughing

A
Turning
B
Milling
C
Drilling
D
Technical Information
E
Index

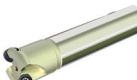

Face milling

| Series | Milling body | Inserts | Kr | Application | | | | | | Features | Page |
|--------|---|---|-----|-------------|---|---|---|---|---|--|------|
| | | | | P | M | K | N | S | H | | |
| FMP02 |  |  SEET09T3 SEET1203 | 90° | ✓ | ✓ | ✓ | ✓ | ✓ | | <ul style="list-style-type: none"> • Diameter range Ø50 – 315 mm • For steel, stainless steel, cast iron an non-ferrous metals • Screw clamping | B76 |
| FMP03 |  |  LNKT120608-ZR LNKT1506EN-ZR LNKT2007DN-ZR LNKT2510-ZR | 89° | ✓ | | ✓ | | | | <ul style="list-style-type: none"> • Diameter range Ø50 – 315 mm • For steel, stainless steel and cast iron • Tangential insert with four cutting edges • Screw clamping | B79 |
| FMP12 |  |  WNHU0604 WNHU0806 | 90° | ✓ | | ✓ | | | | <ul style="list-style-type: none"> • Diameter range Ø50 – 315 mm • For steel, stainless steel and cast iron • Tangential insert with four cutting edges • Screw clamping | B81 |
| FMP12 |  |  WNHU0604 | 90° | ✓ | | ✓ | | | | <ul style="list-style-type: none"> • Diameter range Ø50 – 315 mm • For steel, stainless steel and cast iron • Tangential insert with four cutting edges • Screw clamping | B83 |
| FMWX |  |  XEEC1209 | | ✓ | | ✓ | | | | <ul style="list-style-type: none"> • Diameter range Ø50–125 mm • High feed finishing cutters for steel and cast materials • Inserts with four cutting edges • Reserve insert seats for increased safety • The milling body is only equipped with two opposing inserts | B86 |
| FMR01 |  |  RCKT10T3 RCKT1204 RCGX1204 | | ✓ | ✓ | ✓ | ✓ | ✓ | | <ul style="list-style-type: none"> • Diameter range Ø25 – 63 mm • For steel, stainless steel, cast iron, non-ferrous metals and heatresistant alloys • Screw clamping | B88 |

✓ Very suitable ✓ Suitable

A

Turning

B

Milling

C

Drilling



D

Technical Information

E

Index

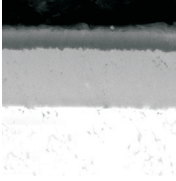
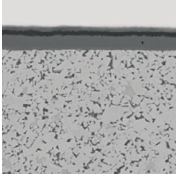
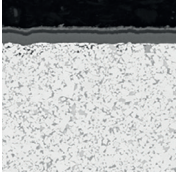
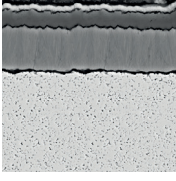
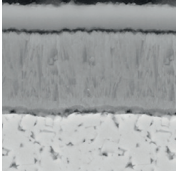
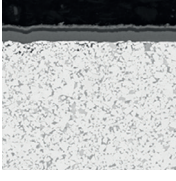
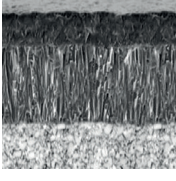
Coated cemented carbide CVD

| Grade | ISO | Micro structure | Grade description |
|---------------|------------------------|---|--|
| YBC302 | P20 - P35 |  | CVD coated P20-P35 carbide grade for medium operation to roughing of steel at higher cutting speed. Optimal performance of wear resistance and toughness for a wide application field. |
| YBC301 | P20 - P35 |  | CVD coated P20-P35 carbide grade for medium operation to roughing of steel at lower cutting speed. |
| YBC401 | P30 - P50 M30 - M40 |  | CVD coated P30-P50/M30-M40 carbide grade for roughing operation of steel at lower cutting speed and unstable condition. |
| YBM251 | P20 - P30 M15 - M35 |  | CVD coated P20-P30/M15-M35 carbide grade for medium to roughing operation in stainless steel and steel with wide application field. Good wear resistance and capability against plastic deformation at normal cutting speed. |
| YBM253 | M15 - M35 |  | CVD coated M15-M35 carbide grade for medium to roughing operation in stainless steel with wide application field. High wear resistance and capability against plastic deformation at higher cutting speed. |
| YBM351 | P25 - P40 M20 - M40 |  | CVD coated P25-P40/M25-M40 carbide grade for roughing operation in stainless steel and steel. Good wear resistance and edge stability at normal cutting speed. |
| YBD152 | K10 - K25 |  | CVD coated K10-K25 carbide substrate. Optimized for medium to roughing operation of cast iron. Good wear resistance and toughness at higher cutting speed. |
| YBD252 | K20 - K35 |  | CVD coated K20-K35 carbide substrate. Optimized for medium to roughing operation of cast iron and Steel. Good wear resistance and toughness at higher cutting speed. |

A

Turning

B

Milling

C

Drilling

DTechnical
Information**E**

Index

Coated cemented carbide PVD

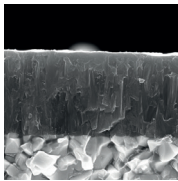
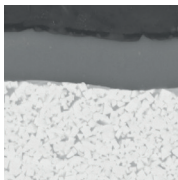
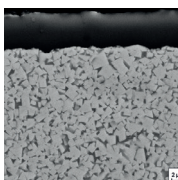
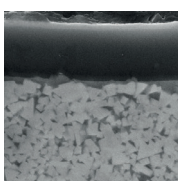
| Grade | ISO | Micro structure | Grade description |
|----------------------------|------------------------|---|--|
| A Turning | YBG101 | N05–N20 |  <p>PVD coated N05–N20 carbide substrate for finishing to semi-finishing in aluminium materials. Coating only on the top face, in combination with the aluminium chip breakers, prevents built-up edges and gives a smooth cut.</p> |
| | | | |
| B Milling | YBG202 | P10 - P30 M10-M25 |  <p>PVD coated P10–P30/M10–M25 carbide substrate for finishing to medium application of stainless steel and steel (milling). Good wear resistance in a wide application field.</p> |
| | | | |
| D Technical Information | YBS203 | S15 – S25 |  <p>Turning and milling grades for processing heat-resistant materials. A special carbon substrate and the latest PVD coating technology enable a very good wear behaviour, high fracture toughness and high thermal stability.</p> |
| | | | |
| YBG302 | P15 - P30 M25 - M40 |  <p>PVD multilayer coated P10–P30/M10–M25 carbide substrate for finishing to medium machining of stainless steel, super alloys and steel (grooving/milling). Optimised coating stability for higher wear resistance and thermal stability in a wide range of applications.</p> | |
| | | | YBG302 |

Coated cemented carbide PVD

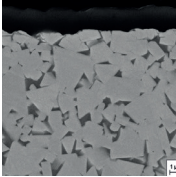
| Grade | ISO | Micro structure | Grade description |
|---------------|-----------|---|---|
| YBS303 | S25 - S35 |  | Milling grade for machining titanium alloys. A tough carbide substrate and the latest PVD coating technology with increased impact resistance and high thermal stability. |

Cermet

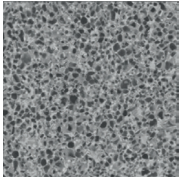
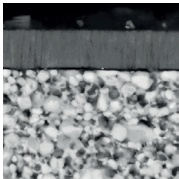
| Grade | ISO | Micro structure | Grade description |
|----------------|-----------|--|--|
| YNG151 | P05 - P15 |  | Uncoated P05-P15 cermet grade for fine finishing operation of steel and stainless steel. Good resistance against plastic deformation for good surface finishing. |
| YNG151C | P05 - P15 |  | PVD coated P05-P15 cermet grade for fine finishing operation of steel and stainless steel. Good wear resistance and capability against plastic deformation for good surface roughness. |

Uncoated cemented carbide

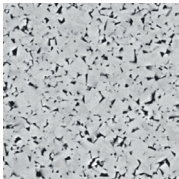
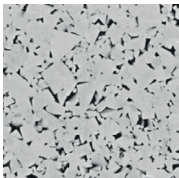
| Grade | ISO | Micro structure | Grade description |
|--------------|------------------------|---|---|
| YD101 | N05 - N25 K05 - K20 |  | Uncoated K05-K20/N05-N20 carbide substrate for fine to medium application in aluminum and other material. |
| YD201 | K10 - K30 N10 - N30 |  | Uncoated K10-K30/N10-N30 carbide substrate for medium application in aluminum and other material. |

A

Turning

B

Milling

C

Drilling

DTechnical
Information**E**

Index

Application fields of grades – indexable milling

| | ISO | HC ¹ (CVD) | HC ¹ (PVD) | HT | HC ² | HW | PCBN/PCD |
|----------|-----|-----------------------|-----------------------|--------|-----------------|-------|----------|
| P | P01 | | YBG102 | | YNG151C | | |
| | P10 | | YBG202 | YNG151 | | | |
| | P20 | YBC301 | YBG205 | | | | |
| | P30 | YBC401 | YBG302 | | | YC305 | |
| | P40 | YBM351 | YB9320 | | | | |
| M | M01 | | YBG102 | | YNG151C | | |
| | M10 | YBM251 | YBG202 | YNG151 | | | |
| | M20 | YBM253 | YBG205 | | | | |
| | M30 | YBM351 | YBG302 | | | YC305 | |
| | M40 | YBC401 | YB9320 | | | | |
| K | K01 | | YBG102 | | | | |
| | K10 | YBD152 | YBG152 | | | | |
| | K20 | YBD252 | YBG202 | | | YD201 | |
| | K30 | | | | | | |
| | K40 | | | | | | |
| N | N01 | | | | | YD051 | |
| | N10 | | YBG101 | | | YD101 | |
| | N20 | | YBG202 | | | | YD201 |
| | N30 | | | | | | |
| S | S01 | | YBG102 | | | | |
| | S10 | | YBG202 | | | | |
| | S20 | | YBG205 | | | | |
| | S30 | | YBS203 | | | | |
| | | | YBS303 | | | | |
| H | H01 | | YBG102 | | | | |
| | H10 | | | | | | |
| | H20 | | | | | | |
| | H30 | | | | | | |

| | |
|----------|-----------------|
| P | Steel |
| M | Stainless steel |
| K | Cast iron |

| | |
|----------|-----------------------|
| N | Non-ferrous metals |
| S | Heat-resistant alloys |
| H | Hardened materials |

| | |
|-----------------|------------------|
| HC ¹ | Coated carbide |
| HT | Uncoated cermet |
| HC ² | Coated carbide |
| HW | Uncoated carbide |