

Face milling

FMA11 Kr: 45°

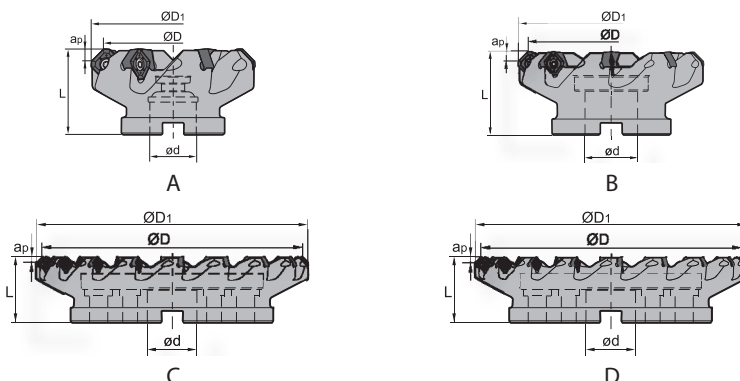
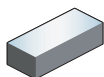

Article	*	Stock	Dimensions [mm]					Teeth	Coupling	kg	Inserts
			ØD	ØD ₁	ød	L	a _{p max}				
FMA11-063-A22-SN12-05C	*	●	63	74.47	22	40	5.5	5	A	0.55	SNEG1205
FMA11-063-A22-SN12-06C	*	●	63	74.47	22	40	5.5	6	A	0.58	
FMA11-080-A27-SN12-06C	*	●	80	91.47	27	50	5.5	6	A	1.14	
FMA11-100-B32-SN12-07		●	100	111.47	32	50	5.5	7	B	1.42	
FMA11-100-B32-SN12-07C	*	○	100	111.47	32	50	5.5	7	B	1.42	
FMA11-100-B32-SN12-10C	*	●	100	111.47	32	50	5.5	10	B	1.42	
FMA11-125-B40-SN12-08		●	125	136.47	40	63	5.5	8	B	2.86	
FMA11-125-B40-SN12-08C	*	○	125	136.47	40	63	5.5	8	B	2.86	
FMA11-125-B40-SN12-12C	*	●	125	136.47	40	63	5.5	12	B	2.86	
FMA11-160-C40-SN12-10		●	160	171.47	40	63	5.5	10	C	4.06	
FMA11-160-C40-SN12-15		●	160	171.47	40	63	5.5	15	C	4.06	
FMA11-200-C60-SN12-14		●	200	212.08	60	63	5.5	14	C	6.89	
FMA11-063-A22-SN15-05C	*	●	63	77.4	22	40	7	5	A	0.56	SNEG1506
FMA11-080-A27-SN15-06C	*	●	80	94.4	27	50	7	6	A	1.06	
FMA11-100-B32-SN15-07		●	100	114.4	32	50	7	7	B	1.47	
FMA11-100-B32-SN15-07C	*	○	100	114.4	32	50	7	7	B	1.47	
FMA11-100-B32-SN15-09C	*	●	100	114.4	32	50	7	9	B	1.47	
FMA11-125-B40-SN15-08		●	125	139.4	40	63	7	8	B	2.7	
FMA11-125-B40-SN15-08C	*	○	125	139.4	40	63	7	8	B	2.7	
FMA11-125-B40-SN15-10C	*	●	125	140.25	40	63	7	10	B	3.1	
FMA11-160-C40-SN15-10		●	160	174.4	40	63	7	10	C	3.92	
FMA11-160-C40-SN15-13		●	160	175.25	40	63	7	13	C	4.14	
FMA11-200-C60-SN15-12		●	200	214.4	60	63	7	12	C	5.46	
FMA11-250-C60-SN15-14		●	250	264.4	60	63	7	14	C	11.26	
FMA11-315-D60-SN15-18		○	315	329.4	60	80	7	18	D	20	
FMA11-125-B40-SN19-07		●	125	142.63	40	63	9	7	B	3	SNEG1907
FMA11-125-B40-SN19-07C	*	●	125	142.63	40	63	9	7	B	3	
FMA11-160-C40-SN19-09		●	160	167.63	40	63	9	9	C	4.25	
FMA11-200-C60-SN19-11		●	200	217.63	60	63	9	11	C	6.18	

● Ex stock ○ On demand

* With internal cooling

System code > B26

Grade selection > B24





Technical info > B527

Cutting data > B230



Article	* Stock	Dimensions [mm]					Teeth	Coupling	kg	Inserts
		ØD	ØD ₁	ød	L	a _{p max}				
FMA11-250-C60-SN19-13	●	250	267.63	60	63	9	13	C	11.55	SNEG1907
FMA11-315-D60-SN19-16	○	315	332.63	60	80	9	16	D	20.9	

● Ex stock ○ On demand



* With internal cooling

Spare parts					
	Insert	SNEG1205	SNEG1506	SNEG1907	
	ØD	63-200	63-315	125-315	
	Screw (insert)	I60M3.5x10 (2.7 Nm)	I60M5x13 (6.7 Nm)	I43M6x16 (9.1 Nm)	
	Wrench (insert)	WT15IS			
	Wrench (insert)		WT20IT	WT25IT	

Milling inserts

-  Ideal machining conditions
-  Normal machining conditions
-  Unfavourable machining conditions

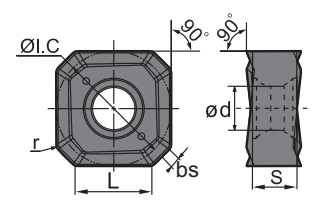
SNEG	L	I.C	S	d
12 05	7.6	12	4.76	4.6
15 06	9.4	15	5.6	5.5
19 07	12.1	19	7	7.2

SN** negative insert				HC ¹ (CVD)					HC ¹ (PVD)					HT	HC ²	HW													
		P	M	K	N	S	H	YBC302	YBC301	YBC401	YBM253	YBM251	YBM351	YBD152	YBD252	YBG101	YBG102	YBG202	YBG212	YBS203	YBG205	YBG920	YBG302	YBS303	YBG252	YNG151	YNG151C	YD101	YD201
	ISO																												
	SNEG1506ANR-E																				●								
	SNEG1205ANR-GM	0.8	1.05	●				●														●							
	SNEG1506ANR-GM	0.9	1.3	●				●														●							

● Ex stock ○ On demand

HC¹ Coated carbide
 HT Uncoated cermet
 HC² Coated cermet
 HW Uncoated carbide

A

Turning

B

Milling

C

Drilling

D

Technical Information

E

Index

- Ideal machining conditions
- ⊗ Normal machining conditions
- ⊗ Unfavourable machining conditions

SNEG	L	I.C	S	d
12 05	7.6	12	4.76	4.6
15 06	9.4	15	5.6	5.5
19 07	12.1	19	7	7.2

Milling inserts

SN** negative insert		HC ¹ (CVD)						HC ¹ (PVD)					HT	HC ²	HW										
	P	●	●	●	●	●	●	●	●	●	●	●	●	●											
	M	●	●	●	●	●	●	●	●	●	●	●	●	●											
	K					●	●	●					●		●										
	N							●						●	●										
	S			●	●			●	●	●	●	●	●												
	H																								
ISO		r	bs	YBC302	YBC301	YBC401	YBM253	YBM251	YBM351	YBD152	YBD252	YBG101	YBG102	YBG202	YBG212	YBS203	YBG205	YB9320	YBG302	YBS303	YBG252	YNG151	YNG151C	YD101	YD201
	SNEG1205ANR-GR	0.8	1.05	●			●									○				○					
	SNEG1506ANR-GR	0.9	1.3	●			●									○					○				
	SNEG1907ANR-GR	1	1.67	●			●			●	●														
	SNEG1506ANR-HGR															○									

● Ex stock ○ On demand

HC¹ Coated carbide
 HT Uncoated cermet
 HC² Coated cermet
 HW Uncoated carbide

- Ideal machining conditions
- ⊗ Normal machining conditions
- ⊗ Unfavourable machining conditions

SNEG	L	I.C	S	d
12 05	12	12	4.76	4.6

Milling inserts

SN** negative insert		HC ¹ (CVD)						HC ¹ (PVD)					HT	HC ²	HW										
	P	●	●	●	●	●	●	●	●	●	●	●	●	●											
	M	●	●	●	●	●	●	●	●	●	●	●	●	●											
	K							●					●		●										
	N							●						●	●										
	S			●	●			●	●	●	●	●	●												
	H																								
ISO		r1	r2	YBC302	YBC301	YBC401	YBM253	YBM251	YBM351	YBD152	YBD252	YBG101	YBG102	YBG202	YBG212	YBS203	YBG205	YB9320	YBG302	YBS303	YBG252	YNG151	YNG151C	YD101	YD201
	SNEG1205ANR-W	0.6	0.8													●									

● Ex stock ○ On demand

HC¹ Coated carbide
 HT Uncoated cermet
 HC² Coated cermet
 HW Uncoated carbide

System code > B26

Grade selection > B24

Technical info > B527

Cutting data > B230

FM A 12 050 – A22 O – N 06 – 04 (L) (C)

1 2 3 4 5 6 7 8 9 10 11

Type	
Code	Description
BM	Profile milling
CM	Chamfer milling
EM	Square shoulder milling
FM	Face milling
HM	Helical milling
SM	Slot milling
TM	T-slot milling
XM	Special

1

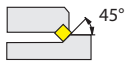
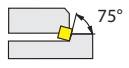
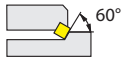
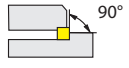
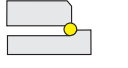
Entering angle	
A	
E	
D	
P	
R	

2

Serial number

3

Nominal diameter [mm]	
Code	Description
025	25
050	50
160	160
315	315
...	

4

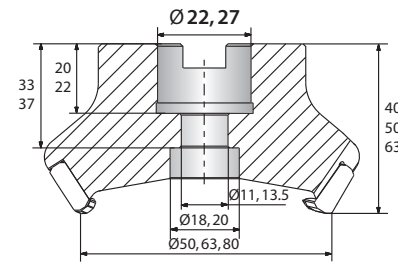
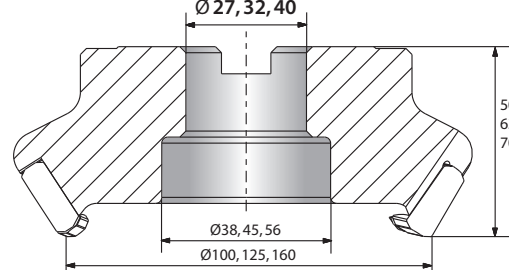
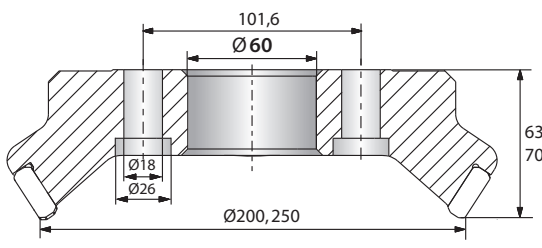
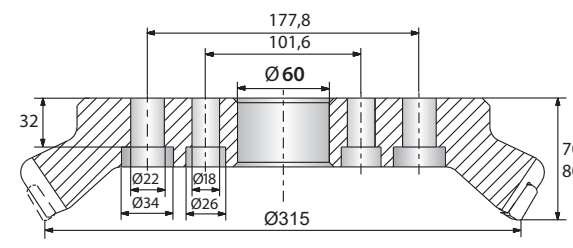
Type and size of tool holders			
Code	Type	Code	Type
A	<p>Nominal diameter $\varnothing 50 - 80$ mm</p> 	B	<p>Nominal diameter $\varnothing 100 - 160$ mm</p> 
C	<p>Nominal diameter $\varnothing 200 - 250$ mm</p> 	D	<p>Nominal diameter $\varnothing 315$ mm</p> 
G	Straight shank	XP	Weldon shank
K	Bore with keyway		

5

With respect to mounting please adhere to the information provided by the tool holder manufacturer.

Insert shape	
A	C
H	L
M	O
P	R
S	T
W	X Special
Z Special	

6

Clearance angle	
B	C
D	E
F	N
P	

7

Cutting edge length l [mm]	
Insert shape	
A	C, M
H, O, P	L
R	S
T	W

8

Number of teeth

9

Cutting direction	
Code	Description
L	Left

10

With inner cooling

11



Tools with B coupling and inner coolant supply require the following spare parts:



Coolant clamp screw



Coolant shower plate



Spare parts (B coupling with inner coolant supply)

		B27	B32	B40	B40
	Ø	80	100	125	160
	Coolant clamp screw	LDB27C	LDB32C	LDB40C	LDB40C
	Coolant shower plate	B27-002-CP	B32-002-CP	B40-002-CP	B40-003-CP

When purchasing tools with inner coolant supply and B coupling these spare parts are included in delivery.

A

Turning

B

Milling

C

Drilling

D

Technical Information

E

Index

S P K N 12 04 ED T21K R – DM

1 2 3 4 5 6 7 8 9 10

A

Turning

B

Milling

C











Drilling







D

Technical Information

E

Index

Insert shape	
A 	C 
H 	L 
M 	O 
P 	R 
S 	T 
W 	X Special
Z Special	















Clearance angle	
B 	C 
D 	E 
F 	N 
P 	









Tolerance class			
			
Code	I.C [mm]	m [mm]	S [mm]
A	±0,025	±0,005	±0,025
C	±0,025	±0,013	±0,025
E	±0,025	±0,025	±0,025
F	±0,013	±0,005	±0,025
G	±0,025	±0,025	±0,130
H	±0,013	±0,013	±0,025
J	±0,05-0,13	±0,005	±0,025
K	±0,05-0,13	±0,013	±0,025
L	±0,05-0,13	±0,025	±0,025
M	±0,05-0,13	±0,08-0,18	±0,130
N	±0,05-0,13	±0,08-0,18	±0,025
U	±0,08-0,25	±0,13-0,38	±0,130

1

2

3

Fastening features (metric)	
Insert shape	
A 	B 
C 	F 
G 	H 
J 	M 
N 	Q 
R 	T 
U 	W 
X Special	

Cutting edge length l [mm]	
Insert shape	
	
A	C, M
	
H, O, P	L
	
R	S
	
T	W

4

5

Insert thickness S [mm]			
Code	S	Code	S
00	0,79	05	5,56
T0	0,99	T5	5,95
01	1,59	06	6,35
T1	1,98	T6	6,75
02	2,38	07	7,94
T2	2,58	09	9,52
03	3,18	T9	9,72
T3	3,97	11	11,11
04	4,76	12	12,70
T4	4,96		

6

Angle			
Code	Kr	Code	an
A	45°	A	3°
D	60°	B	5°
E	75°	C	7°
F	85°	D	15°
P	90°	E	20°
Z	Special	F	25°
		G	30°
		N	0°
		P	11°
		Z	Special

7

Chamfer							
Code	Type	Code	Angle	Code	Width [mm]	Code	Position
F		0	5°	0	0,10	K	
E		1	10°	1	0,15	P	
T		2	15°	2	0,20	W	
S		3	20°	3	0,25	-	
		4	25°	4	0,30		
		5	30°	5	0,35		
				6	0,40		
				7	0,45		

8

Cutting direction	
Code	Description
R	Right
L	Left
N	Right and left

9

Chip breaker overview
(on page B20)

10

A

Turning

B

Milling

C

Drilling

D

Technical Information

E

Index

Guide for recommended cutting data – indexable milling

Indexable milling – group 1 (FMA07/11/12, FMD02, EMP09/13)

Material group	Composition / structure / heat treatment	Brinell hardness HB	Machining group	Starting values for cutting speed v_c (m/min)								
				HC (CVD)								
				YBC302		YBC401		YBD152		YBD252		
				a_p / D		a_p / D		a_p / D		a_p / D		
1/1 3/4		1/5		1/1 3/4		1/5		1/1 3/4		1/5		
P Unalloyed steel	ca. 0,15 % C	annealed	125	1	260	300	225	260				
	ca. 0,45 % C	annealed	190	2	225	255	195	225				
	ca. 0,45 % C	tempered	250	3	210	240	180	210				
	ca. 0,75 % C	annealed	270	4	185	210	160	185				
	ca. 0,75 % C	tempered	300	5	170	195	150	170				
P Low-alloyed steel		annealed	180	6	225	255	195	225				
		tempered	275	7	185	210	160	185				
		tempered	300	8	170	195	150	170				
		tempered	350	9	145	165	125	145				
P High-alloyed steel and high-alloyed tool steel		annealed	200	10	130	150	115	130				
		hardened and tempered	325	11	95	105	80	95				
M Stainless steel	ferritic/martensitic	annealed	200	12								
	martensitic	tempered	240	13								
	austenitic	quench hardened	180	14								
	austenitic-ferritic		230	15								
K Grey cast iron	perlite/ferritic		180	16				370	430	320	370	
	perlite (martensitic)		260	17				220	255	190	220	
K Cast iron with spheroidal graphite	ferritic		160	18				255	295	220	255	
	perlite		250	19				170	200	145	170	
K Malleable cast iron	ferritic		130	20				305	355	265	305	
	perlite		230	21				205	240	175	205	
N Aluminium wrought alloys	cannot be hardened		60	22								
	hardenable	hardened	100	23								
	≤ 12 % Si, cannot be hardened		75	24								
	≤ 12 % Si, hardenable	hardened	90	25								
N Cast aluminium alloys	> 12 % Si, cannot be hardened		130	26								
	machining steel, PB > 1%		110	27								
	CuZn, CuSnZn		90	28								
S Copper and copper alloys (bronze/brass)	CuSn, Pb-free copper, electrolytic copper		100	29								
	Heat-resistant alloys	Fe-based alloys	annealed	200	30							
		hardened	280	31								
	Ni or Co base	annealed	250	32								
hardened		350	33									
Titanium alloys	cast	320	34									
	pure titanium		R _m 400	35								
H Hardened steel	α and β alloys	hardened	R _m 1050	36								
	hardened and tempered		55 HRC	37								
H Hard cast iron	hardened and tempered		60 HRC	38								
	cast		400	39								
H Hardened cast iron	hardened and tempered		55 HRC	40								
	Thermoplasts			41								
X Non-metallic materials	Thermosetting plastics			42								
	Plastic, glass-fibre reinforced GFRP			43								
	Plastic, carbon fibre reinforced CFRP			44								
	Graphite			45								
	Wood			46								

Note: The given cutting values are guide values, which were determined under ideal conditions.

The values have to be adapted in individual cases.

Feed rate recommendations on page B248

For examples of material for cutting tool groups view page D22.

Recommend feed rate

Indexable milling – group1 (FMA07/11/12, FMD02, EMP09/13)

5	Material group	Feed rate per cutting edge [mm]																			
		EMP09			EMP13			EMP13			FMA07			FMA07			FMA11				
		LNKT12			ANGX11			ANGX15			ONHU06			ONHU08			SNEG12				
		Application																			
		F	M	R	F	M	R	F	M	R	F	M	R	F	M	R	F	M	R		
P	Unalloyed steel		0,25	0,50		0,23			0,25		0,19	0,23		0,19	0,23		0,20	0,23			
	Low-alloyed steel		0,23	0,47		0,22			0,23		0,17	0,22		0,17	0,22		0,19	0,21			
	High-alloyed steel and high-alloyed tool steel		0,22	0,44		0,20			0,22		0,16	0,20		0,16	0,20		0,18	0,20			
M	Stainless steel		0,18	0,35													0,14	0,16			
K	Grey cast iron		0,28	0,55		0,26			0,28		0,20	0,26		0,20	0,26		0,22	0,25			
	Cast iron with spheroidal graphite		0,25	0,50		0,23			0,25		0,19	0,23		0,19	0,23		0,20	0,23			
	Malleable cast iron		0,25	0,50		0,23			0,25		0,19	0,23		0,19	0,23		0,20	0,23			
N	Aluminium wrought alloys					0,20			0,21												
	Aluminium-Gusslegierungen					0,20			0,21												
	Copper and copper alloys(bronze/brass)					0,18			0,19												
S	Heat-resistant alloys																				
	Titanium alloys																				
H	Hardened steel																				
	Hard cast iron																				
	Hardened cast iron																				
X	Non-metallic materials																				

A

Turning

B

Milling

C

Drilling

D

Technical Information

E

Index

1. Select the appropriate product family/cutting data group.
2. Select the used grade.
3. Determine the immersion.
4. Select the used material and read the cutting speed.
5. Please have a look at the detached feed rate recommendations.
6. Select the used tool, the machining mode and the used material.



Indexable milling – group 1 (FMA07/11/12, FMD02, FMP12, EMP09/13)

	Material group	Composition / structure / heat treatment		Brinell hardness HB	Machining group	Starting values for cutting speed v_c [m/min]								
						HC (CVD)								
						YBC302		YBC401		YBD152		YBD252		
						a_e / D		a_e / D		a_e / D		a_e / D		
1/1 3/4		1/5		1/1 3/4		1/5		1/1 3/4		1/5				
A Turning	P Unalloyed steel	approx. 0,15 % C	annealed	125	1	260	300	225	260					
		approx. 0,45 % C	annealed	190	2	225	255	195	225					
		approx. 0,45 % C	tempered	250	3	210	240	180	210					
		approx. 0,75 % C	annealed	270	4	185	210	160	185					
		approx. 0,75 % C	tempered	300	5	170	195	150	170					
	B Milling	P Low-alloyed steel		annealed	180	6	225	255	195	225				
				tempered	275	7	185	210	160	185				
				tempered	300	8	170	195	150	170				
			tempered	350	9	145	165	125	145					
C Drilling	P High-alloyed steel and high-alloyed tool steel		annealed	200	10	130	150	115	130					
			hardened and tempered	325	11	95	105	80	95					
M Milling	M Stainless steel	ferritic/martensitic	annealed	200	12									
			martensitic	tempered	240	13								
			austenitic	quench hardened	180	14								
			austenitic-ferritic		230	15								
K Milling	K Grey cast iron	perlitic/ferritic		180	16					370	430	320	370	
			perlitic (martensitic)		260	17				220	255	190	220	
	K Cast iron with spheroidal graphite	ferritic		160	18					255	295	220	255	
			perlitic		250	19				170	200	145	170	
	K Malleable cast iron	ferritic		130	20					305	355	265	305	
			perlitic		230	21				205	240	175	205	
N Milling	N Aluminium wrought alloys	cannot be hardened		60	22									
			hardenable	hardened	100	23								
	N Cast aluminium alloys	$\leq 12\% \text{ Si}$, cannot be hardened			75	24								
			$\leq 12\% \text{ Si}$, hardenable	hardened	90	25								
			$> 12\% \text{ Si}$, cannot be hardened			130	26							
	N Copper and copper alloys (bronze/brass)	machining steel, PB > 1%			110	27								
		CuZn, CuSnZn			90	28								
CuSn, Pb-free copper, electrolytic copper			100	29										
S Milling	S Heat-resistant alloys	Fe-based alloys	annealed	200	30									
				hardened	280	31								
		Ni or Co base	annealed	250	32									
				hardened	350	33								
		cast	320	34										
S Titanium alloys	pure titanium		$R_m 400$	35										
	α and β alloys	hardened	$R_m 1050$	36										
H Milling	H Hardened steel		hardened and tempered	55 HRC	37									
			hardened and tempered	60 HRC	38									
	H Hard cast iron		cast	400	39									
	H Hardened cast iron		hardened and tempered	55 HRC	40									
X Milling	X Non-metallic materials	Thermoplasts			41									
		Thermosetting plastics			42									
		Plastic, glass-fibre reinforced GFRP			43									
		Plastic, carbon fibre reinforced CFRP			44									
		Graphite			45									
		Wood			46									

Note: The given cutting values are guide values, which were determined under ideal conditions.
 The values have to be adapted in individual cases.
 Feed rate recommendations on page B254.
 For examples of material for cutting tool groups view page D11.

A
Turning
B
Milling
C
Drilling
D
Technical Information
E
Index

Starting values for cutting speed v_c [m/min]															
HC (CVD)		HC (PVD)										HW			
YBM253		YBG102		YB9320		YBG205		YBG252		YBG302		YD101		YD201	
a_e / D		a_e / D		a_e / D		a_e / D		a_e / D		a_e / D		a_e / D		a_e / D	
1/1 3/4	1/5	1/1 3/4	1/5	1/1 3/4	1/5	1/1 3/4	1/5	1/1 3/4	1/5	1/1 3/4	1/5	1/1 3/4	1/5	1/1 3/4	1/5
260	300	270	315	245	285	235	275	230	265	225	260				
225	255	230	270	210	245	200	235	200	230	195	225				
210	240	220	255	200	230	190	220	185	215	180	210				
185	210	190	225	175	200	165	195	165	190	160	185				
170	195	180	205	160	190	155	180	150	175	150	170				
225	255	230	270	210	245	200	235	200	230	195	225				
185	210	190	225	175	200	165	195	165	190	160	185				
170	195	180	205	160	190	155	180	150	175	150	170				
145	165	150	175	135	160	130	155	130	150	125	145				
130	150	135	160	125	145	120	140	115	135	115	130				
95	105	95	115	90	100	85	100	85	95	80	95				
130	150	135	160	125	145	120	140	115	135	115	130				
110	130	115	135	105	120	100	120	100	115	95	110				
140	160	145	170	130	155	125	150	125	145	120	140				
110	130	115	135	105	120	100	120	100	115	95	110				
		300	345	270	315	260	300	255	295	250	290				
		180	205	160	190	155	180	150	175	150	170				
		205	240	185	215	180	210	175	200	170	195				
		135	160	125	145	120	140	115	135	115	130				
		245	285	225	260	215	250	210	240	205	235				
		165	190	150	175	145	165	140	160	135	160				
												1505	1735	1450	1670
												1225	1420	1180	1370
												540	620	515	600
												435	505	420	485
												220	255	215	250
												170	195	160	190
												210	245	205	235
												385	445	370	430

HC Coated carbide
 HT Uncoated carbide, main component (TiC) o. (TiN), cermet
 HC₁ Coated cermet
 HW Uncoated carbide, main component (WC)

A
Turning
B
Milling
C
Drilling
D
Technical Information
E
Index



Recommended feed rate

Indexable milling – group1 (FMA07/11/12, FMD02, EMP09/13)

Material group	Feed rate per cutting edge [mm]																			
	EMP09			EMP09			EMP13			EMP13			FMA07			FMA07				
	LNKT08/12			LNKT16			ANGX11			ANGX15			ONHU06			ONHU08				
	Application																			
	F	M	R	F	M	R	F	M	R	F	M	R	F	M	R	F	M	R		
P Unalloyed steel		0,25	0,50		0,28	0,55		0,23			0,25		0,19	0,23		0,19	0,23			
	Low-alloyed steel		0,23	0,47		0,26	0,51		0,22			0,23		0,17	0,22		0,17	0,22		
	High-alloyed steel and high-alloyed tool steel		0,22	0,44		0,24	0,48		0,20			0,22		0,16	0,20		0,16	0,20		
M Stainless steel		0,18	0,35		0,19	0,39		0,16			0,18									
K Grey cast iron		0,28	0,55		0,30	0,61		0,26			0,28		0,20	0,26		0,20	0,26			
	Cast iron with spheroidal graphite		0,25	0,50		0,28	0,55		0,23			0,25		0,19	0,23		0,19	0,23		
	Malleable cast iron		0,25	0,50		0,28	0,55		0,23			0,25		0,19	0,23		0,19	0,23		
N Aluminum wrought alloys								0,20			0,21									
	Aluminum cast alloys								0,20			0,21								
	Copper and copper alloys (bronze/brass)								0,18			0,19								
S Heat-resistant alloys																				
	Titanium alloys																			
H Hardened steel																				
	Hard cast iron																			
	Hardened cast iron																			
X Non-metallic materials																				













Note: The given cutting values are guide values, which were determined under ideal conditions.
The values have to be adapted in individual cases.

Indexable milling – group1 (FMA07/11/12, FMD02, EMP09/13)

Material group	Feed rate per cutting edge [mm]																		
	FMP12																		
	WNHU08																		
	Application																		
	F	M	R																
P Unalloyed steel		0,25																	
	Low-alloyed steel		0,23																
	High-alloyed steel and high-alloyed tool steel		0,22																
M Stainless steel		0,18																	
K Grey cast iron		0,28																	
	Cast iron with spheroidal graphite		0,25																
	Malleable cast iron		0,25																
N Aluminium wrought alloys																			
	Aluminum cast alloys																		
	Copper and copper alloys (bronze/brass)																		
S Heat-resistant alloys																			
	Titanium alloys																		
H Hardened steel																			
	Hard cast iron																		
	Hardened cast iron																		
X Non-metallic materials																			

Note: The given cutting values are guide values, which were determined under ideal conditions.
The values have to be adapted in individual cases.

Face milling

Series	Milling body	Inserts	Kr	Application						Features	Page	
				P	M	K	N	S	H			
FMA07		 ONHU0604 ONHU08T5	45°	✓		✓				✓	<ul style="list-style-type: none"> • Diameter range Ø25 – 50 mm • For steel and cast iron • Inserts with 16 cutting edges 	B48
FMA07		 ONHU0604 ONHU08T5	45°	✓		✓				✓	<ul style="list-style-type: none"> • Diameter range Ø40 – 315 mm • For steel and cast iron • Inserts with 16 cutting edges 	B50
FMA11		 SNEG1205 SNEG1506 SNEG1907	45°	✓	✓	✓			✓		<ul style="list-style-type: none"> • Diameter range Ø63 – 315 mm • For steel, stainless steel and cast iron • Inserts with eight cutting edges • Double sided, thicker inserts for high stability and deeper cutting depths • Wiper geometry for good surface quality • Normal and fine pitch 	B52
FMA12		 ON*U0604** ONHU08T6	45°	✓	✓	✓			✓		<ul style="list-style-type: none"> • Diameter range Ø63 – 315 mm • For steel, stainless steel and cast iron • Inserts with 16 cutting edges 	B55
FMD02		 PNEG1105	67°	✓	✓	✓					<ul style="list-style-type: none"> • Diameter range Ø50 – 315 mm • For steel, stainless steel and cast iron • Inserts with ten cutting edges • Wedge clamping or screw clamping • Normal and fine pitch 	B57
FMD02		 PNEG1105	67°			✓					<ul style="list-style-type: none"> • Diameter range Ø50 – 315 mm • For steel, stainless steel and cast iron • Inserts with ten cutting edges • Wedge clamping or screw clamping • Normal and fine pitch 	B60

✓ Very suitable ✓ Suitable

A

Turning

B

Milling

C

Drilling



D

Technical Information

E

Index

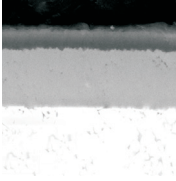
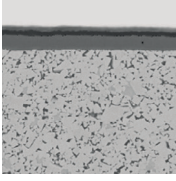
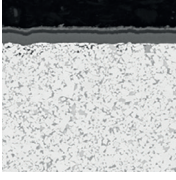
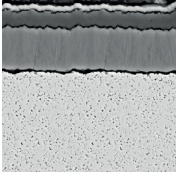
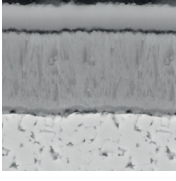
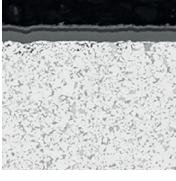
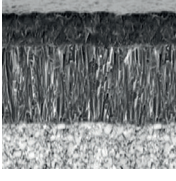
Coated cemented carbide CVD

Grade	ISO	Micro structure	Grade description
YBC302	P20 - P35		CVD coated P20-P35 carbide grade for medium operation to roughing of steel at higher cutting speed. Optimal performance of wear resistance and toughness for a wide application field.
YBC301	P20 - P35		CVD coated P20-P35 carbide grade for medium operation to roughing of steel at lower cutting speed.
YBC401	P30 - P50 M30 - M40		CVD coated P30-P50/M30-M40 carbide grade for roughing operation of steel at lower cutting speed and unstable condition.
YBM251	P20 - P30 M15 - M35		CVD coated P20-P30/M15-M35 carbide grade for medium to roughing operation in stainless steel and steel with wide application field. Good wear resistance and capability against plastic deformation at normal cutting speed.
YBM253	M15 - M35		CVD coated M15-M35 carbide grade for medium to roughing operation in stainless steel with wide application field. High wear resistance and capability against plastic deformation at higher cutting speed.
YBM351	P25 - P40 M20 - M40		CVD coated P25-P40/M25-M40 carbide grade for roughing operation in stainless steel and steel. Good wear resistance and edge stability at normal cutting speed.
YBD152	K10 - K25		CVD coated K10-K25 carbide substrate. Optimized for medium to roughing operation of cast iron. Good wear resistance and toughness at higher cutting speed.
YBD252	K20 - K35		CVD coated K20-K35 carbide substrate. Optimized for medium to roughing operation of cast iron and Steel. Good wear resistance and toughness at higher cutting speed.

A

Turning

B

Milling

C

Drilling

DTechnical
Information**E**

Index

Coated cemented carbide PVD

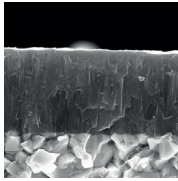
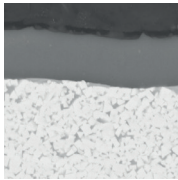
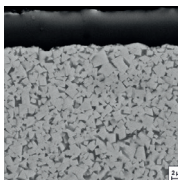
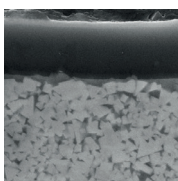
Grade	ISO	Micro structure	Grade description
A Turning	YBG101	N05–N20	 <p>PVD coated N05–N20 carbide substrate for finishing to semi-finishing in aluminium materials. Coating only on the top face, in combination with the aluminium chip breakers, prevents built-up edges and gives a smooth cut.</p>
B Milling	YBG202	P10 - P30 M10-M25	 <p>PVD coated P10–P30/M10–M25 carbide substrate for finishing to medium application of stainless steel and steel (milling). Good wear resistance in a wide application field.</p>
D Technical Information	YBS203	S15 – S25	 <p>Turning and milling grades for processing heat-resistant materials. A special carbon substrate and the latest PVD coating technology enable a very good wear behaviour, high fracture toughness and high thermal stability.</p>
YBG302	P15 - P30 M25 - M40	 <p>PVD multilayer coated P10–P30/M10–M25 carbide substrate for finishing to medium machining of stainless steel, super alloys and steel (grooving/milling). Optimised coating stability for higher wear resistance and thermal stability in a wide range of applications.</p>	
			YBG302

Coated cemented carbide PVD

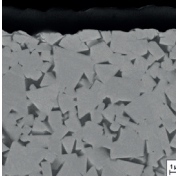
Grade	ISO	Micro structure	Grade description
YBS303	S25 - S35		Milling grade for machining titanium alloys. A tough carbide substrate and the latest PVD coating technology with increased impact resistance and high thermal stability.

Cermet

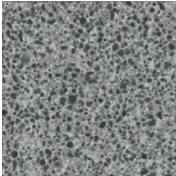
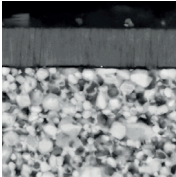
Grade	ISO	Micro structure	Grade description
YNG151	P05 - P15		Uncoated P05-P15 cermet grade for fine finishing operation of steel and stainless steel. Good resistance against plastic deformation for good surface finishing.
YNG151C	P05 - P15		PVD coated P05-P15 cermet grade for fine finishing operation of steel and stainless steel. Good wear resistance and capability against plastic deformation for good surface roughness.

Uncoated cemented carbide

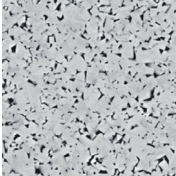
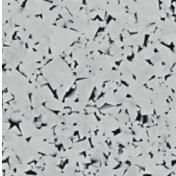
Grade	ISO	Micro structure	Grade description
YD101	N05 - N25 K05 - K20		Uncoated K05-K20/N05-N20 carbide substrate for fine to medium application in aluminum and other material.
YD201	K10 - K30 N10 - N30		Uncoated K10-K30/N10-N30 carbide substrate for medium application in aluminum and other material.

A

Turning

B

Milling

C

Drilling

DTechnical
Information**E**

Index

Application fields of grades – indexable milling

	ISO	HC ¹ (CVD)	HC ¹ (PVD)	HT	HC ²	HW	PCBN/PCD
P	P01		YBG102		YNG151C		
	P10		YBG202	YNG151			
	P20	YBC301	YBG205				
	P30	YBC401	YBG302			YC305	
	P40	YBM351	YB9320				
M	M01		YBG102		YNG151C		
	M10	YBM251	YBG202	YNG151			
	M20	YBM253	YBG205				
	M30	YBM351	YBG302			YC305	
	M40	YBC401	YB9320				
K	K01		YBG102				
	K10	YBD152	YBG152				
	K20	YBD252	YBG202			YD201	
	K30						
	K40						
N	N01					YD051	
	N10		YBG101			YD101	
	N20		YBG202				YD201
	N30						
S	S01		YBG102				
	S10		YBG202				
	S20		YBG205				
	S30		YBS203				
			YBS303				
H	H01		YBG102				
	H10						
	H20						
	H30						

P	Steel
M	Stainless steel
K	Cast iron

N	Non-ferrous metals
S	Heat-resistant alloys
H	Hardened materials

HC ¹	Coated carbide
HT	Uncoated cermet
HC ²	Coated carbide
HW	Uncoated carbide