

Face milling

FMA04 Kr: 45°

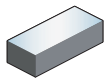

Wedge

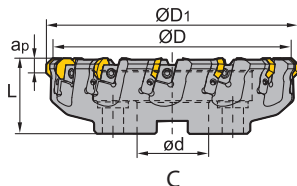

C

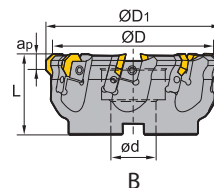

B

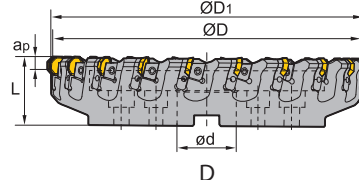









D

Article	*	Stock		Dimensions [mm]					Teeth	Coupling	kg	Inserts 
		R	L	ØD	ØD ₁	ød	L	a _{p max}				
FMA04-125-B40-OF07-08	○			125	136	40	63	5	8	B	3.9	OFKR0704
FMA04-160-B40-OF07-10	○			160	171	40	63	5	10	B	5.9	
FMA04-200-C60-OF07-12	○			200	211	60	63	5	12	C	7.6	
FMA04-250-C60-OF07-16	○			250	261	60	63	5	16	C	13.3	
FMA04-315-D60-OF07-20	○	○		315	321	60	63	5	20	D	20.3	

● Ex stock ○ On demand

* With internal cooling

Spare parts

	Insert ØD	OFKR0704 125 - 315
	Adjustable screw	LOM5×15.1
	Cassette (left)	LOF07L
	Cassette (right)	LOF07R
	Screw (wedge)	DM8×21X (10.2 Nm)
	Wedge (left)	W02L
	Wedge (right)	W02R
	Wrench (locator)	WT20T
	Wrench (wedge)	WH40T

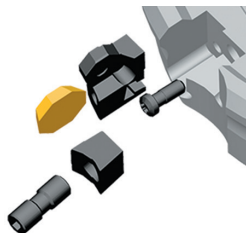

System code > B26

Grade selection > B24

Technical info > B527

Cutting data > B230

- Ideal machining conditions
- Normal machining conditions
- Unfavourable machining conditions

OFKR	L	I.C	S
07 04	7.45	17.94	4.76

Milling inserts

OF** milling insert			HC ¹ (CVD)						HC ¹ (PVD)						HT	HC ²	HW							
		P	●●●●●●●●	●●●●●●●●	●●●●●●●●	●●●●●●●●	●●●●●●●●	●●●●●●●●	●●●●●●●●	●●●●●●●●	●●●●●●●●	●●●●●●●●	●●●●●●●●	●●●●●●●●	●●●●●●●●	●●●●●●●●	●●●●●●●●							
		M	●●●●●●●●	●●●●●●●●	●●●●●●●●	●●●●●●●●	●●●●●●●●	●●●●●●●●	●●●●●●●●	●●●●●●●●	●●●●●●●●	●●●●●●●●	●●●●●●●●	●●●●●●●●	●●●●●●●●	●●●●●●●●	●●●●●●●●	●●●●●●●●						
		K	●●●●●●●●	●●●●●●●●	●●●●●●●●	●●●●●●●●	●●●●●●●●	●●●●●●●●	●●●●●●●●	●●●●●●●●	●●●●●●●●	●●●●●●●●	●●●●●●●●	●●●●●●●●	●●●●●●●●	●●●●●●●●	●●●●●●●●	●●●●●●●●						
		N	●●●●●●●●	●●●●●●●●	●●●●●●●●	●●●●●●●●	●●●●●●●●	●●●●●●●●	●●●●●●●●	●●●●●●●●	●●●●●●●●	●●●●●●●●	●●●●●●●●	●●●●●●●●	●●●●●●●●	●●●●●●●●	●●●●●●●●	●●●●●●●●						
		S	●●●●●●●●	●●●●●●●●	●●●●●●●●	●●●●●●●●	●●●●●●●●	●●●●●●●●	●●●●●●●●	●●●●●●●●	●●●●●●●●	●●●●●●●●	●●●●●●●●	●●●●●●●●	●●●●●●●●	●●●●●●●●	●●●●●●●●	●●●●●●●●						
		H	●●●●●●●●	●●●●●●●●	●●●●●●●●	●●●●●●●●	●●●●●●●●	●●●●●●●●	●●●●●●●●	●●●●●●●●	●●●●●●●●	●●●●●●●●	●●●●●●●●	●●●●●●●●	●●●●●●●●	●●●●●●●●	●●●●●●●●	●●●●●●●●						
ISO		R	YBC302	YBC301	YBC401	YBM253	YBM251	YBM351	YBD152	YBD252	YBG101	YBG102	YBG202	YBG212	YBS203	YBG205	YB9320	YBG302	YBS303	YBG252	YNG151	YNG151C	YD101	YD201
	OFKR0704-DF	0.8				○						○												
	OFKR0704-DM	0.8	○	○		○	○		○			○						○						
	OFKR0704W-DM	0.8	○					○							○									
	OFKR0704-LH	0.8																					○	

● Ex stock ○ On demand

HC¹ Coated carbide
 HT Uncoated cermet
 HC² Coated cermet
 HW Uncoated carbide

A

Turning

B

Milling

C

Drilling

D

Technical Information

E

Index

System code > B26

Grade selection > B24

Technical info > B527

Cutting data > B230





FM A 12 050 – A22 O – N 06 – 04 (L) (C)

1 2 3 4 5 6 7 8 9 10 11

Type	
Code	Description
BM	Profile milling
CM	Chamfer milling
EM	Square shoulder milling
FM	Face milling
HM	Helical milling
SM	Slot milling
TM	T-slot milling
XM	Special

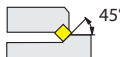
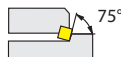
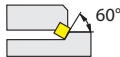
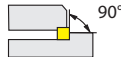
1

Entering angle	
A	
E	
D	
P	
R	

2

Serial number

3





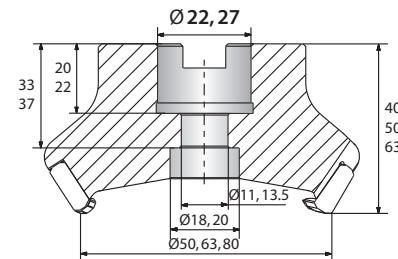
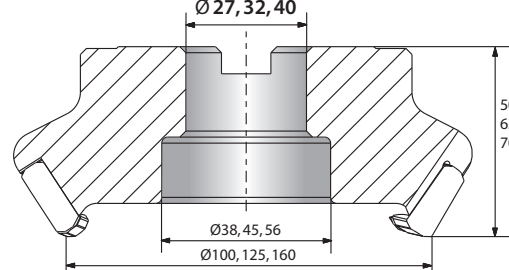
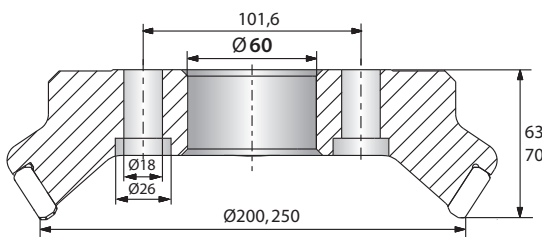
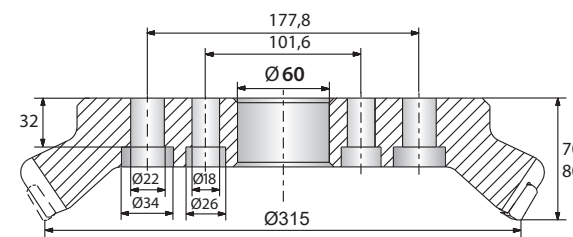





Nominal diameter [mm]	
Code	Description
025	25
050	50
160	160
315	315
...	

4







Type and size of tool holders			
Code	Type	Code	Type
A	<p>Nominal diameter $\varnothing 50 - 80$ mm</p> 	B	<p>Nominal diameter $\varnothing 100 - 160$ mm</p> 
C	<p>Nominal diameter $\varnothing 200 - 250$ mm</p> 	D	<p>Nominal diameter $\varnothing 315$ mm</p> 
G	Straight shank	XP	Weldon shank
K	Bore with keyway		

5









With respect to mounting please adhere to the information provided by the tool holder manufacturer.

Insert shape	
A 	C 
H 	L 
M 	O 
P 	R 
S 	T 
W 	X Special
Z Special	

6

Clearance angle	
B 	C 
D 	E 
F 	N 
P 	

7

Cutting edge length l [mm]	
Insert shape	
	
A	C, M
	
H, O, P	L
	
R	S
	
T	W

8

Number of teeth

9

Cutting direction	
Code	Description
L	Left

10

With inner cooling

11



Tools with B coupling and inner coolant supply require the following spare parts:





Coolant clamp screw



Coolant shower plate



Spare parts (B coupling with inner coolant supply)

		B27	B32	B40	B40
	Ø	80	100	125	160
	Coolant clamp screw	LDB27C	LDB32C	LDB40C	LDB40C
	Coolant shower plate	B27-002-CP	B32-002-CP	B40-002-CP	B40-003-CP

When purchasing tools with inner coolant supply and B coupling these spare parts are included in delivery.

A

Turning

B

Milling

C

Drilling

D

Technical Information

E

Index

S P K N 12 04 ED T21K R – DM

1

2

3

4

5

6

7

8

9

10

A

Turning

B

Milling

C











Drilling







D

Technical Information

E

Index

Insert shape	
A 	C 
H 	L 
M 	O 
P 	R 
S 	T 
W 	X Special
Z Special	















Clearance angle	
B 	C 
D 	E 
F 	N 
P 	









Tolerance class			
			
Code	I.C [mm]	m [mm]	S [mm]
A	±0,025	±0,005	±0,025
C	±0,025	±0,013	±0,025
E	±0,025	±0,025	±0,025
F	±0,013	±0,005	±0,025
G	±0,025	±0,025	±0,130
H	±0,013	±0,013	±0,025
J	±0,05-0,13	±0,005	±0,025
K	±0,05-0,13	±0,013	±0,025
L	±0,05-0,13	±0,025	±0,025
M	±0,05-0,13	±0,08-0,18	±0,130
N	±0,05-0,13	±0,08-0,18	±0,025
U	±0,08-0,25	±0,13-0,38	±0,130

1

2

3

Fastening features (metric)	
Insert shape	
A 	B 
C 	F 
G 	H 
J 	M 
N 	Q 
R 	T 
U 	W 
X Special	

Cutting edge length l [mm]	
Insert shape	
	
A	C, M
	
H, O, P	L
	
R	S
	
T	W

4

5

Insert thickness S [mm]			
Code	S	Code	S
00	0,79	05	5,56
T0	0,99	T5	5,95
01	1,59	06	6,35
T1	1,98	T6	6,75
02	2,38	07	7,94
T2	2,58	09	9,52
03	3,18	T9	9,72
T3	3,97	11	11,11
04	4,76	12	12,70
T4	4,96		

6

Angle			
Code	Kr	Code	an
A	45°	A	3°
D	60°	B	5°
E	75°	C	7°
F	85°	D	15°
P	90°	E	20°
Z	Special	F	25°
		G	30°
		N	0°
		P	11°
		Z	Special

7

Chamfer							
Code	Type	Code	Angle	Code	Width [mm]	Code	Position
F		0	5°	0	0,10	K	
E		1	10°	1	0,15	P	
T		2	15°	2	0,20	W	
S		3	20°	3	0,25	-	
		4	25°	4	0,30		
		5	30°	5	0,35		
				6	0,40		
				7	0,45		

8

Cutting direction	
Code	Description
R	Right
L	Left
N	Right and left

9

Chip breaker overview
(on page B20)

10

A

Turning

B

Milling

C

Drilling

D

Technical Information

E

Index

Guide for recommended cutting data – indexable milling

Indexable milling – group 1 (FMA07/11/12, FMD02, EMP09/13)

Material group	Composition / structure / heat treatment	Brinell hardness HB	Machining group	Starting values for cutting speed v_c (m/min)								
				HC (CVD)								
				YBC302		YBC401		YBD152		YBD252		
				a_p / D		a_p / D		a_p / D		a_p / D		
				1/1 3/4	1/5	1/1 3/4	1/5	1/1 3/4	1/5			
P Unalloyed steel	ca. 0,15 % C	annealed	125	1	260	300	225	260				
	ca. 0,45 % C	annealed	190	2	225	255	195	225				
	ca. 0,45 % C	tempered	250	3	210	240	180	210				
	ca. 0,75 % C	annealed	270	4	185	210	160	185				
	ca. 0,75 % C	tempered	300	5	170	195	150	170				
P Low-alloyed steel		annealed	180	6	225	255	195	225				
		tempered	275	7	185	210	160	185				
		tempered	300	8	170	195	150	170				
		tempered	350	9	145	165	125	145				
P High-alloyed steel and high-alloyed tool steel		annealed	200	10	130	150	115	130				
		hardened and tempered	325	11	95	105	80	95				
M Stainless steel	ferritic/martensitic	annealed	200	12								
	martensitic	tempered	240	13								
	austenitic	quench hardened	180	14								
	austenitic-ferritic		230	15								
K Grey cast iron	perlite/ferritic		180	16				370	430	320	370	
	perlite (martensitic)		260	17				220	255	190	220	
K Cast iron with spheroidal graphite	ferritic		160	18				255	295	220	255	
	perlite		250	19				170	200	145	170	
K Malleable cast iron	ferritic		130	20				305	355	265	305	
	perlite		230	21				205	240	175	205	
N Aluminium wrought alloys	cannot be hardened		60	22								
	hardenable	hardened	100	23								
	≤ 12 % Si, cannot be hardened		75	24								
	≤ 12 % Si, hardenable	hardened	90	25								
N Cast aluminium alloys	> 12 % Si, cannot be hardened		130	26								
	machining steel, PB > 1%		110	27								
	CuZn, CuSnZn		90	28								
S Copper and copper alloys (bronze/brass)	CuSn, Pb-free copper, electrolytic copper		100	29								
	Heat-resistant alloys	Fe-based alloys	annealed	200	30							
		hardened	280	31								
	Ni or Co base	annealed	250	32								
hardened		350	33									
Titanium alloys	cast	320	34									
	pure titanium		R _m 400	35								
H Hardened steel	α and β alloys	hardened	R _m 1050	36								
	hardened and tempered		55 HRC	37								
H Hard cast iron	hardened and tempered		60 HRC	38								
	cast		400	39								
X Non-metallic materials	hardened and tempered		55 HRC	40								
	Thermoplasts			41								
	Thermosetting plastics			42								
	Plastic, glass-fibre reinforced GFRP			43								
	Plastic, carbon fibre reinforced CFRP			44								
	Graphite			45								
Wood			46									

Note: The given cutting values are guide values, which were determined under ideal conditions. The values have to be adapted in individual cases. Feed rate recommendations on page B248. For examples of material for cutting tool groups view page D22.

Recommend feed rate

Indexable milling – group1 (FMA07/11/12, FMD02, EMP09/13)

5	Material group	Feed rate per cutting edge [mm]																			
		EMP09			EMP13			EMP13			FMA07			FMA07			FMA11				
		LNKT12			ANGX11			ANGX15			ONHU06			ONHU08			SNEG12				
		Application																			
		F	M	R	F	M	R	F	M	R	F	M	R	F	M	R	F	M	R		
P	Unalloyed steel		0,25	0,50		0,23			0,25		0,19	0,23		0,19	0,23		0,20	0,23			
	Low-alloyed steel		0,23	0,47		0,22			0,23		0,17	0,22		0,17	0,22		0,19	0,21			
	High-alloyed steel and high-alloyed tool steel		0,22	0,44		0,20			0,22		0,16	0,20		0,16	0,20		0,18	0,20			
M	Stainless steel		0,18	0,35													0,14	0,16			
K	Grey cast iron		0,28	0,55		0,26			0,28		0,20	0,26		0,20	0,26		0,22	0,25			
	Cast iron with spheroidal graphite		0,25	0,50		0,23			0,25		0,19	0,23		0,19	0,23		0,20	0,23			
	Malleable cast iron		0,25	0,50		0,23			0,25		0,19	0,23		0,19	0,23		0,20	0,23			
N	Aluminium wrought alloys					0,20			0,21												
	Aluminium-Gusslegierungen					0,20			0,21												
	Copper and copper alloys(bronze/brass)					0,18			0,19												
S	Heat-resistant alloys																				
	Titanium alloys																				
H	Hardened steel																				
	Hard cast iron																				
	Hardened cast iron																				
X	Non-metallic materials																				

1. Select the appropriate product family/cutting data group.
2. Select the used grade.
3. Determine the immersion.
4. Select the used material and read the cutting speed.
5. Please have a look at the detached feed rate recommendations.
6. Select the used tool, the machining mode and the used material.

A

Turning

B

Milling

C

Drilling

D

Technical Information

E

Index

Indexable milling – group 2 (FMA01/02/03/04, FME01/02, FMP01/02, EMP01/02/03/04)

	Material group	Composition / structure / heat treatment		Brinell hardness HB	Machining group	Starting values for cutting speed v_c [m/min]							
						HC (CVD)							
						YBC302		YBC401		YBD152		YBD252	
						a_e / D		a_e / D		a_e / D		a_e / D	
						1/1 3/4	1/5	1/1 3/4	1/5	1/1 3/4	1/5	1/1 3/4	1/5
P	Unalloyed steel	approx. 0,15 % C	annealed	125	1	245	285	210	245				
		approx. 0,45 % C	annealed	190	2	210	245	180	210				
		approx. 0,45 % C	tempered	250	3	200	230	170	200				
		approx. 0,75 % C	annealed	270	4	175	200	150	175				
		approx. 0,75 % C	tempered	300	5	160	190	140	160				
	Low-alloyed steel		annealed	180	6	210	245	180	210				
			tempered	275	7	175	200	150	175				
			tempered	300	8	160	190	140	160				
		tempered	350	9	135	160	120	135					
High-alloyed steel and high-alloyed tool steel		annealed	200	10	125	145	105	125					
		hardened and tempered	325	11	90	100	75	90					
M	Stainless steel	ferritic/martensitic	annealed	200	12								
			martensitic	tempered	240	13							
			austenitic	quench hardened	180	14							
			austenitic-ferritic		230	15							
K	Grey cast iron	perlitic/ferritic		180	16					315	365	270	315
			perlitic (martensitic)		260	17				185	215	160	190
	Cast iron with spheroidal graphite	ferritic		160	18					215	250	185	215
			perlitic		250	19				145	170	125	145
	Malleable cast iron	ferritic		130	20					260	300	225	260
			perlitic		230	21				175	205	150	175
N	Aluminium wrought alloys	cannot be hardened		60	22								
			hardenable	hardened	100	23							
	Cast aluminium alloys	$\leq 12\% \text{ Si}$, cannot be hardened			75	24							
			$\leq 12\% \text{ Si}$, hardenable	hardened	90	25							
			$> 12\% \text{ Si}$, cannot be hardened			130	26						
	Copper and copper alloys (bronze/brass)	machining steel, PB > 1%			110	27							
		CuZn, CuSnZn			90	28							
		CuSn, Pb-free copper, electrolytic copper			100	29							
S	Heat-resistant alloys	Fe-based alloys	annealed	200	30								
				hardened	280	31							
		Ni or Co base	annealed	250	32								
				hardened	350	33							
		cast	320	34									
Titanium alloys	pure titanium		R_m 400	35									
	α and β alloys	hardened	R_m 1050	36									
H	Hardened steel		hardened and tempered	55 HRC	37								
			hardened and tempered	60 HRC	38								
	Hard cast iron		cast	400	39								
	Hardened cast iron		hardened and tempered	55 HRC	40								
X	Non-metallic materials	Thermoplasts			41								
		Thermosetting plastics			42								
		Plastic, glass-fibre reinforced GFRP			43								
		Plastic, carbon fibre reinforced CFRP			44								
		Graphite			45								
		Wood			46								

Note: The given cutting values are guide values, which were determined under ideal conditions.
 The values have to be adapted in individual cases.
 Feed rate recommendations on page B254.
 For examples of material for cutting tool groups view page D11.

Starting values for cutting speed v_c [m/min]																					
HC (CVD)				HC (PVD)												HW				HT	
YBM253		YBG101		YBG102		YBG152		YB9320		YBG205		YBG252		YBG302		YD101		YD201		YNG151	
a_e / D		a_e / D		a_e / D		a_e / D		a_e / D		a_e / D		a_e / D		a_e / D		a_e / D		a_e / D		a_e / D	
1/1 3/4	1/5	1/1 3/4	1/5	1/1 3/4	1/5	1/1 3/4	1/5	1/1 3/4	1/5	1/1 3/4	1/5	1/1 3/4	1/5	1/1 3/4	1/5	1/1 3/4	1/5	1/1 3/4	1/5	1/1 3/4	1/5
245	285			255	295	240	280	230	265	220	255	215	250	210	245					270	315
210	245			220	255	205	240	200	230	190	220	185	215	180	210					235	270
200	230			205	240	195	225	185	215	180	205	175	200	170	200					220	255
175	200			180	210	170	200	165	190	155	180	155	175	150	175					195	220
160	190			170	195	160	185	150	175	145	170	140	165	140	160					180	210
210	245			220	255	205	240	200	230	190	220	185	215	180	210					235	270
175	200			180	210	170	200	165	190	155	180	155	175	150	175					195	220
160	190			170	195	160	185	150	175	145	170	140	165	140	160					180	210
135	160			145	165	135	155	130	150	125	145	120	140	120	135					150	180
125	145			130	150	120	140	115	135	110	130	110	125	105	125					140	160
90	100			90	105	85	100	85	95	80	90	80	90	75	90					100	110
125	145			130	150	120	140	115	135	110	130	110	125	105	125					135	160
105	120			110	125	105	120	100	115	95	110	95	105	90	105					115	135
130	155			140	160	130	150	125	145	120	140	115	135	115	130					145	170
105	120			110	125	105	120	100	115	95	110	95	105	90	105					115	135
				285	330	265	305	255	295	245	285	240	280	235	275						
				170	195	160	185	150	175	145	170	140	165	140	160						
				195	225	180	210	175	200	165	195	165	190	160	185						
				130	150	120	140	115	135	110	130	110	125	105	125						
				230	270	220	255	210	240	200	230	195	225	190	225						
				155	180	145	170	140	160	135	155	130	150	130	150						
		1505	1735													1205	1390	1040	1200		
		1225	1420													980	1140	850	980		
		540	620													435	500	375	435		
		435	505													350	405	300	350		
		220	255													180	205	155	180		
		170	195													140	160	120	140		
		210	245													170	200	150	170		
		385	445													310	360	265	310		
				75	85	70	80	65	75	65	75	65	75	60	70						
				50	55	50	55	45	50	45	50	45	50	40	45						
				60	70	55	65	55	65	50	55	50	55	50	55						
				35	40	35	40	30	35	30	35	30	35	30	35						
				45	50	45	50	40	45	40	45	40	45	40	45						
				75	85	70	80	65	75	65	75	65	75	60	70						
				75	85	70	80	65	75	65	75	65	75	60	70						

HC Coated carbide
 HT Uncoated carbide, main component (TiC) o. (TiN), cermet
 HC₁ Coated cermet
 HW Uncoated carbide, main component (WC)

A

Turning

B

Milling

C

Drilling

D

Technical Information

E

Index

Indexable milling – group 2 (FMA01/02/03/04, FME01/02, FMP01/02, EMP01/02/03/04)

	Material group	Composition / structure / heat treatment		Brinell hardness HB	Machining group	Starting values for cutting speed vc [m/min]				
						HC ₁				
						YNG151C				
						a _e / D				
						1/1 3/4	1/5			
A Turning	P Unalloyed steel	approx. 0,15 % C	annealed	125	1	285	335			
		approx. 0,45 % C	annealed	190	2	250	285			
		approx. 0,45 % C	tempered	250	3	235	270			
		approx. 0,75 % C	annealed	270	4	205	235			
		approx. 0,75 % C	tempered	300	5	190	225			
	B Milling	Low-alloyed steel		annealed	180	6	250	285		
				tempered	275	7	205	235		
				tempered	300	8	190	225		
				tempered	350	9	160	190		
		High-alloyed steel and high-alloyed tool steel	annealed	200	10	150	170			
		hardened and tempered	325	11	105	120				
C Drilling	M Stainless steel	ferritic/martensitic	annealed	200	12	145	170			
		martensitic	tempered	240	13	120	145			
		austenitic	quench hardened	180	14	155	180			
		austenitic-ferritic		230	15	120	145			
D Technical Information	K Cast iron with spheroidal graphite	Grey cast iron	perlitic/ferritic	180	16					
			perlitic (martensitic)	260	17					
	Malleable cast iron	ferritic		160	18					
		perlitic		250	19					
	E Index	N Aluminium wrought alloys	cannot be hardened		60	22				
			hardenable	hardened	100	23				
Cast aluminium alloys		≤ 12% Si, cannot be hardened		75	24					
		≤ 12% Si, hardenable	hardened	90	25					
		> 12% Si, cannot be hardened		130	26					
Copper and copper alloys (bronze/brass)		machining steel, PB> 1%		110	27					
	CuZn, CuSnZn		90	28						
		CuSn, Pb-free copper, electrolytic copper		100	29					
F Index	S Heat-resistant alloys	Fe-based alloys	annealed	200	30					
			hardened	280	31					
		Ni or Co bass	annealed	250	32					
			hardened	350	33					
			cast	320	34					
	Titanium alloys	pure titanium		R _m 400	35					
	α and β alloys	hardened	R _m 1050	36						
H Hardened steel	Hardened steel		hardened and tempered	55 HRC	37					
			hardened and tempered	60 HRC	38					
	Hard cast iron		cast	400	39					
	Hardened cast iron		hardened and tempered	55 HRC	40					
X Non-metallic materials	Non-metallic materials	Thermoplasts			41					
		Thermosetting plastics			42					
		Plastic, glass-fibre reinforced GFRP			43					
		Plastic, carbon fibre reinforced CFRP			44					
		Graphite			45					
		Wood			46					

Note: The given cutting values are guide values, which were determined under ideal conditions.
 The values have to be adapted in individual cases.
 Feed rate recommendations on page B254.
 For examples of material for cutting tool groups view page D11.

Recommended feed rate

Indexable milling – group 2 (FMA01/02/03/04, FME01/02, FMP01/02, EMP01/02/03/04)

Material group		Feed rate per cutting edge [mm]																	
		FMA01 FMA02			FMA03			FMA03			FMA04			FMA04			FMA04		
		SEET12			SEKN12			SEKN15			OFKT05			OFKR07			ODHT06		
		Application																	
		F	M	R	F	M	R	F	M	R	F	M	R	F	M	R	F	M	R
P	Unalloyed steel	0,15	0,20	0,25		0,18			0,20		0,20	0,25		0,20	0,25		0,20	0,25	
	Low-alloyed steel	0,14	0,19	0,23		0,17			0,19		0,19	0,23		0,19	0,23		0,19	0,23	
	High-alloyed steel and high-alloyed tool steel	0,13	0,18	0,22		0,16			0,18		0,18	0,22		0,18	0,22		0,18	0,22	
M	Stainless steel	0,11	0,14	0,18		0,13			0,14		0,14	0,18		0,14	0,18		0,14	0,18	
K	Grey cast iron	0,17	0,22	0,28		0,20			0,22		0,22	0,28		0,22	0,28		0,22	0,28	
	Cast iron with spheroidal graphite	0,15	0,20	0,25		0,18			0,20		0,20	0,25		0,20	0,25		0,20	0,25	
	Malleable cast iron	0,15	0,20	0,25		0,18			0,20		0,20	0,25		0,20	0,25		0,20	0,25	
N	Aluminium wrought alloys	0,13	0,17	0,21							0,17	0,21		0,17	0,21		0,17	0,21	
	Aluminum cast alloys	0,13	0,17	0,21							0,17	0,21		0,17	0,21		0,17	0,21	
	Copper and copper alloys (bronze/brass)	0,11	0,15	0,19							0,15	0,19		0,15	0,19		0,15	0,19	
S	Heat-resistant alloys	0,11	0,14	0,18							0,14	0,18		0,14	0,18		0,14	0,18	
	Titanium alloys	0,11	0,14	0,18							0,14	0,18		0,14	0,18		0,14	0,18	
H	Hardened steel																		
	Hard cast iron																		
	Hardened cast iron																		
X	Non-metallic materials																		

Note: The given cutting values are guide values, which were determined under ideal conditions. The values have to be adapted in individual cases.

Indexable milling – group 3 (FMR01/02/03/04) Face milling

Material group		Feed rate per cutting edge [mm]																	
		FMR01			FMR01			FMR02			FMR02			FMR02			FMR03		
		RCKT10			RC*12			RC*12			RCKT16			RCKT20			RDKW07		
		Application																	
		F	M	R	F	M	R	F	M	R	F	M	R	F	M	R	F	M	R
P	Unalloyed steel		0,20	0,25		0,20	0,25		0,20	0,25		0,23	0,29		0,26	0,33		0,17	
	Low-alloyed steel		0,19	0,23		0,19	0,23		0,19	0,23		0,21	0,27		0,25	0,31		0,16	
	High-alloyed steel and high-alloyed tool steel		0,18	0,22		0,18	0,22		0,18	0,22		0,20	0,25		0,23	0,29		0,15	
M	Stainless steel		0,14	0,18		0,14	0,18		0,14	0,18		0,16	0,20		0,19	0,23		0,12	
K	Grey cast iron		0,22	0,28		0,22	0,28		0,22	0,28		0,25	0,32		0,29	0,36		0,19	
	Cast iron with spheroidal graphite		0,20	0,25		0,20	0,25		0,20	0,25		0,23	0,29		0,26	0,33		0,17	
	Malleable cast iron		0,20	0,25		0,20	0,25		0,20	0,25		0,23	0,29		0,26	0,33		0,17	
N	Aluminium wrought alloys					0,17	0,21		0,17	0,21									
	Aluminum cast alloys					0,17	0,21		0,17	0,21									
	Copper and copper alloys (bronze/brass)					0,15	0,19		0,15	0,19									
S	Heat-resistant alloys																		
	Titanium alloys																		
H	Hardened steel																		
	Hard cast iron																		
	Hardened cast iron																		
X	Non-metallic materials																		

Note: The given cutting values are guide values, which were determined under ideal conditions. The values have to be adapted in individual cases.

Feed rate per cutting edge [mm]																										
FME02			FME03			FME03			FMP01			FMP02			EMP01 EMP02			EMP01 EMP02			EMP03 EMP04					
SPK*12			SPK*12			SPK*15			TPKN22			SEET12			APKT11			APKT16			APKT11					
Application																										
F	M	R	F	M	R	F	M	R	F	M	R	F	M	R	F	M	R	F	M	R	F	M	R	F	M	R
	0,20			0,19			0,20			0,20		0,15	0,20	0,25	0,10	0,15	0,20	0,12	0,17	0,23	0,10	0,20	0,25			
	0,19			0,17			0,19			0,19		0,14	0,19	0,23	0,09	0,14	0,19	0,11	0,16	0,21	0,09	0,19	0,23			
	0,18			0,16			0,18			0,18		0,13	0,18	0,22	0,09	0,13	0,18	0,10	0,15	0,20	0,09	0,18	0,22			
	0,14			0,13			0,14			0,14		0,11	0,14	0,18	0,07	0,11	0,14	0,08	0,12	0,16	0,07	0,14	0,18			
	0,22			0,20			0,22			0,22		0,17	0,22	0,28	0,11	0,17	0,22	0,13	0,19	0,25	0,11	0,22	0,28			
	0,20			0,19			0,20			0,20		0,15	0,20	0,25	0,10	0,15	0,20	0,12	0,17	0,23	0,10	0,20	0,25			
	0,20			0,19			0,20			0,20		0,15	0,20	0,25	0,10	0,15	0,20	0,12	0,17	0,23	0,10	0,20	0,25			
												0,13	0,17	0,21	0,09	0,13	0,17	0,10	0,15	0,20	0,09	0,17	0,21			
												0,13	0,17	0,21	0,09	0,13	0,17	0,10	0,15	0,20	0,09	0,17	0,21			
												0,11	0,15	0,19	0,08	0,11	0,15	0,09	0,13	0,18	0,08	0,15	0,19			

F Finishing
M Medium machining
R Roughing









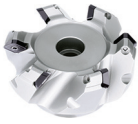

Feed rate per cutting edge [mm]														
FMR03			FMR03			FMR04			FMR04			FMR04		
RDKW08			RD*10			RD*12			RDKW16			RDKW20		
Application														
F	M	R	F	M	R	F	M	R	F	M	R	F	M	R
	0,17			0,20		0,15	0,20	0,25	0,17	0,23	0,29	0,2	0,26	0,33
	0,16			0,19		0,14	0,19	0,23	0,16	0,21	0,27	0,19	0,25	0,31
	0,15			0,18		0,13	0,18	0,22	0,15	0,20	0,25	0,18	0,23	0,29
	0,12			0,14		0,11	0,14	0,18	0,12	0,16	0,20	0,14	0,19	0,23
	0,19			0,22		0,17	0,22	0,28	0,19	0,25	0,32	0,22	0,29	0,36
	0,17			0,20		0,15	0,20	0,25	0,17	0,23	0,29	0,20	0,26	0,33
	0,17			0,20		0,15	0,20	0,25	0,17	0,23	0,29	0,20	0,26	0,33
				0,17		0,13	0,17	0,21						
				0,17		0,13	0,17	0,21						
				0,15		0,11	0,15	0,19						

F Finishing
M Medium machining
R Roughing

A
Turning
B
Milling
C
Drilling
D
Technical Information
E
Index

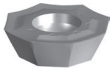

Face milling

Series	Milling body	Inserts	Kr	Application						Features	Page
				P	M	K	N	S	H		
FMA01		 SEET12T3 SEET18T6	45°	✓	✓	✓	✓	✓		<ul style="list-style-type: none"> • Diameter range Ø50 – 315 mm • For steel, stainless steel, cast iron, non-ferrous metals and heatresistant alloys • Milling cutter with positive, soft cutting geometry • Wiper inserts for good surface quality 	B33
FMA02		 SEET12T3	45°	✓	✓	✓	✓	✓		<ul style="list-style-type: none"> • Diameter range Ø50 – 125 mm • For steel, stainless steel, cast iron, non-ferrous metals and heatresistant alloys • Milling cutter with positive, soft cutting geometry • Wide pitch 	B36
FMA03		 SEEN1203 SEKN1203 SEKR1203 SEKN1504 SEKR1504	45°	✓	✓	✓	✓			<ul style="list-style-type: none"> • Diameter range Ø80 – 315 mm • For steel, stainless steel and cast iron • Milling cutter with positive, soft cutting geometry • Wedge clamping 	B39
FMA04		 OFKT05T3	45°	✓	✓	✓	✓			<ul style="list-style-type: none"> • Diameter range Ø50 – 160 mm • For steel, stainless steel, cast iron and non-ferrous metals • Inserts with eight cutting edges • Screw clamping 	B42
FMA04		 OFKR0704	45°	✓	✓	✓	✓			<ul style="list-style-type: none"> • Diameter range Ø125 – 315 mm • For steel, stainless steel, cast iron and non-ferrous metals • Inserts with eight cutting edges • Wedge clamping 	B44
FMA04		 OD*T0605**	45°	✓	✓	✓	✓			<ul style="list-style-type: none"> • Diameter range Ø50 – 160 mm • For steel, stainless steel, cast iron and non-ferrous metals • Inserts with eight cutting edges • Screw clamping 	B46

✓ Very suitable ✓ Suitable

A
Turning



B
Milling

C
Drilling

D
Technical Information

E
Index

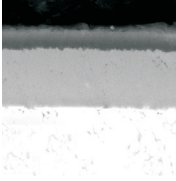
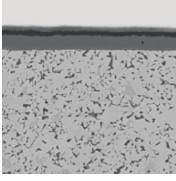
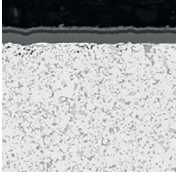
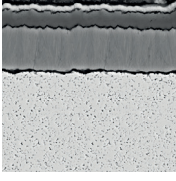
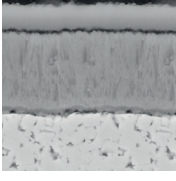
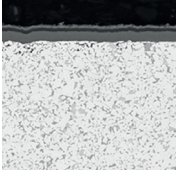
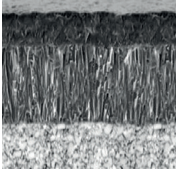
Coated cemented carbide CVD

Grade	ISO	Micro structure	Grade description
YBC302	P20 - P35		CVD coated P20-P35 carbide grade for medium operation to roughing of steel at higher cutting speed. Optimal performance of wear resistance and toughness for a wide application field.
YBC301	P20 - P35		CVD coated P20-P35 carbide grade for medium operation to roughing of steel at lower cutting speed.
YBC401	P30 - P50 M30 - M40		CVD coated P30-P50/M30-M40 carbide grade for roughing operation of steel at lower cutting speed and unstable condition.
YBM251	P20 - P30 M15 - M35		CVD coated P20-P30/M15-M35 carbide grade for medium to roughing operation in stainless steel and steel with wide application field. Good wear resistance and capability against plastic deformation at normal cutting speed.
YBM253	M15 - M35		CVD coated M15-M35 carbide grade for medium to roughing operation in stainless steel with wide application field. High wear resistance and capability against plastic deformation at higher cutting speed.
YBM351	P25 - P40 M20 - M40		CVD coated P25-P40/M25-M40 carbide grade for roughing operation in stainless steel and steel. Good wear resistance and edge stability at normal cutting speed.
YBD152	K10 - K25		CVD coated K10-K25 carbide substrate. Optimized for medium to roughing operation of cast iron. Good wear resistance and toughness at higher cutting speed.
YBD252	K20 - K35		CVD coated K20-K35 carbide substrate. Optimized for medium to roughing operation of cast iron and Steel. Good wear resistance and toughness at higher cutting speed.

A

Turning

B

Milling

C

Drilling

DTechnical
Information**E**

Index

Coated cemented carbide PVD

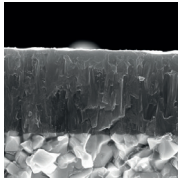
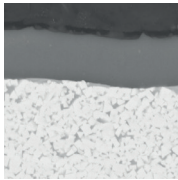
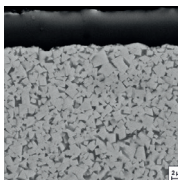
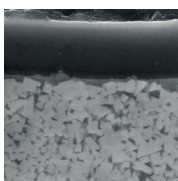
Grade	ISO	Micro structure	Grade description
A Turning	YBG101	N05–N20	 <p>PVD coated N05–N20 carbide substrate for finishing to semi-finishing in aluminium materials. Coating only on the top face, in combination with the aluminium chip breakers, prevents built-up edges and gives a smooth cut.</p>
B Milling	YBG202	P10 - P30 M10-M25	 <p>PVD coated P10–P30/M10–M25 carbide substrate for finishing to medium application of stainless steel and steel (milling). Good wear resistance in a wide application field.</p>
D Technical Information	YBS203	S15 – S25	 <p>Turning and milling grades for processing heat-resistant materials. A special carbon substrate and the latest PVD coating technology enable a very good wear behaviour, high fracture toughness and high thermal stability.</p>
YBG302	P15 - P30 M25 - M40	 <p>PVD multilayer coated P10–P30/M10–M25 carbide substrate for finishing to medium machining of stainless steel, super alloys and steel (grooving/milling). Optimised coating stability for higher wear resistance and thermal stability in a wide range of applications.</p>	
			YBG302

Coated cemented carbide PVD

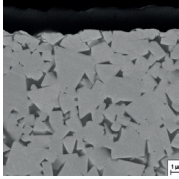
Grade	ISO	Micro structure	Grade description
YBS303	S25 - S35		Milling grade for machining titanium alloys. A tough carbide substrate and the latest PVD coating technology with increased impact resistance and high thermal stability.

Cermet

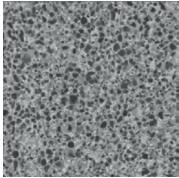
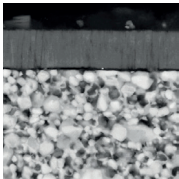
Grade	ISO	Micro structure	Grade description
YNG151	P05 - P15		Uncoated P05-P15 cermet grade for fine finishing operation of steel and stainless steel. Good resistance against plastic deformation for good surface finishing.
YNG151C	P05 - P15		PVD coated P05-P15 cermet grade for fine finishing operation of steel and stainless steel. Good wear resistance and capability against plastic deformation for good surface roughness.

Uncoated cemented carbide

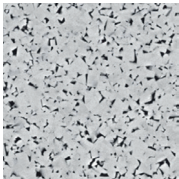
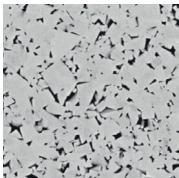
Grade	ISO	Micro structure	Grade description
YD101	N05 - N25 K05 - K20		Uncoated K05-K20/N05-N20 carbide substrate for fine to medium application in aluminum and other material.
YD201	K10 - K30 N10 - N30		Uncoated K10-K30/N10-N30 carbide substrate for medium application in aluminum and other material.

A

Turning

B

Milling

C

Drilling

DTechnical
Information**E**

Index

Application fields of grades – indexable milling

	ISO	HC ¹ (CVD)	HC ¹ (PVD)	HT	HC ²	HW	PCBN/PCD
P	P01		YBG102		YNG151C		
	P10		YBG202	YNG151			
	P20	YBC301	YBG205				
	P30	YBC401	YBG302			YC305	
	P40	YBM351	YB9320				
M	M01		YBG102		YNG151C		
	M10	YBM251	YBG202	YNG151			
	M20	YBM253	YBG205				
	M30	YBM351	YBG302			YC305	
	M40	YBC401	YB9320				
K	K01		YBG102				
	K10	YBD152	YBG152				
	K20	YBD252	YBG202			YD201	
	K30						
	K40						
N	N01					YD051	
	N10		YBG101			YD101	
	N20		YBG202				YD201
	N30						
S	S01		YBG102				
	S10		YBG202				
	S20		YBG205				
	S30		YBS203				
			YBS303				
H	H01		YBG102				
	H10						
	H20						
	H30						

P	Steel
M	Stainless steel
K	Cast iron

N	Non-ferrous metals
S	Heat-resistant alloys
H	Hardened materials

HC ¹	Coated carbide
HT	Uncoated cermet
HC ²	Coated carbide
HW	Uncoated carbide