

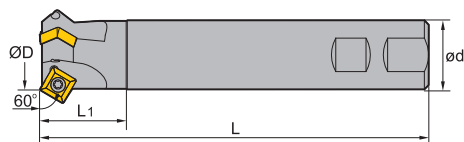

Chamfer milling

CMD01 Kr: 60° 





Weldon shank

Article	*	Stock	Dimensions [mm]				Teeth	kg	Inserts
			ØD	ød	L ₁	L			
CMD01-012-XP20-SP12-01		●	12	20	40	100	1	0.2	 SPMT1204
CMD01-025-XP25-SP12-02		●	25	25	40	120	2	0.6	
CMD01-036-XP32-SP12-03		●	36	32	40	180	3	1	

● Ex stock ○ On demand

* With internal cooling

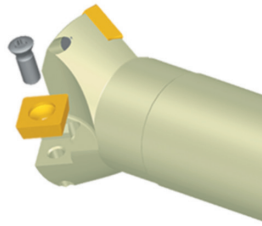
Spare parts

	Insert ØD	SPMT1204 12-36	
	Screw (insert)	M3M5×11 (6.7Nm)	
	Wrench (insert)	WT20IS	

A

Turning

B

Milling

C

Drilling

D

Technical
Information

E

Index

A

Turning

B

Milling

C

Drilling

D

Technical Information

E

Index

- Ideal machining conditions
- Normal machining conditions
- Unfavourable machining conditions

SPMT	L	I.C	S	d
12 04	12.7	12.7	4.76	5.5

Milling inserts

SP** milling insert		HC ¹ (CVD)						HC ¹ (PVD)						HT	HC ²	HW								
	P	●	●	●	●	●	●	●	●	●	●	●	●	●	●									
	M	●	●	●	●	●	●	●	●	●	●	●	●	●	●									
	K							●								●								
	N							●								●								
	S		●	●				●	●	●	●	●	●											
	H																							
	ISO	r	YBC302	YBC301	YBC401	YBM253	YBM251	YBM351	YBD152	YBD252	YBG101	YBG102	YBG202	YBG212	YBS203	YBG205	YB9320	YBG302	YBS303	YBG252	YNG151	YNG151C	YD101	YD201
	SPMT120408-HT-1	0.8												○										
	SPMT120408	0.8	○	●	○		●	○										○						

● Ex stock ○ On demand

HC¹ Coated carbide
 HT Uncoated cermet
 HC² Coated cermet
 HW Uncoated carbide

System code > B26

Grade selection > B24

Technical info > B527



Cutting data > B230

FM A 12 050 – A22 O – N 06 – 04 (L) (C)

1 2 3 4 5 6 7 8 9 10 11

Type	
Code	Description
BM	Profile milling
CM	Chamfer milling
EM	Square shoulder milling
FM	Face milling
HM	Helical milling
SM	Slot milling
TM	T-slot milling
XM	Special

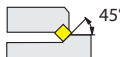
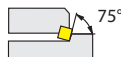
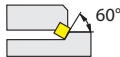
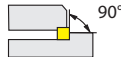
1

Entering angle	
A	
E	
D	
P	
R	

2

Serial number

3





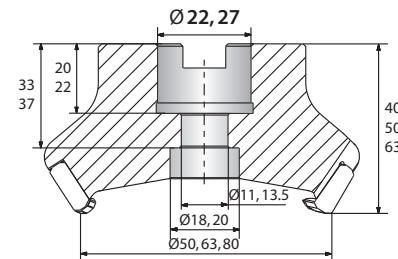
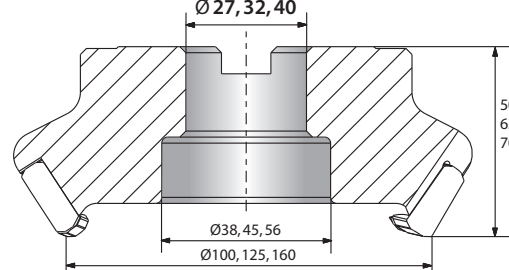
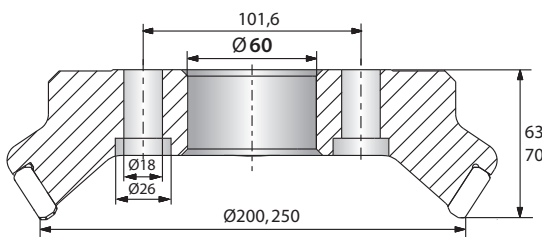
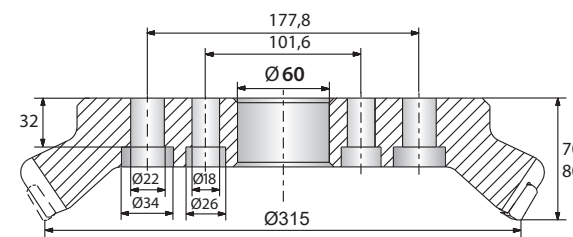





Nominal diameter [mm]	
Code	Description
025	25
050	50
160	160
315	315
...	

4







Type and size of tool holders			
Code	Type	Code	Type
A	<p>Nominal diameter $\varnothing 50 - 80$ mm</p> 	B	<p>Nominal diameter $\varnothing 100 - 160$ mm</p> 
C	<p>Nominal diameter $\varnothing 200 - 250$ mm</p> 	D	<p>Nominal diameter $\varnothing 315$ mm</p> 
G	Straight shank	XP	Weldon shank
K	Bore with keyway		

5









With respect to mounting please adhere to the information provided by the tool holder manufacturer.

Insert shape	
A 	C 
H 	L 
M 	O 
P 	R 
S 	T 
W 	X Special
Z Special	

6

Clearance angle	
B 	C 
D 	E 
F 	N 
P 	

7

Cutting edge length l [mm]	
Insert shape	
	
A	C, M
	
H, O, P	L
	
R	S
	
T	W

8

Number of teeth

9

Cutting direction	
Code	Description
L	Left

10

With inner cooling

11



Tools with B coupling and inner coolant supply require the following spare parts:





Coolant clamp screw



Coolant shower plate



Spare parts (B coupling with inner coolant supply)

		B27	B32	B40	B40
	Ø	80	100	125	160
	Coolant clamp screw	LDB27C	LDB32C	LDB40C	LDB40C
	Coolant shower plate	B27-002-CP	B32-002-CP	B40-002-CP	B40-003-CP

When purchasing tools with inner coolant supply and B coupling these spare parts are included in delivery.

A

Turning

B

Milling

C

Drilling

D

Technical Information

E

Index

S P K N 12 04 ED T21K R – DM

1

2

3

4

5

6

7

8

9

10

A

Turning

B

Milling

C











Drilling







D





Technical Information

E

Index

Insert shape	
A 	C 
H 	L 
M 	O 
P 	R 
S 	T 
W 	X Special
Z Special	















Clearance angle	
B 	C 
D 	E 
F 	N 
P 	









Tolerance class			
			
Code	I.C [mm]	m [mm]	S [mm]
A	±0,025	±0,005	±0,025
C	±0,025	±0,013	±0,025
E	±0,025	±0,025	±0,025
F	±0,013	±0,005	±0,025
G	±0,025	±0,025	±0,130
H	±0,013	±0,013	±0,025
J	±0,05-0,13	±0,005	±0,025
K	±0,05-0,13	±0,013	±0,025
L	±0,05-0,13	±0,025	±0,025
M	±0,05-0,13	±0,08-0,18	±0,130
N	±0,05-0,13	±0,08-0,18	±0,025
U	±0,08-0,25	±0,13-0,38	±0,130

1

2

3

Fastening features (metric)	
Insert shape	
A 	B 
C 	F 
G 	H 
J 	M 
N 	Q 
R 	T 
U 	W 
X Special	

Cutting edge length l [mm]	
Insert shape	
	
A	C, M
	
H, O, P	L
	
R	S
	
T	W

4

5

Insert thickness S [mm]			
Code	S	Code	S
00	0,79	05	5,56
T0	0,99	T5	5,95
01	1,59	06	6,35
T1	1,98	T6	6,75
02	2,38	07	7,94
T2	2,58	09	9,52
03	3,18	T9	9,72
T3	3,97	11	11,11
04	4,76	12	12,70
T4	4,96		

6

Angle			
Code	Kr	Code	an
A	45°	A	3°
D	60°	B	5°
E	75°	C	7°
F	85°	D	15°
P	90°	E	20°
Z	Special	F	25°
		G	30°
		N	0°
		P	11°
		Z	Special

7

Chamfer							
Code	Type	Code	Angle	Code	Width [mm]	Code	Position
F		0	5°	0	0,10	K	
E		1	10°	1	0,15	P	
T		2	15°	2	0,20	W	
S		3	20°	3	0,25	-	
		4	25°	4	0,30		
		5	30°	5	0,35		
				6	0,40		
				7	0,45		

8

Cutting direction	
Code	Description
R	Right
L	Left
N	Right and left

9

Chip breaker overview
(on page B20)

10

A

Turning

B

Milling

C

Drilling

D

Technical Information

E

Index

Guide for recommended cutting data – indexable milling

Indexable milling – group 1 (FMA07/11/12, FMD02, EMP09/13)

Material group	Composition / structure / heat treatment	Brinell hardness HB	Machining group	Starting values for cutting speed v_c (m/min)								
				HC (CVD)								
				YBC302		YBC401		YBD152		YBD252		
				a_e / D		a_e / D		a_e / D		a_e / D		
1/1 3/4		1/5		1/1 3/4		1/5		1/1 3/4		1/5		
P Unalloyed steel	ca. 0,15 % C	annealed	125	1	260	300	225	260				
	ca. 0,45 % C	annealed	190	2	225	255	195	225				
	ca. 0,45 % C	tempered	250	3	210	240	180	210				
	ca. 0,75 % C	annealed	270	4	185	210	160	185				
	ca. 0,75 % C	tempered	300	5	170	195	150	170				
P Low-alloyed steel		annealed	180	6	225	255	195	225				
		tempered	275	7	185	210	160	185				
		tempered	300	8	170	195	150	170				
		tempered	350	9	145	165	125	145				
P High-alloyed steel and high-alloyed tool steel		annealed	200	10	130	150	115	130				
		hardened and tempered	325	11	95	105	80	95				
M Stainless steel	ferritic/martensitic	annealed	200	12								
	martensitic	tempered	240	13								
	austenitic	quench hardened	180	14								
	austenitic-ferritic		230	15								
K Grey cast iron	perlitic/ferritic		180	16				370	430	320	370	
	perlitic (martensitic)		260	17				220	255	190	220	
K Cast iron with spheroidal graphite	ferritic		160	18				255	295	220	255	
	perlitic		250	19				170	200	145	170	
K Malleable cast iron	ferritic		130	20				305	355	265	305	
	perlitic		230	21				205	240	175	205	
N Aluminium wrought alloys	cannot be hardened		60	22								
	hardenable	hardened	100	23								
	$\leq 12\% \text{ Si}$, cannot be hardened		75	24								
	$\leq 12\% \text{ Si}$, hardenable	hardened	90	25								
N Cast aluminium alloys	$> 12\% \text{ Si}$, cannot be hardened		130	26								
	machining steel, PB > 1%		110	27								
	CuZn, CuSnZn		90	28								
S Copper and copper alloys (bronze/brass)	CuSn, Pb-free copper, electrolytic copper		100	29								
	Heat-resistant alloys	Fe-based alloys	annealed	200	30							
		hardened	280	31								
	Ni or Co base	annealed	250	32								
hardened		350	33									
Titanium alloys	cast	320	34									
	pure titanium		R_m 400	35								
H Hardened steel	α and β alloys	hardened	R_m 1050	36								
	hardened and tempered		55 HRC	37								
H Hard cast iron	hardened and tempered		60 HRC	38								
	cast		400	39								
H Hardened cast iron	hardened and tempered		55 HRC	40								
	Thermoplasts			41								
X Non-metallic materials	Thermosetting plastics			42								
	Plastic, glass-fibre reinforced GFRP			43								
	Plastic, carbon fibre reinforced CFRP			44								
	Graphite			45								
	Wood			46								

Note: The given cutting values are guide values, which were determined under ideal conditions.

The values have to be adapted in individual cases.

Feed rate recommendations on page B248

For examples of material for cutting tool groups view page D22.

Recommend feed rate

Indexable milling – group1 (FMA07/11/12, FMD02, EMP09/13)

5	Material group	Feed rate per cutting edge [mm]																			
		EMP09			EMP13			EMP13			FMA07			FMA07			FMA11				
		LNKT12			ANGX11			ANGX15			ONHU06			ONHU08			SNEG12				
		Application																			
		F	M	R	F	M	R	F	M	R	F	M	R	F	M	R	F	M	R		
P	Unalloyed steel		0,25	0,50		0,23			0,25		0,19	0,23		0,19	0,23		0,20	0,23			
	Low-alloyed steel		0,23	0,47		0,22			0,23		0,17	0,22		0,17	0,22		0,19	0,21			
	High-alloyed steel and high-alloyed tool steel		0,22	0,44		0,20			0,22		0,16	0,20		0,16	0,20		0,18	0,20			
M	Stainless steel		0,18	0,35													0,14	0,16			
K	Grey cast iron		0,28	0,55		0,26			0,28		0,20	0,26		0,20	0,26		0,22	0,25			
	Cast iron with spheroidal graphite		0,25	0,50		0,23			0,25		0,19	0,23		0,19	0,23		0,20	0,23			
	Malleable cast iron		0,25	0,50		0,23			0,25		0,19	0,23		0,19	0,23		0,20	0,23			
N	Aluminium wrought alloys					0,20			0,21												
	Aluminium-Gusslegierungen					0,20			0,21												
	Copper and copper alloys(bronze/brass)					0,18			0,19												
S	Heat-resistant alloys																				
	Titanium alloys																				
H	Hardened steel																				
	Hard cast iron																				
	Hardened cast iron																				
X	Non-metallic materials																				

1. Select the appropriate product family/cutting data group.
2. Select the used grade.
3. Determine the immersion.
4. Select the used material and read the cutting speed.
5. Please have a look at the detached feed rate recommendations.
6. Select the used tool, the machining mode and the used material.

A

Turning

B

Milling

C

Drilling

D

Technical Information

E

Index

Indexable milling – group 4 (BMR01/02/03/04, TMP01, CMZ01, CMA01, CMD01)

	Material group	Composition / structure / heat treatment		Brinell hardness HB	Machining group	Starting values for cutting speed v_c [m/min]							
						HC (CVD)							
						YBC302			YBC401				
						a_e / D			a_e / D				
1/1 3/4	1/5	1/20	1/1 3/4	1/5	1/20								
P	Unalloyed steel	approx. 0,15 % C	annealed	125	1	235	275	360	200	230	300		
		approx. 0,45 % C	annealed	190	2	200	235	310	170	200	260		
		approx. 0,45 % C	tempered	250	3	190	220	290	160	185	245		
		approx. 0,75 % C	annealed	270	4	165	195	255	140	165	215		
		approx. 0,75 % C	tempered	300	5	155	180	235	130	150	195		
	Low-alloyed steel		annealed	180	6	200	235	310	170	200	260		
			tempered	275	7	165	195	255	140	165	215		
			tempered	300	8	155	180	235	130	150	195		
		tempered	350	9	130	155	205	110	130	170			
High-alloyed steel and high-alloyed tool steel		annealed	200	10	120	140	185	100	115	150			
		hardened and tempered	325	11	85	100	130	70	85	115			
M	Stainless steel	ferritic/martensitic	annealed	200	12								
		martensitic	tempered	240	13								
		austenitic	quench hardened	180	14								
		austenitic-ferritic		230	15								
K	Grey cast iron	perlitic/ferritic		180	16								
		perlitic (martensitic)		260	17								
	Cast iron with spheroidal graphite	ferritic		160	18								
		perlitic		250	19								
Malleable cast iron	ferritic		130	20									
	perlitic		230	21									
N	Aluminium wrought alloys	cannot be hardened		60	22								
		hardenable	hardened	100	23								
	Cast aluminium alloys	$\leq 12\% \text{ Si}$, cannot be hardened		75	24								
		$\leq 12\% \text{ Si}$, hardenable	hardened	90	25								
		$> 12\% \text{ Si}$, cannot be hardened		130	26								
	Copper and copper alloys (bronze/brass)	machining steel, PB > 1%		110	27								
CuZn, CuSnZn		90	28										
CuSn, Pb-free copper, electrolytic copper		100	29										
S	Heat-resistant alloys	Fe-based alloys	annealed	200	30								
			hardened	280	31								
		Ni or Co base	annealed	250	32								
			hardened	350	33								
		cast	320	34									
Titanium alloys	pure titanium		R_m 400	35									
	α and β alloys	hardened		R_m 1050	36								
H	Hardened steel		hardened and tempered	55 HRC	37								
			hardened and tempered	60 HRC	38								
	Hard cast iron		cast	400	39								
	Hardened cast iron		hardened and tempered	55 HRC	40								
X	Non-metallic materials	Thermoplasts			41								
		Thermosetting plastics			42								
		Plastic, glass-fibre reinforced GFRP			43								
		Plastic, carbon fibre reinforced CFRP			44								
		Graphite			45								
		Wood			46								

Note: The given cutting values are guide values, which were determined under ideal conditions.
 The values have to be adapted in individual cases.
 Feed rate recommendations on page B254.
 For examples of material for cutting tool groups view page D11.

Starting values for cutting speed v_c [m/min]																									
HC (CVD)									HC (PVD)																
YBD152			YBD252			YBM253			YBG102			YBG152			YB9320			YBG205							
a_e / D			a_e / D			a_e / D			a_e / D			a_e / D			a_e / D			a_e / D							
1/1 3/4	1/5	1/20	1/1 3/4	1/5	1/20	1/1 3/4	1/5	1/20	1/1 3/4	1/5	1/20	1/1 3/4	1/5	1/20	1/1 3/4	1/5	1/20	1/1 3/4	1/5	1/20					
								235	275	360	245	285	375	230	265	345	220	255	335	210	245	320			
								200	235	310	210	245	320	200	230	300	190	220	290	180	210	275			
								190	220	290	200	230	300	185	215	280	180	205	270	170	200	260			
								165	195	255	175	200	260	165	190	250	155	180	235	150	175	230			
								155	180	235	160	190	250	150	175	230	145	170	225	140	160	210			
								200	235	310	210	245	320	200	230	300	190	220	290	180	210	275			
								165	195	255	175	200	260	165	190	250	155	180	235	150	175	230			
								155	180	235	160	190	250	150	175	230	145	170	225	140	160	210			
								130	155	205	135	160	210	130	150	195	125	145	190	120	135	180			
								120	140	185	125	145	190	115	135	180	110	130	170	105	125	165			
								85	100	130	90	100	130	85	95	125	80	90	120	75	90	120			
								120	140	180	125	145	190	115	135	175	110	130	170	105	125	160			
								100	120	155	105	120	160	100	115	145	95	110	145	90	105	135			
								125	150	195	130	155	200	125	145	185	120	140	180	115	130	170			
								100	120	155	105	120	160	100	115	145	95	110	145	90	105	135			
	300	345	450	260	300	390								270	315	410	255	295	385	245	285	375	235	275	360
	180	210	275	155	180	235								160	190	250	150	175	230	145	170	225	140	160	210
	210	245	320	180	210	275								185	215	280	175	200	260	165	195	255	160	185	245
	140	165	215	120	140	185								125	145	190	115	135	180	110	130	170	105	125	165
	250	290	380	215	250	325								225	260	340	210	240	315	200	230	300	190	225	295
	170	200	260	145	165	215								150	175	230	140	160	210	135	155	205	130	150	195

HC Coated carbide
 HT Uncoated carbide, main component (TiC) o. (TiN), cermet
 HC₁ Coated cermet
 HW Uncoated carbide, main component (WC)

A
Turning
B
Milling
C
Drilling
D
Technical Information
E
Index



Indexable milling – group 4 (BMR01/02/03/04, TMP01, CMZ01, CMA01, CMD01)

	Material group	Composition / structure / heat treatment		Brinell hardness HB	Machining group	Starting values for cutting speed v_c [m/min]						
						HC (PVD)						
						YBG212			YBG252			
						a_e / D			a_e / D			
	1/1 3/4	1/5	1/20	1/1 3/4	1/5	1/20						
P	Unalloyed steel	approx. 0,15 % C	annealed	125	1	215	250	325	205	240	315	
		approx. 0,45 % C	annealed	190	2	185	215	280	175	205	270	
		approx. 0,45 % C	tempered	250	3	175	200	260	165	195	255	
		approx. 0,75 % C	annealed	270	4	155	175	230	145	170	225	
		approx. 0,75 % C	tempered	300	5	140	165	215	135	160	210	
	Low-alloyed steel		annealed	180	6	185	215	280	175	205	270	
			tempered	275	7	155	175	230	145	170	225	
			tempered	300	8	140	165	215	135	160	210	
			tempered	350	9	120	140	185	115	135	180	
	High-alloyed steel and high-alloyed tool steel		annealed	200	10	110	125	165	105	120	160	
		hardened and tempered	325	11	80	90	120	75	85	115		
M	Stainless steel	ferritic/martensitic	annealed	200	12	110	125	165	105	120	160	
			martensitic	tempered	240	13	95	105	140	90	105	135
			austenitic	quench hardened	180	14	115	135	175	110	130	170
			austenitic-ferritic		230	15	95	105	140	90	105	135
K	Grey cast iron	perlitic/ferritic		180	16	240	280	365	230	265	345	
			perlitic (martensitic)	260	17	140	165	215	135	160	210	
	Cast iron with spheroidal graphite	ferritic		160	18	165	190	250	155	180	235	
			perlitic	250	19	110	125	165	105	120	160	
Malleable cast iron	ferritic		130	20	195	225	295	185	220	290		
		perlitic	230	21	130	150	195	125	145	190		
N	Aluminium wrought alloys	cannot be hardened		60	22							
		hardenable	hardened	100	23							
	Cast aluminium alloys	$\leq 12\% \text{ Si}$, cannot be hardened		75	24							
		$\leq 12\% \text{ Si}$, hardenable	hardened	90	25							
		$> 12\% \text{ Si}$, cannot be hardened		130	26							
	Copper and copper alloys (bronze/brass)	machining steel, PB > 1%		110	27							
		CuZn, CuSnZn		90	28							
CuSn, Pb-free copper, electrolytic copper		100	29									
S	Heat-resistant alloys	Fe-based alloys	annealed	200	30							
			hardened	280	31							
		Ni or Co base	annealed	250	32							
			hardened	350	33							
		cast	320	34								
Titanium alloys	pure titanium		R_m 400	35								
	α and β alloys	hardened		R_m 1050	36							
H	Hardened steel		hardened and tempered	55 HRC	37							
			hardened and tempered	60 HRC	38							
	Hard cast iron		cast	400	39							
	Hardened cast iron		hardened and tempered	55 HRC	40							
X	Non-metallic materials	Thermoplasts			41							
		Thermosetting plastics			42							
		Plastic, glass-fibre reinforced GFRP			43							
		Plastic, carbon fibre reinforced CFRP			44							
		Graphite			45							
		Wood			46							

Note: The given cutting values are guide values, which were determined under ideal conditions.
 The values have to be adapted in individual cases.
 Feed rate recommendations on page B254.
 For examples of material for cutting tool groups view page D11.

Recommended feed rate

Indexable milling – group 3 (FMR01/02/03/04) Circular milling

Material group		Feed rate per cutting edge [mm]							
		FMR01	FMR01	FMR02	FMR02	FMR02	FMR03		
		RCKT10	RC*12	RC*12	RCKT16	RCKT20	RDKW07		
		Tool diameter [mm]							
		25-32	40-50	50-100	63-125	160-200	80-125	160-250	15
P	Unalloyed steel	0,12	0,16	0,18	0,24	0,32	0,26	0,35	0,07
	Low-alloyed steel	0,11	0,14	0,16	0,21	0,28	0,23	0,31	0,06
	High-alloyed steel and high-alloyed tool steel	0,10	0,13	0,14	0,19	0,26	0,21	0,28	0,06
M	Stainless steel	0,07	0,09	0,10	0,14	0,18	0,15	0,20	0,04
K	Grey cast iron	0,11	0,14	0,16	0,22	0,29	0,23	0,32	0,06
	Cast iron with spheroidal graphite	0,10	0,13	0,14	0,19	0,26	0,21	0,28	0,06
	Malleable cast iron	0,10	0,13	0,14	0,19	0,26	0,21	0,28	0,06
N	Aluminium wrought alloys								
	Aluminum cast alloys								
	Copper and copper alloys (bronze/brass)								
S	Heat-resistant alloys								
	Titanium alloys								
H	Hardened steel								
	Hard cast iron								
	Hardened cast iron								
X	Non-metallic materials								

Note: The given cutting values are guide values, which were determined under ideal conditions.
The values have to be adapted in individual cases.

Indexable milling – group 4 (BMR01/02/03/04, TMP01, CMZ01, CMA01, CMD01)

Material group		Feed rate per cutting edge [mm]								
		BMR01	BMR01	BMR01	BMR01	BMR02	BMR02	BMR02	BMR03	BMR03
		ZD*08 / SP*06	ZD*11 / SP*06	ZD*13 / SP*09	ZP*22 / SP*12	ROHX12	ROHX16	ROHX20	-	-
		Tool diameter [mm]								
		20	25	32	40-63	12	16	20	16	20
P	Unalloyed steel	0,14	0,21	0,26	0,32	0,10	0,13	0,14	0,13	0,14
	Low-alloyed steel	0,10	0,15	0,18	0,22	0,07	0,09	0,10	0,09	0,10
	High-alloyed steel and high-alloyed tool steel	0,09	0,14	0,17	0,21	0,07	0,08	0,09	0,08	0,09
M	Stainless steel	0,08	0,12	0,14	0,18	0,06	0,07	0,08	0,07	0,08
K	Grey cast iron	0,18	0,27	0,34	0,42	0,13	0,17	0,18	0,17	0,18
	Cast iron with spheroidal graphite	0,13	0,20	0,25	0,30	0,10	0,12	0,13	0,12	0,13
	Malleable cast iron	0,14	0,21	0,26	0,32	0,10	0,13	0,14	0,13	0,14
N	Aluminum wrought alloys									
	Aluminum cast alloys									
	Copper and copper alloys (bronze/brass)									
S	Heat-resistant alloys									
	Titanium alloys									
H	Hardened steel									
	Hard cast iron									
	Hardened cast iron									
X	Non-metallic materials									

Note: The given cutting values are guide values, which were determined under ideal conditions.
The values have to be adapted in individual cases.

A

Turning

Feed rate per cutting edge [mm]						
FMR03	FMR03	FMR04	FMR04	FMR04		
RDKW08	RD*10	RD*12	RDKW16	RDKW20		
Tool diameter [mm]						
16-25	32	50-63	80-100	125-160		
0,07	0,12	0,17	0,24	0,30		
0,06	0,11	0,15	0,21	0,26		
0,06	0,10	0,14	0,19	0,24		
0,04	0,07	0,10	0,14	0,17		
0,06	0,11	0,15	0,22	0,27		
0,06	0,10	0,14	0,19	0,24		
0,06	0,10	0,14	0,19	0,24		
	0,10	0,11				
	0,10	0,11				
	0,10	0,11				

B

Milling

C

Drilling

Feed rate per cutting edge [mm]												
BMR03	BMR03	BMR03	BMR04	BMR04	BMR04	BMR04	BMR04	BMR04	CMZ01	CMA01	CMD01	
-	-	-	ZOHX12	ZOHX16	ZOHX20	ZOHX25	ZOHX30		SPMT12	SPMT12	SPMT12	
Tool diameter [mm]												
25	30-32	40-50	12	16	20	25	30	12-32	12-32	12-36		
0,21	0,26	0,30	0,10	0,13	0,14	0,16	0,17	0,23	0,23	0,23		
0,15	0,18	0,21	0,07	0,09	0,10	0,11	0,12	0,16	0,16	0,16		
0,14	0,17	0,20	0,07	0,08	0,09	0,10	0,11	0,15	0,15	0,15		
0,12	0,14	0,17	0,06	0,07	0,08	0,09	0,09	0,13	0,13	0,13		
0,27	0,34	0,39	0,13	0,17	0,18	0,21	0,22	0,30	0,30	0,30		
0,20	0,25	0,29	0,10	0,12	0,13	0,15	0,16	0,22	0,22	0,22		
0,21	0,26	0,30	0,10	0,13	0,14	0,16	0,17	0,23	0,23	0,23		













D

Technical Information

E

Index

Chamfer milling

Series	Milling body	Inserts	Kr	Application						Features	Page
				P	M	K	N	S	H		
CMZ01		 SPMT1204	30°	✓	✓	✓				<ul style="list-style-type: none"> • Diameter range Ø12 – 32 mm • For steel, stainless steel and cast iron • Chamfer milling cutter 30° 	B185
CMZ01		 SPMT1204	30°	✓	✓	✓				<ul style="list-style-type: none"> • Diameter range Ø12 – 32 mm • For steel, stainless steel and cast iron • Chamfer milling cutter 30° 	B183
CMA01		 SPMT1204	45°	✓	✓	✓				<ul style="list-style-type: none"> • Diameter range Ø12 – 32 mm • For steel, stainless steel and cast iron • Chamfer milling cutter 45° • Weldon shank 	B187
CMA01		 SPMT1204	45°	✓	✓	✓				<ul style="list-style-type: none"> • Diameter range Ø12 – 32 mm • For steel, stainless steel and cast iron • Chamfer milling cutter 45° • Weldon shank 	B189
CMD01		 SPMT1204	60°	✓	✓	✓				<ul style="list-style-type: none"> • Diameter range Ø12 – 32 mm • For steel, stainless steel and cast iron • Chamfer milling cutter 60° • Weldon shank 	B191
CMD01		 SPMT1204	60°	✓	✓	✓				<ul style="list-style-type: none"> • Diameter range Ø12 – 32 mm • For steel, stainless steel and cast iron • Chamfer milling cutter 60° • Weldon shank 	B193

✓ Very suitable ✓ Suitable

A

Turning

B

Milling

C

Drilling



D

Technical Information

E

Index

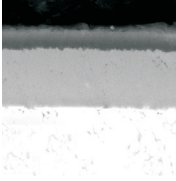
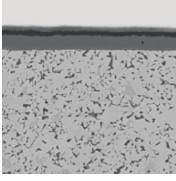
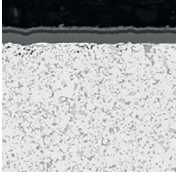
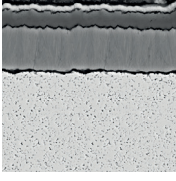
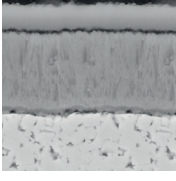
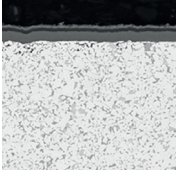
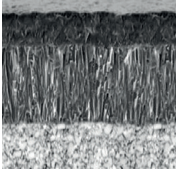
Coated cemented carbide CVD

Grade	ISO	Micro structure	Grade description
YBC302	P20 - P35		CVD coated P20-P35 carbide grade for medium operation to roughing of steel at higher cutting speed. Optimal performance of wear resistance and toughness for a wide application field.
YBC301	P20 - P35		CVD coated P20-P35 carbide grade for medium operation to roughing of steel at lower cutting speed.
YBC401	P30 - P50 M30 - M40		CVD coated P30-P50/M30-M40 carbide grade for roughing operation of steel at lower cutting speed and unstable condition.
YBM251	P20 - P30 M15 - M35		CVD coated P20-P30/M15-M35 carbide grade for medium to roughing operation in stainless steel and steel with wide application field. Good wear resistance and capability against plastic deformation at normal cutting speed.
YBM253	M15 - M35		CVD coated M15-M35 carbide grade for medium to roughing operation in stainless steel with wide application field. High wear resistance and capability against plastic deformation at higher cutting speed.
YBM351	P25 - P40 M20 - M40		CVD coated P25-P40/M25-M40 carbide grade for roughing operation in stainless steel and steel. Good wear resistance and edge stability at normal cutting speed.
YBD152	K10 - K25		CVD coated K10-K25 carbide substrate. Optimized for medium to roughing operation of cast iron. Good wear resistance and toughness at higher cutting speed.
YBD252	K20 - K35		CVD coated K20-K35 carbide substrate. Optimized for medium to roughing operation of cast iron and Steel. Good wear resistance and toughness at higher cutting speed.

A

Turning

B

Milling

C

Drilling

DTechnical
Information**E**

Index

Coated cemented carbide PVD

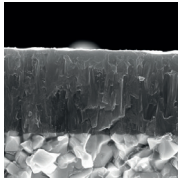
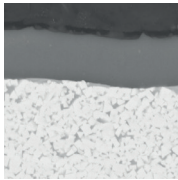
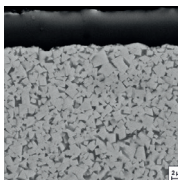
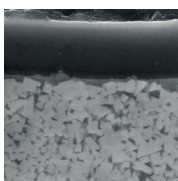
Grade	ISO	Micro structure	Grade description
A Turning	YBG101	N05–N20	 <p>PVD coated N05–N20 carbide substrate for finishing to semi-finishing in aluminium materials. Coating only on the top face, in combination with the aluminium chip breakers, prevents built-up edges and gives a smooth cut.</p>
B Milling	YBG202	P10 - P30 M10-M25	 <p>PVD coated P10–P30/M10–M25 carbide substrate for finishing to medium application of stainless steel and steel (milling). Good wear resistance in a wide application field.</p>
D Technical Information	YBS203	S15 – S25	 <p>Turning and milling grades for processing heat-resistant materials. A special carbon substrate and the latest PVD coating technology enable a very good wear behaviour, high fracture toughness and high thermal stability.</p>
YBG302	P15 - P30 M25 - M40	 <p>PVD multilayer coated P10–P30/M10–M25 carbide substrate for finishing to medium machining of stainless steel, super alloys and steel (grooving/milling). Optimised coating stability for higher wear resistance and thermal stability in a wide range of applications.</p>	
			YBG302

Coated cemented carbide PVD

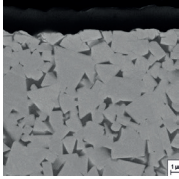
Grade	ISO	Micro structure	Grade description
YBS303	S25 - S35		Milling grade for machining titanium alloys. A tough carbide substrate and the latest PVD coating technology with increased impact resistance and high thermal stability.

Cermet

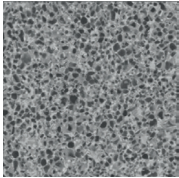
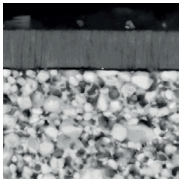
Grade	ISO	Micro structure	Grade description
YNG151	P05 - P15		Uncoated P05-P15 cermet grade for fine finishing operation of steel and stainless steel. Good resistance against plastic deformation for good surface finishing.
YNG151C	P05 - P15		PVD coated P05-P15 cermet grade for fine finishing operation of steel and stainless steel. Good wear resistance and capability against plastic deformation for good surface roughness.

Uncoated cemented carbide

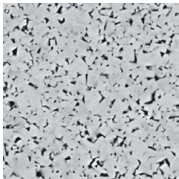
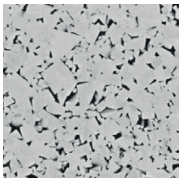
Grade	ISO	Micro structure	Grade description
YD101	N05 - N25 K05 - K20		Uncoated K05-K20/N05-N20 carbide substrate for fine to medium application in aluminum and other material.
YD201	K10 - K30 N10 - N30		Uncoated K10-K30/N10-N30 carbide substrate for medium application in aluminum and other material.

A

Turning

B

Milling

C

Drilling

DTechnical
Information**E**

Index

Application fields of grades – indexable milling

	ISO	HC ¹ (CVD)	HC ¹ (PVD)	HT	HC ²	HW	PCBN/PCD
P	P01		YBG102		YNG151C		
	P10		YBG202	YNG151			
	P20	YBC301	YBG205		YNG151C		
	P30	YBC401	YBG302			YC305	
	P40	YBM351	YB9320				
M	M01		YBG102		YNG151C		
	M10	YBM251	YBG202	YNG151			
	M20	YBM253	YBG205		YNG151C		
	M30	YBM351	YBG302			YC305	
	M40	YBC401	YB9320				
K	K01		YBG102				
	K10	YBD152	YBG152				
	K20	YBD252	YBG202			YD201	
	K30						
	K40						
N	N01					YD051	
	N10		YBG101			YD101	
	N20		YBG202				YD201
	N30						
S	S01		YBG102				
	S10		YBG202				
	S20		YBG205				
	S30		YBS203				
			YBS303				
H	H01		YBG102				
	H10						
	H20						
	H30						

P	Steel
M	Stainless steel
K	Cast iron

N	Non-ferrous metals
S	Heat-resistant alloys
H	Hardened materials

HC ¹	Coated carbide
HT	Uncoated cermet
HC ²	Coated carbide
HW	Uncoated carbide