

Profile milling

BMR02

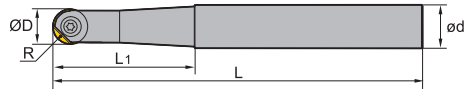
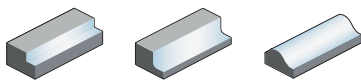

Article	*	Stock	Dimensions [mm]					kg	Inserts
			R	ØD	ød	L ₁	L		
BMR02-012-G16-S	●		6	12	16	40	110	0.1	ROHX1203
BMR02-012-G16-M	●		6	12	16	50	130	0.2	
BMR02-012-G16-L	●		6	12	16	50	160	0.2	
BMR02-016-G20-S	●		8	16	20	45	140	0.3	ROHX1604
BMR02-016-G20-M	●		8	16	20	65	170	0.3	
BMR02-016-G20-L	●		8	16	20	65	200	0.4	
BMR02-020-G25-S	●		10	20	25	60	160	0.5	ROHX2005
BMR02-020-G25-M	●		10	20	25	80	200	0.6	
BMR02-020-G25-L	●		10	20	25	80	240	0.8	

● Ex stock ○ On demand

* With internal cooling

Spare parts		ROHX1203	ROHX1604	ROHX2005	
Insert	ØD	12	16	20	
Screw (insert)		I70M4×10TT (3.4 Nm)	I70M5×12TT (6.7 Nm)	I70M5×16TT (6.7 Nm)	
Wrench (insert)		WT15IS	WT20IS	WT20IS	



System code > B26

Grade selection > B24



Technical info > B527

Cutting data > B230

ROHX	L	I.C	S	d
12 03	8.5	12	3	4
16 04	11.3	16	4	5
20 05	14.1	20	5	5

-  Ideal machining conditions
-  Normal machining conditions
-  Unfavourable machining conditions

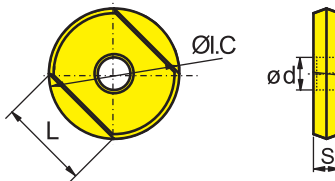
Milling inserts

RO** positive insert		HC ¹ (CVD)						HC ¹ (PVD)					HT	HC ²	HW									
	P																							
	M																							
	K																							
	N																							
	S																							
	H																							
ISO		YBC302	YBC301	YBC401	YBM253	YBM251	YBM351	YBD152	YBD252	YBG101	YBG102	YBG202	YBG212	YBS203	YBG205	YB9320	YBG302	YBS303	YBG252	YNG151	YNG151C	YD101	YD201	
	ROHX1604																							
	ROHX1203										○	○							●					
	ROHX2005										○								●					

● Ex stock ○ On demand

HC¹ Coated carbide
 HT Uncoated cermet
 HC² Coated cermet
 HW Uncoated carbide

A

Turning

B

Milling

C

Drilling

D

Technical Information

E

Index

System code > B26

Grade selection > B24

Technical info > B527

Cutting data > B230





FM A 12 050 – A22 O – N 06 – 04 (L) (C)

1 2 3 4 5 6 7 8 9 10 11

Type	
Code	Description
BM	Profile milling
CM	Chamfer milling
EM	Square shoulder milling
FM	Face milling
HM	Helical milling
SM	Slot milling
TM	T-slot milling
XM	Special

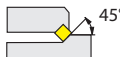
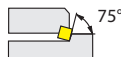
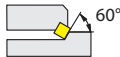
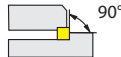
1

Entering angle			
A		E	
D		P	
R			

2

Serial number

3





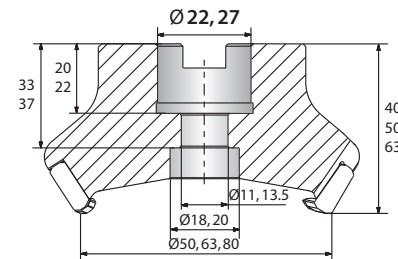
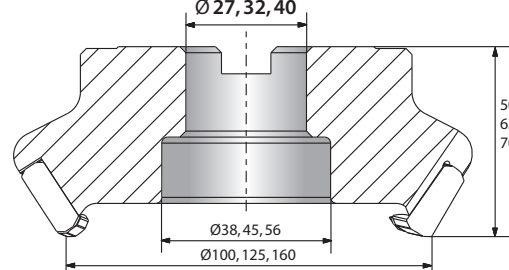
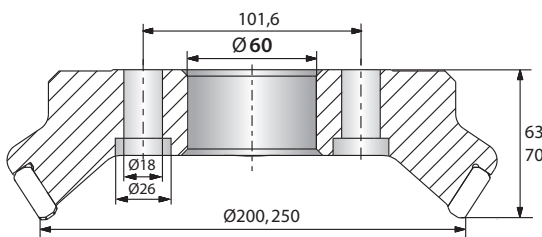
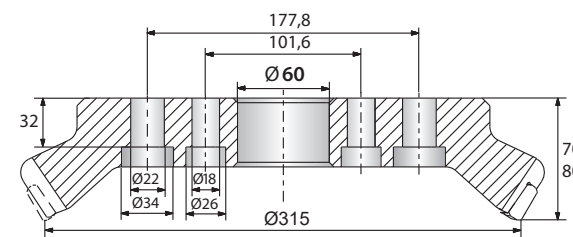





Nominal diameter [mm]	
Code	Description
025	25
050	50
160	160
315	315
...	

4







Type and size of tool holders			
Code	Type	Code	Type
A	<p>Nominal diameter $\varnothing 50 - 80$ mm</p> 	B	<p>Nominal diameter $\varnothing 100 - 160$ mm</p> 
C	<p>Nominal diameter $\varnothing 200 - 250$ mm</p> 	D	<p>Nominal diameter $\varnothing 315$ mm</p> 
G	Straight shank	XP	Weldon shank
K	Bore with keyway		

5









With respect to mounting please adhere to the information provided by the tool holder manufacturer.

Insert shape	
A 	C 
H 	L 
M 	O 
P 	R 
S 	T 
W 	X Special
Z Special	

6

Clearance angle	
B 	C 
D 	E 
F 	N 
P 	

7

Cutting edge length l [mm]	
Insert shape	
	
A	C, M
	
H, O, P	L
	
R	S
	
T	W

8

Number of teeth

9

Cutting direction	
Code	Description
L	Left

10

With inner cooling

11



Tools with B coupling and inner coolant supply require the following spare parts:





Coolant clamp screw



Coolant shower plate



Spare parts (B coupling with inner coolant supply)

		B27	B32	B40	B40
	Ø	80	100	125	160
	Coolant clamp screw	LDB27C	LDB32C	LDB40C	LDB40C
	Coolant shower plate	B27-002-CP	B32-002-CP	B40-002-CP	B40-003-CP

When purchasing tools with inner coolant supply and B coupling these spare parts are included in delivery.

A

Turning

B

Milling

C

Drilling

D

Technical Information

E

Index

S P K N 12 04 ED T21K R – DM

1

2

3

4

5

6

7

8

9

10

A

Turning

B

Milling

C

Drilling

D

Technical Information

E

Index

Insert shape	
A	C
H	L
M	O
P	R
S	T
W	X Special
Z Special	

Clearance angle	
B	C
D	E
F	N
P	

Tolerance class			
Code	I.C [mm]	m [mm]	S [mm]
A	±0,025	±0,005	±0,025
C	±0,025	±0,013	±0,025
E	±0,025	±0,025	±0,025
F	±0,013	±0,005	±0,025
G	±0,025	±0,025	±0,130
H	±0,013	±0,013	±0,025
J	±0,05-0,13	±0,005	±0,025
K	±0,05-0,13	±0,013	±0,025
L	±0,05-0,13	±0,025	±0,025
M	±0,05-0,13	±0,08-0,18	±0,130
N	±0,05-0,13	±0,08-0,18	±0,025
U	±0,08-0,25	±0,13-0,38	±0,130

1

2

3

Fastening features (metric)	
Insert shape	
A	B
C	F
G	H
J	M
N	Q
R	T
U	W
X Special	

Cutting edge length l [mm]	
Insert shape	
A	C, M
H, O, P	L
R	S
T	W

4

5

Insert thickness S [mm]			
Code	S	Code	S
00	0,79	05	5,56
T0	0,99	T5	5,95
01	1,59	06	6,35
T1	1,98	T6	6,75
02	2,38	07	7,94
T2	2,58	09	9,52
03	3,18	T9	9,72
T3	3,97	11	11,11
04	4,76	12	12,70
T4	4,96		

6

Angle			
Code	Kr	Code	an
A	45°	A	3°
D	60°	B	5°
E	75°	C	7°
F	85°	D	15°
P	90°	E	20°
Z	Special	F	25°
		G	30°
		N	0°
		P	11°
		Z	Special

7

Chamfer							
Code	Type	Code	Angle	Code	Width [mm]	Code	Position
F		0	5°	0	0,10	K	
E		1	10°	1	0,15		
T		2	15°	2	0,20		
S		3	20°	3	0,25		
		4	25°	4	0,30		
		5	30°	5	0,35		
				6	0,40		
				7	0,45		
						W	
						-	

8

Cutting direction	
Code	Description
R	Right
L	Left
N	Right and left

9

Chip breaker overview
(on page B20)

10

A

Turning

B

Milling

C

Drilling

D

Technical Information

E

Index

Guide for recommended cutting data – indexable milling

Indexable milling – group 1 (FMA07/11/12, FMD02, EMP09/13)

Material group	Composition / structure / heat treatment	Brinell hardness HB	Machining group	Starting values for cutting speed v_c (m/min)								
				HC (CVD)								
				YBC302		YBC401		YBD152		YBD252		
				a_p / D		a_p / D		a_p / D		a_p / D		
				1/1 3/4	1/5	1/1 3/4	1/5	1/1 3/4	1/5			
P Unalloyed steel	ca. 0,15 % C	annealed	125	1	260	300	225	260				
	ca. 0,45 % C	annealed	190	2	225	255	195	225				
	ca. 0,45 % C	tempered	250	3	210	240	180	210				
	ca. 0,75 % C	annealed	270	4	185	210	160	185				
	ca. 0,75 % C	tempered	300	5	170	195	150	170				
P Low-alloyed steel		annealed	180	6	225	255	195	225				
		tempered	275	7	185	210	160	185				
		tempered	300	8	170	195	150	170				
		tempered	350	9	145	165	125	145				
P High-alloyed steel and high-alloyed tool steel		annealed	200	10	130	150	115	130				
		hardened and tempered	325	11	95	105	80	95				
M Stainless steel	ferritic/martensitic	annealed	200	12								
	martensitic	tempered	240	13								
	austenitic	quench hardened	180	14								
	austenitic-ferritic		230	15								
K Grey cast iron	perlite/ferritic		180	16				370	430	320	370	
	perlite (martensitic)		260	17				220	255	190	220	
K Cast iron with spheroidal graphite	ferritic		160	18				255	295	220	255	
	perlite		250	19				170	200	145	170	
K Malleable cast iron	ferritic		130	20				305	355	265	305	
	perlite		230	21				205	240	175	205	
N Aluminium wrought alloys	cannot be hardened		60	22								
	hardenable	hardened	100	23								
	$\leq 12\% \text{ Si}$, cannot be hardened		75	24								
	$\leq 12\% \text{ Si}$, hardenable	hardened	90	25								
N Cast aluminium alloys	$> 12\% \text{ Si}$, cannot be hardened		130	26								
	machining steel, PB > 1%		110	27								
	CuZn, CuSnZn		90	28								
S Copper and copper alloys (bronze/brass)	CuSn, Pb-free copper, electrolytic copper		100	29								
	Heat-resistant alloys	Fe-based alloys	annealed	200	30							
		hardened	280	31								
	Ni or Co base	annealed	250	32								
hardened		350	33									
Titanium alloys	cast	320	34									
	pure titanium		R_m 400	35								
H Hardened steel	α and β alloys	hardened	R_m 1050	36								
	hardened and tempered		55 HRC	37								
H Hard cast iron	hardened and tempered		60 HRC	38								
	cast		400	39								
H Hardened cast iron	hardened and tempered		55 HRC	40								
	Thermoplasts			41								
X Non-metallic materials	Thermosetting plastics			42								
	Plastic, glass-fibre reinforced GFRP			43								
	Plastic, carbon fibre reinforced CFRP			44								
	Graphite			45								
	Wood			46								

Note: The given cutting values are guide values, which were determined under ideal conditions. The values have to be adapted in individual cases. Feed rate recommendations on page B248. For examples of material for cutting tool groups view page D22.

Recommend feed rate

Indexable milling – group1 (FMA07/11/12, FMD02, EMP09/13)

5	Material group	Feed rate per cutting edge [mm]																		
		EMP09			EMP13			EMP13			FMA07			FMA07			FMA11			
		LNKT12			ANGX11			ANGX15			ONHU06			ONHU08			SNEG12			
		Application																		
		F	M	R	F	M	R	F	M	R	F	M	R	F	M	R	F	M	R	
P	Unalloyed steel		0,25	0,50		0,23			0,25		0,19	0,23		0,19	0,23		0,20	0,23		
	Low-alloyed steel		0,23	0,47		0,22			0,23		0,17	0,22		0,17	0,22		0,19	0,21		
	High-alloyed steel and high-alloyed tool steel		0,22	0,44		0,20			0,22		0,16	0,20		0,16	0,20		0,18	0,20		
M	Stainless steel		0,18	0,35													0,14	0,16		
K	Grey cast iron		0,28	0,55		0,26			0,28		0,20	0,26		0,20	0,26		0,22	0,25		
	Cast iron with spheroidal graphite		0,25	0,50		0,23			0,25		0,19	0,23		0,19	0,23		0,20	0,23		
	Malleable cast iron		0,25	0,50		0,23			0,25		0,19	0,23		0,19	0,23		0,20	0,23		
N	Aluminium wrought alloys					0,20			0,21											
	Aluminium-Gusslegierungen					0,20			0,21											
	Copper and copper alloys(bronze/brass)					0,18			0,19											
S	Heat-resistant alloys																			
	Titanium alloys																			
H	Hardened steel																			
	Hard cast iron																			
	Hardened cast iron																			
X	Non-metallic materials																			

1. Select the appropriate product family/cutting data group.
2. Select the used grade.
3. Determine the immersion.
4. Select the used material and read the cutting speed.
5. Please have a look at the detached feed rate recommendations.
6. Select the used tool, the machining mode and the used material.

A

Turning

B

Milling

C

Drilling

D

Technical Information

E

Index

Indexable milling – group 4 (BMR01/02/03/04, TMP01, CMZ01, CMA01, CMD01)

	Material group	Composition / structure / heat treatment		Brinell hardness HB	Machining group	Starting values for cutting speed v_c [m/min]								
						HC (CVD)								
						YBC302			YBC401					
						a_e / D			a_e / D					
1/1 3/4	1/5	1/20	1/1 3/4	1/5	1/20									
A Turning	P Unalloyed steel	approx. 0,15 % C	annealed	125	1	235	275	360	200	230	300			
		approx. 0,45 % C	annealed	190	2	200	235	310	170	200	260			
		approx. 0,45 % C	tempered	250	3	190	220	290	160	185	245			
		approx. 0,75 % C	annealed	270	4	165	195	255	140	165	215			
		approx. 0,75 % C	tempered	300	5	155	180	235	130	150	195			
	B Milling	P Low-alloyed steel		annealed	180	6	200	235	310	170	200	260		
				tempered	275	7	165	195	255	140	165	215		
				tempered	300	8	155	180	235	130	150	195		
				tempered	350	9	130	155	205	110	130	170		
	C Drilling	High-alloyed steel and high-alloyed tool steel		annealed	200	10	120	140	185	100	115	150		
			hardened and tempered	325	11	85	100	130	70	85	115			
D Technical Information	M Stainless steel	ferritic/martensitic	annealed	200	12									
			martensitic	tempered	240	13								
			austenitic	quench hardened	180	14								
			austenitic-ferritic		230	15								
E Index	Grey cast iron		perlitic/ferritic	180	16									
			perlitic (martensitic)	260	17									
	Cast iron with spheroidal graphite		ferritic	160	18									
			perlitic	250	19									
Malleable cast iron		ferritic	130	20										
		perlitic	230	21										
F Index	Aluminium wrought alloys		cannot be hardened	60	22									
			hardenable	hardened	100	23								
	Cast aluminium alloys		$\leq 12\% \text{ Si}$, cannot be hardened	75	24									
			$\leq 12\% \text{ Si}$, hardenable	hardened	90	25								
			$> 12\% \text{ Si}$, cannot be hardened		130	26								
	Copper and copper alloys (bronze/brass)		machining steel, PB > 1%	110	27									
		CuZn, CuSnZn	90	28										
		CuSn, Pb-free copper, electrolytic copper	100	29										
G Index	Heat-resistant alloys	Fe-based alloys		annealed	200	30								
				hardened	280	31								
		Ni or Co base		annealed	250	32								
				hardened	350	33								
				cast	320	34								
Titanium alloys		pure titanium	$R_m 400$	35										
		α and β alloys	hardened	$R_m 1050$	36									
H Index	Hardened steel		hardened and tempered	55 HRC	37									
			hardened and tempered	60 HRC	38									
	Hard cast iron		cast	400	39									
	Hardened cast iron		hardened and tempered	55 HRC	40									
I Index	X Non-metallic materials		Thermoplasts		41									
			Thermosetting plastics		42									
			Plastic, glass-fibre reinforced GFRP		43									
			Plastic, carbon fibre reinforced CFRP		44									
			Graphite		45									
			Wood		46									

Note: The given cutting values are guide values, which were determined under ideal conditions.
 The values have to be adapted in individual cases.
 Feed rate recommendations on page B254.
 For examples of material for cutting tool groups view page D11.

Starting values for cutting speed v_c [m/min]																						
HC (CVD)									HC (PVD)													
YBD152			YBD252			YBM253			YBG102			YBG152			YB9320			YBG205				
a_e / D			a_e / D			a_e / D			a_e / D			a_e / D			a_e / D			a_e / D				
1/1 3/4	1/5	1/20	1/1 3/4	1/5	1/20	1/1 3/4	1/5	1/20	1/1 3/4	1/5	1/20	1/1 3/4	1/5	1/20	1/1 3/4	1/5	1/20	1/1 3/4	1/5	1/20		
								235	275	360	245	285	375	230	265	345	220	255	335	210	245	320
								200	235	310	210	245	320	200	230	300	190	220	290	180	210	275
								190	220	290	200	230	300	185	215	280	180	205	270	170	200	260
								165	195	255	175	200	260	165	190	250	155	180	235	150	175	230
								155	180	235	160	190	250	150	175	230	145	170	225	140	160	210
								200	235	310	210	245	320	200	230	300	190	220	290	180	210	275
								165	195	255	175	200	260	165	190	250	155	180	235	150	175	230
								155	180	235	160	190	250	150	175	230	145	170	225	140	160	210
								130	155	205	135	160	210	130	150	195	125	145	190	120	135	180
								120	140	185	125	145	190	115	135	180	110	130	170	105	125	165
								85	100	130	90	100	130	85	95	125	80	90	120	75	90	120
								120	140	180	125	145	190	115	135	175	110	130	170	105	125	160
								100	120	155	105	120	160	100	115	145	95	110	145	90	105	135
								125	150	195	130	155	200	125	145	185	120	140	180	115	130	170
								100	120	155	105	120	160	100	115	145	95	110	145	90	105	135
	300	345	450	260	300	390					270	315	410	255	295	385	245	285	375	235	275	360
	180	210	275	155	180	235					160	190	250	150	175	230	145	170	225	140	160	210
	210	245	320	180	210	275					185	215	280	175	200	260	165	195	255	160	185	245
	140	165	215	120	140	185					125	145	190	115	135	180	110	130	170	105	125	165
	250	290	380	215	250	325					225	260	340	210	240	315	200	230	300	190	225	295
	170	200	260	145	165	215					150	175	230	140	160	210	135	155	205	130	150	195

HC Coated carbide
 HT Uncoated carbide, main component (TiC) o. (TiN), cermet
 HC₁ Coated cermet
 HW Uncoated carbide, main component (WC)

A
Turning
B
Milling
C
Drilling
D
Technical Information
E
Index



Indexable milling – group 4 (BMR01/02/03/04, TMP01, CMZ01, CMA01, CMD01)

	Material group	Composition / structure / heat treatment		Brinell hardness HB	Machining group	Starting values for cutting speed v_c [m/min]						
						HC (PVD)						
						YBG212			YBG252			
						a_e / D			a_e / D			
1/1 3/4	1/5	1/20	1/1 3/4	1/5	1/20							
A Turning	P Unalloyed steel	approx. 0,15 % C	annealed	125	1	215	250	325	205	240	315	
		approx. 0,45 % C	annealed	190	2	185	215	280	175	205	270	
		approx. 0,45 % C	tempered	250	3	175	200	260	165	195	255	
		approx. 0,75 % C	annealed	270	4	155	175	230	145	170	225	
	P Unalloyed steel	approx. 0,75 % C	tempered	300	5	140	165	215	135	160	210	
		Low-alloyed steel	annealed	180	6	185	215	280	175	205	270	
			tempered	275	7	155	175	230	145	170	225	
			tempered	300	8	140	165	215	135	160	210	
	P Unalloyed steel	tempered	350	9	120	140	185	115	135	180		
		High-alloyed steel and high-alloyed tool steel	annealed	200	10	110	125	165	105	120	160	
hardened and tempered	325		11	80	90	120	75	85	115			
B Milling	M Stainless steel	ferritic/martensitic	annealed	200	12	110	125	165	105	120	160	
		martensitic	tempered	240	13	95	105	140	90	105	135	
		austenitic	quench hardened	180	14	115	135	175	110	130	170	
		austenitic-ferritic		230	15	95	105	140	90	105	135	
C Drilling	K Cast iron with spheroidal graphite	perlitic/ferritic		180	16	240	280	365	230	265	345	
		perlitic (martensitic)		260	17	140	165	215	135	160	210	
	K Cast iron with spheroidal graphite	ferritic		160	18	165	190	250	155	180	235	
		perlitic		250	19	110	125	165	105	120	160	
	K Cast iron with spheroidal graphite	ferritic		130	20	195	225	295	185	220	290	
		perlitic		230	21	130	150	195	125	145	190	
D Technical Information	N Aluminium wrought alloys	cannot be hardened		60	22							
		hardenable	hardened	100	23							
	N Cast aluminium alloys	$\leq 12\% \text{ Si}$, cannot be hardened		75	24							
		$\leq 12\% \text{ Si}$, hardenable	hardened	90	25							
		$> 12\% \text{ Si}$, cannot be hardened		130	26							
	N Copper and copper alloys (bronze/brass)	machining steel, PB > 1%		110	27							
		CuZn, CuSnZn		90	28							
		CuSn, Pb-free copper, electrolytic copper		100	29							
	S Heat-resistant alloys	Fe-based alloys	annealed	200	30							
			hardened	280	31							
Ni or Co bass		annealed	250	32								
		hardened	350	33								
		cast	320	34								
Titanium alloys	pure titanium	R_m 400	35									
	α and β alloys	hardened	R_m 1050	36								
H Hardened steel	Hardened steel	hardened and tempered	55 HRC	37								
		hardened and tempered	60 HRC	38								
	Hard cast iron	cast	400	39								
X Non-metallic materials	Hardened cast iron	hardened and tempered	55 HRC	40								
		Thermoplasts		41								
		Thermosetting plastics		42								
		Plastic, glass-fibre reinforced GFRP		43								
X Non-metallic materials	Plastic, carbon fibre reinforced CFRP		44									
	Graphite		45									
	Wood		46									

Note: The given cutting values are guide values, which were determined under ideal conditions.
 The values have to be adapted in individual cases.
 Feed rate recommendations on page B254.
 For examples of material for cutting tool groups view page D11.

Recommended feed rate

Indexable milling – group 3 (FMR01/02/03/04) Circular milling

Material group	Feed rate per cutting edge [mm]							
	FMR01	FMR01	FMR02	FMR02	FMR02	FMR03		
	RCKT10	RC*12	RC*12	RCKT16	RCKT20	RDKW07		
	Tool diameter [mm]							
	25-32	40-50	50-100	63-125	160-200	80-125	160-250	15
P Unalloyed steel	0,12	0,16	0,18	0,24	0,32	0,26	0,35	0,07
	0,11	0,14	0,16	0,21	0,28	0,23	0,31	0,06
	0,10	0,13	0,14	0,19	0,26	0,21	0,28	0,06
M Stainless steel	0,07	0,09	0,10	0,14	0,18	0,15	0,20	0,04
K Grey cast iron	0,11	0,14	0,16	0,22	0,29	0,23	0,32	0,06
	0,10	0,13	0,14	0,19	0,26	0,21	0,28	0,06
	0,10	0,13	0,14	0,19	0,26	0,21	0,28	0,06
N Aluminium wrought alloys								
S Heat-resistant alloys								
H Hardened steel								
X Non-metallic materials								

Note: The given cutting values are guide values, which were determined under ideal conditions.
The values have to be adapted in individual cases.

Indexable milling – group 4 (BMR01/02/03/04, TMP01, CMZ01, CMA01, CMD01)

Material group	Feed rate per cutting edge [mm]								
	BMR01	BMR01	BMR01	BMR01	BMR02	BMR02	BMR02	BMR03	BMR03
	ZD*08 / SP*06	ZD*11 / SP*06	ZD*13 / SP*09	ZP*22 / SP*12	ROHX12	ROHX16	ROHX20	-	-
	Tool diameter [mm]								
	20	25	32	40-63	12	16	20	16	20
P Unalloyed steel	0,14	0,21	0,26	0,32	0,10	0,13	0,14	0,13	0,14
	0,10	0,15	0,18	0,22	0,07	0,09	0,10	0,09	0,10
	0,09	0,14	0,17	0,21	0,07	0,08	0,09	0,08	0,09
M Stainless steel	0,08	0,12	0,14	0,18	0,06	0,07	0,08	0,07	0,08
K Grey cast iron	0,18	0,27	0,34	0,42	0,13	0,17	0,18	0,17	0,18
	0,13	0,20	0,25	0,30	0,10	0,12	0,13	0,12	0,13
	0,14	0,21	0,26	0,32	0,10	0,13	0,14	0,13	0,14
N Aluminium wrought alloys									
S Heat-resistant alloys									
H Hardened steel									
X Non-metallic materials									

Note: The given cutting values are guide values, which were determined under ideal conditions.
The values have to be adapted in individual cases.

Feed rate per cutting edge [mm]						
FMR03	FMR03	FMR04	FMR04	FMR04		
RDKW08	RD*10	RD*12	RDKW16	RDKW20		
Tool diameter [mm]						
16-25	32	50-63	80-100	125-160		
0,07	0,12	0,17	0,24	0,30		
0,06	0,11	0,15	0,21	0,26		
0,06	0,10	0,14	0,19	0,24		
0,04	0,07	0,10	0,14	0,17		
0,06	0,11	0,15	0,22	0,27		
0,06	0,10	0,14	0,19	0,24		
0,06	0,10	0,14	0,19	0,24		
	0,10	0,11				
	0,10	0,11				
	0,10	0,11				

Feed rate per cutting edge [mm]												
BMR03	BMR03	BMR03	BMR04	BMR04	BMR04	BMR04	BMR04	BMR04	CMZ01	CMA01	CMD01	
-	-	-	ZOHX12	ZOHX16	ZOHX20	ZOHX25	ZOHX30		SPMT12	SPMT12	SPMT12	
Tool diameter [mm]												
25	30-32	40-50	12	16	20	25	30	12-32	12-32	12-36		
0,21	0,26	0,30	0,10	0,13	0,14	0,16	0,17	0,23	0,23	0,23		
0,15	0,18	0,21	0,07	0,09	0,10	0,11	0,12	0,16	0,16	0,16		
0,14	0,17	0,20	0,07	0,08	0,09	0,10	0,11	0,15	0,15	0,15		
0,12	0,14	0,17	0,06	0,07	0,08	0,09	0,09	0,13	0,13	0,13		
0,27	0,34	0,39	0,13	0,17	0,18	0,21	0,22	0,30	0,30	0,30		
0,20	0,25	0,29	0,10	0,12	0,13	0,15	0,16	0,22	0,22	0,22		
0,21	0,26	0,30	0,10	0,13	0,14	0,16	0,17	0,23	0,23	0,23		

A

Turning

B

Milling

C

Drilling





D

Technical Information







E

Index

Square shoulder milling

Series	Milling body	Inserts	Kr	Application						Features	Page
				P	M	K	N	S	H		
EMP13		 ANGX1105 ANGX1506	90°	✓	✓	✓	✓			<ul style="list-style-type: none"> • Diameter range Ø50 – 80 mm • For steel, cast iron and non-ferrous metals • Double sided, thicker inserts for high stability and deeper cutting depths • Inserts with four cutting edges 	B129
EMP13		 ANGX1105 ANGX1506	90°	✓	✓	✓	✓			<ul style="list-style-type: none"> • Diameter range Ø25 – 40 mm • For steel, cast iron and non-ferrous metals • Double sided, thicker inserts for high stability and deeper cutting depths • Inserts with four cutting edges 	B131

Profile milling

BMR01		 ZDET08T2 & SPMT0603 ZDET1103 & SPMT0603 ZDET13T2 & SDMT0903 ZPNT2204 & SPMT1204		✓	✓	✓				<ul style="list-style-type: none"> • Diameter range Ø20 – 63 mm • For steel, stainless steel and cast iron • Very suitable for roughing of big moulds • Inserts with three cutting edges 	B133
BMR02		 ROHX1203 ROHX1604 ROHX2005		✓	✓	✓				<ul style="list-style-type: none"> • Diameter range Ø12 – 20 mm • For steel, stainless steel and cast iron • Very suitable for finishing in mould and die industry • Inserts with two cutting edges 	B136
BMR03		 XPHT16 XPHT20 XPHT25 XPHT30 XPHT32 XPHT40		✓	✓	✓				<ul style="list-style-type: none"> • Diameter range Ø16 – 40 mm • For steel and cast iron • Very suitable for roughing in mould and die industry • Tool with high stability 	B138

✓ Very suitable ✓ Suitable

A

Turning

B

Milling

C

Drilling



D

Technical Information

E

Index

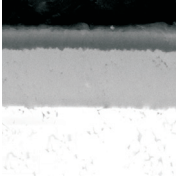
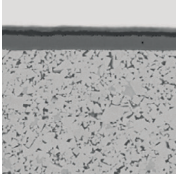
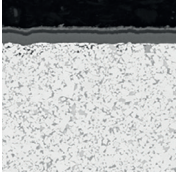
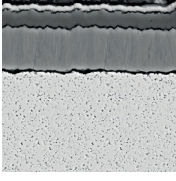
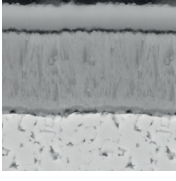
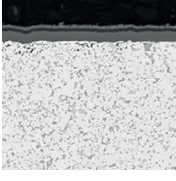
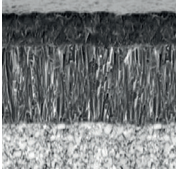
Coated cemented carbide CVD

Grade	ISO	Micro structure	Grade description
YBC302	P20 - P35		CVD coated P20-P35 carbide grade for medium operation to roughing of steel at higher cutting speed. Optimal performance of wear resistance and toughness for a wide application field.
YBC301	P20 - P35		CVD coated P20-P35 carbide grade for medium operation to roughing of steel at lower cutting speed.
YBC401	P30 - P50 M30 - M40		CVD coated P30-P50/M30-M40 carbide grade for roughing operation of steel at lower cutting speed and unstable condition.
YBM251	P20 - P30 M15 - M35		CVD coated P20-P30/M15-M35 carbide grade for medium to roughing operation in stainless steel and steel with wide application field. Good wear resistance and capability against plastic deformation at normal cutting speed.
YBM253	M15 - M35		CVD coated M15-M35 carbide grade for medium to roughing operation in stainless steel with wide application field. High wear resistance and capability against plastic deformation at higher cutting speed.
YBM351	P25 - P40 M20 - M40		CVD coated P25-P40/M25-M40 carbide grade for roughing operation in stainless steel and steel. Good wear resistance and edge stability at normal cutting speed.
YBD152	K10 - K25		CVD coated K10-K25 carbide substrate. Optimized for medium to roughing operation of cast iron. Good wear resistance and toughness at higher cutting speed.
YBD252	K20 - K35		CVD coated K20-K35 carbide substrate. Optimized for medium to roughing operation of cast iron and Steel. Good wear resistance and toughness at higher cutting speed.

A

Turning

B

Milling

C

Drilling

DTechnical
Information**E**

Index

Coated cemented carbide PVD

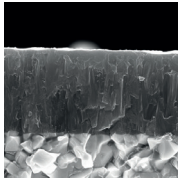
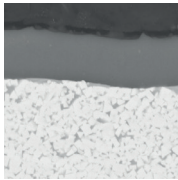
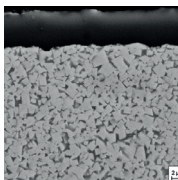
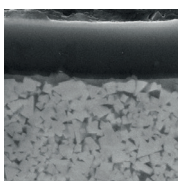
Grade	ISO	Micro structure	Grade description
A Turning	YBG101	N05–N20	 <p>PVD coated N05–N20 carbide substrate for finishing to semi-finishing in aluminium materials. Coating only on the top face, in combination with the aluminium chip breakers, prevents built-up edges and gives a smooth cut.</p>
B Milling	YBG202	P10 - P30 M10-M25	 <p>PVD coated P10–P30/M10–M25 carbide substrate for finishing to medium application of stainless steel and steel (milling). Good wear resistance in a wide application field.</p>
D Technical Information	YBS203	S15 – S25	 <p>Turning and milling grades for processing heat-resistant materials. A special carbon substrate and the latest PVD coating technology enable a very good wear behaviour, high fracture toughness and high thermal stability.</p>
YBG302	P15 - P30 M25 - M40	 <p>PVD multilayer coated P10–P30/M10–M25 carbide substrate for finishing to medium machining of stainless steel, super alloys and steel (grooving/milling). Optimised coating stability for higher wear resistance and thermal stability in a wide range of applications.</p>	
			YBG302

Coated cemented carbide PVD

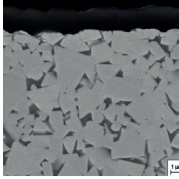
Grade	ISO	Micro structure	Grade description
YBS303	S25 - S35		Milling grade for machining titanium alloys. A tough carbide substrate and the latest PVD coating technology with increased impact resistance and high thermal stability.

Cermet

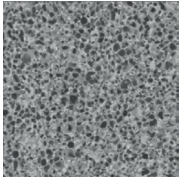
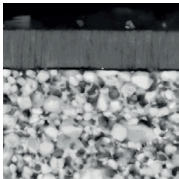
Grade	ISO	Micro structure	Grade description
YNG151	P05 - P15		Uncoated P05-P15 cermet grade for fine finishing operation of steel and stainless steel. Good resistance against plastic deformation for good surface finishing.
YNG151C	P05 - P15		PVD coated P05-P15 cermet grade for fine finishing operation of steel and stainless steel. Good wear resistance and capability against plastic deformation for good surface roughness.

Uncoated cemented carbide

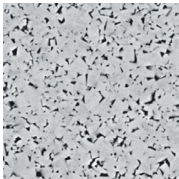
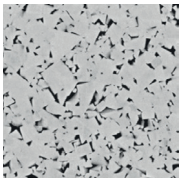
Grade	ISO	Micro structure	Grade description
YD101	N05 - N25 K05 - K20		Uncoated K05-K20/N05-N20 carbide substrate for fine to medium application in aluminum and other material.
YD201	K10 - K30 N10 - N30		Uncoated K10-K30/N10-N30 carbide substrate for medium application in aluminum and other material.

A

Turning

B

Milling

C

Drilling

DTechnical
Information**E**

Index

Application fields of grades – indexable milling

	ISO	HC ¹ (CVD)	HC ¹ (PVD)	HT	HC ²	HW	PCBN/PCD
P	P01		YBG102		YNG151C		
	P10		YBG202	YNG151			
	P20	YBC301	YBG205		YNG151C		
	P30	YBC401	YBG302			YC305	
	P40	YBM351	YB9320				
M	M01		YBG102		YNG151C		
	M10	YBM251	YBG202	YNG151			
	M20	YBM253	YBG205		YNG151C		
	M30	YBM351	YBG302			YC305	
	M40	YBC401	YB9320				
K	K01		YBG102				
	K10	YBD152	YBG152				
	K20	YBD252	YBG202			YD201	
	K30						
	K40						
N	N01					YD051	
	N10		YBG101			YD101	
	N20		YBG202				YD201
	N30						
S	S01		YBG102				
	S10		YBG202				
	S20		YBG205				
	S30		YBS203				
			YBS303				
H	H01		YBG102				
	H10						
	H20						
	H30						

P	Steel
M	Stainless steel
K	Cast iron

N	Non-ferrous metals
S	Heat-resistant alloys
H	Hardened materials

HC ¹	Coated carbide
HT	Uncoated cermet
HC ²	Coated carbide
HW	Uncoated carbide