



I-DREAM DRILL INSERTS & HOLDERS

i-DREAM DRILL EINSÄTZE UND HALTER

PLAQUETTES ET PORTE-PLAQUETTE I-DREAM DRILL - USAGE GÉNÉRAL / INOX

INSERTI & PORTAINSERTI I-DREAM DRILL

- Features of i-Dream Drill Inserts- - Merkmale des i-Dream Drill Einsätze

- ▶ Secure and accurate seating resulting in accurate repeatability and concentricity.
Der sichere und genaue Sitz der Platte garantiert genaue Wiederholbarkeit beim Einsatz und beim Rundlauf.
- i-Dream Drill General / i-Dream Drill allgemeinen**
- ▶ For most steels materials / In den meisten Stahlsorten
i-Dream Drill INOX / i-Dream Drill INOX
- ▶ For tough, ductile materials and stainless steels
Für zähe, verformbare Werkstoffe und rostfreie Stähle.
- ▶ Light, sharp cutting edge / Scharfe Schneidkante
- ▶ Soft cutting action / Weicher Schnitt
- ▶ Minimize cutting forces / Minimaler Schneidendruck
- ▶ Reduce built-up edge / Reduzierte Gratbildung

- Features of i-Dream Drill Holders- - Merkmale des i-Dream Drill Halter-

- ▶ Special Alloy Steels maintain its hardness and toughness under high temperatures.
Speziell legierter Stahl, der seine Härte und Zähigkeit auch bei hohen Temperaturen behält.
- ▶ Innovative surface treatment improves wear resistance and reduces corrosion.
Innovative Oberflächenbehandlung, die die Verschleissfestigkeit erhöht und die Korrosion vermindert.
- ▶ High Performance flute design allows maximum chip evacuation and minimum interference.
Optimierte Nutenform für maximale Spanabfuhr.



Recommended ToolHolder	Flat Shank	Page	Plain Shank	Page
	INDEXABLE DRILL HOLDER	D245-246	-	-
	ER COLLET CHUCK		D73-115	

Unit : mm

Series Range	Insert EDP No.		Insert O.D.			Holder EDP No.	Shank Dia. SD	Shank Length L2	Flange Dia. FD	Drilling Depth L1	Overall Length L3 Ref.	Screw No.	
	General (TiAlN)	INOX (TiCN)	h7										
			dec.	frac.	mm								
A Ø12.00 to Ø13.99	YA1A1200	YA2C1200	.4724	-	12.00	ZH12003020				3D	36	112.4	TX1213T08
	YA1A1210	YA2C1210	.4764	-	12.10	ZH12005020	20	50	25	5D	60	136.4	
	YA1A1220	YA2C1220	.4803	-	12.20	ZH12007020				7D	84	160.4	
	YA1A1230	YA2C1230	.4844	31/64	12.30	ZH12503020				3D	37.5	113.4	
	YA1A1250	YA2C1250	.4921	-	12.50	ZH12505020	20	50	25	5D	62.5	138.4	
	YA1A1260	YA2C1260	.4961	-	12.60	ZH12507020				7D	87.5	163.4	
	YA1A1270	YA2C1270	.5000	1/2	12.70	ZH13003020				3D	39	115.4	TX1314T08
	YA1A1280	YA2C1280	.5039	-	12.80	ZH13005020	20	50	25	5D	65	141.4	
	YA1A1290	YA2C1290	.5079	-	12.90	ZH13007020				7D	91	167.4	
	YA1A1300	YA2C1300	.5118	-	13.00	ZH13503020				3D	40.5	116.4	
	YA1A1310	YA2C1310	.5156	33/64	13.10	ZH13505020	20	50	25	5D	67.5	143.4	
	YA1A1320	YA2C1320	.5197	-	13.20	ZH13507020				7D	94.5	170.4	
	YA1A1349	YA2C1349	.5312	17/32	13.49								
	YA1A1350	YA2C1350	.5315	-	13.50								
	YA1A1360	YA2C1360	.5354	-	13.60								
	YA1A1370	YA2C1370	.5394	-	13.70								
	YA1A1380	YA2C1380	.5433	-	13.80								
	YA1A1389	YA2C1389	.5469	35/64	13.89								

▶ Other diameters of insert and shank types of holder are available upon request.

◎ : Excellent ○ : Good

ISO	P										M				K								
	Non-alloy steel					Low alloy steel					High alloyed steel, and tool steel				Stainless steel				Grey cast iron		Nodular cast iron		Malleable cast iron
VDI 3323	1	2	3	4	5	6	7	8	9	10	11	12	13	14	15	16	17	18	19	20			
HRc		13	25	28	32	10	29	32	38	38	15	35	15	23	10	10	26	3	25	21			
HB	125	190	250	270	300	180	275	300	350	200	200	325	200	240	180	180	260	160	250	130	230		
YA1A	◎	◎	◎	◎	◎	◎	◎	◎	◎	◎	◎	◎	◎	◎	◎	◎	◎	◎	◎	◎	◎		
YA2C	○	○	○	○	○	○	○	○	○	○	○	○	○	○	○	○	○	○	○	○	○		

ISO	N										S							H			
	Aluminum-wrought alloy		Aluminum-cast, alloyed			Copper and Copper Alloys (Bronze / Brass)					Non Metallic Materials		Heat Resistant Super Alloys					Titanium Alloys		Hardened steel	Chilled Cast Iron
VDI 3323	21	22	23	24	25	26	27	28	29	30	31	32	33	34	35	36	37	38	39	40	41
HRc											15	30	25	38	34			55	60	42	55
HB	60	100	75	90	130	110	90	100			200	280	250	350	320	400Rm	1050Rm	550	630	400	550
YA1A																					
YA2C	○	○	○	○	○	○	○	○	○	○											

I-DREAM DRILL INSERTS & HOLDERS

i-DREAM DRILL EINSÄTZE UND HALTER
PLAQUETTES ET PORTE-PLAQUETTE I-DREAM DRILL - USAGE GÉNÉRAL / INOX
INSERTI & PORTAINSERTI I-DREAM DRILL
- Features of i-Dream Drill Inserts-
Merkmale des i-Dream Drill Einsätze

- ▶ Secure and accurate seating resulting in accurate repeatability and concentricity.

Der sichere und genaue Sitz der Platte garantiert genaue Wiederholbarkeit beim Einsatz und beim Rundlauf.

i-Dream Drill General / i-Dream Drill allgemeinen

- ▶ For most steels materials / In den meisten Stahlsorten

i-Dream Drill INOX / i-Dream Drill INOX

- ▶ For tough, ductile materials and stainless steels

Für zähe, verformbare Werkstoffe und rostfreie Stähle.

- ▶ Light, sharp cutting edge / Scharfe Schneidkante
- ▶ Soft cutting action / Weicher Schnitt
- ▶ Minimize cutting forces / Minimaler Schneidendruck
- ▶ Reduce built-up edge / Reduzierte Gratbildung

- Features of i-Dream Drill Holders-
- Merkmale des i-Dream Drill Halters-

- ▶ Special Alloy Steels maintain its hardness and toughness under high temperatures.

Speziell legierter Stahl, der seine Härte und Zähigkeit auch bei hohen Temperaturen behält.

- ▶ Innovative surface treatment improves wear resistance and reduces corrosion.

Innovative Oberflächenbehandlung, die die Verschleissfestigkeit erhöht und die Korrosion vermindert.

- ▶ High Performance flute design allows maximum chip evacuation and minimum interference.

Optimierte Nutenform für maximale Spanabfuhr.



Unit : mm

Series Range (mm)	Insert EDP No.		Insert O.D.			Holder EDP No.	Shank Dia. SD	Shank Length L2	Flange Dia. FD	Drilling Depth		Overall Length L3 Ref.	Screw No.
	General (TiAlN)	INOX (TiCN)	h7							L1	L3 Ref.		
			dec.	frac.	mm								
B Ø14.00 to Ø15.99	YB1A1400	YB2C1400	.5512	-	14.00	ZH14003020				3D	42	118.9	TX1415T08
	YB1A1410	YB2C1410	.5551	-	14.10								
	YB1A1420	YB2C1420	.5591	-	14.20	ZH14005020	20	50	25	5D	70	146.9	
	YB1A1429	YB2C1429	.5625	9/16	14.29								
	YB1A1430	YB2C1430	.5630	-	14.30	ZH14007020				7D	98	174.9	
	YB1A1440	YB2C1440	.5669	-	14.40								
	YB1A1450	YB2C1450	.5709	-	14.50	ZH14503020				3D	43.5	120.9	TX1516T08
	YB1A1460	YB2C1460	.5748	-	14.60								
	YB1A1468	YB2C1468	.5781	37/64	14.68	ZH14505020	20	50	25	5D	72.5	149.9	
	YB1A1480	YB2C1480	.5827	-	14.80	ZH14507020				7D	101.5	178.9	
	YB1A1500	YB2C1500	.5906	-	15.00	ZH15003020				3D	45	122.9	
	YB1A1508	YB2C1508	.5938	19/32	15.08								
	YB1A1510	YB2C1510	.5945	-	15.10	ZH15005020	20	50	25	5D	75	152.9	
	YB1A1520	YB2C1520	.5984	-	15.20								
	YB1A1530	YB2C1530	.6024	-	15.30	ZH15007020				7D	105	182.9	
	YB1A1548	YB2C1548	.6094	39/64	15.48								
	YB1A1550	YB2C1550	.6102	-	15.50	ZH15503020				3D	46.5	123.9	
	YB1A1560	YB2C1560	.6142	-	15.60								
	YB1A1570	YB2C1570	.6181	-	15.70	ZH15505020	20	50	25	5D	77.5	154.9	
	YB1A1580	YB2C1580	.6220	-	15.80								
YB1A1587	YB2C1587	.6250	5/8	15.87	ZH15507020				7D	108.5	185.9		

▶ Other diameters of insert and shank types of holder are available upon request.

◎ : Excellent ○ : Good

ISO Material Description	P									M				K						
	Non-alloy steel					Low alloy steel				High alloyed steel, and tool steel	Stainless steel			Grey cast iron		Nodular cast iron		Malleable cast iron		
VDI 3323	1	2	3	4	5	6	7	8	9	10	11	12	13	14	15	16	17	18	19	20
HRC	13	25	28	32	30	10	29	32	38	15	35	15	23	10	10	26	3	25		
HB	125	190	250	270	300	180	275	300	350	200	325	200	240	180	180	260	160	250	130	230
YB1A	◎	◎	◎	◎	◎	◎	◎	◎	◎	◎	◎	◎	◎	◎	◎	◎	◎	◎	◎	◎
YB2C	○	○	○	○	○	○	○	○	○	○	○	◎	◎	◎						

ISO Material Description	N									S							H				
	Aluminum-wrought alloy			Aluminum-cast, alloyed			Copper and Copper Alloys (Bronze / Brass)			Non Metallic Materials	Heat Resistant Super Alloys				Titanium Alloys			Hardened steel	Chilled Cast Iron	Hardened Cast Iron	
VDI 3323	21	22	23	24	25	26	27	28	29	30	31	32	33	34	35	36	37	38	39	40	41
HRC											15	30	25	38	34			55	60	42	55
HB	60	100	75	90	130	110	90	100			200	280	250	350	320	400Rm	1050Rm	550	630	400	550
YB1A																					
YB2C	○	○	○	○	○	○	○	○	○												

I-DREAM DRILL INSERTS & HOLDERS

i-DREAM DRILL EINSÄTZE UND HALTER

PLAQUETTES ET PORTE-PLAQUETTE I-DREAM DRILL - USAGE GÉNÉRAL / INOX
INSERTI & PORTAINSERTI I-DREAM DRILL

**- Features of i-Dream Drill Inserts-
 Merkmale des i-Dream Drill Einsätze**

- ▶ Secure and accurate seating resulting in accurate repeatability and concentricity.
 Der sichere und genaue Sitz der Platte garantiert genaue Wiederholbarkeit beim Einsatz und beim Rundlauf.
- i-Dream Drill General / i-Dream Drill allgemeinen**
- ▶ For most steels materials / In den meisten Stahlsorten
i-Dream Drill INOX / i-Dream Drill INOX
- ▶ For tough, ductile materials and stainless steels
 Für zähe, verformbare Werkstoffe und rostfreie Stähle.
- ▶ Light, sharp cutting edge / Scharfe Schneidkante
- ▶ Soft cutting action / Weicher Schnitt
- ▶ Minimize cutting forces / Minimaler Schneidendruck
- ▶ Reduce built-up edge / Reduzierte Gratbildung

**- Features of i-Dream Drill Holders-
 - Merkmale des i-Dream Drill Halter-**

- ▶ Special Alloy Steels maintain its hardness and toughness under high temperatures.
 Speziell legierter Stahl, der seine Härte und Zähigkeit auch bei hohen Temperaturen behält.
- ▶ Innovative surface treatment improves wear resistance and reduces corrosion.
 Innovative Oberflächenbehandlung, die die Verschleissfestigkeit erhöht und die Korrosion vermindert.
- ▶ High Performance flute design allows maximum chip evacuation and minimum interference.
 Optimierte Nutenform für maximale Spanabfuhr.



CARBIDE
ISO 9766
h7
140°
TiAlN
TiCN
p.A54, 55
Recommended ToolHolder

Flat Shank	Page	Plain Shank	Page
INDEXABLE DRILL HOLDER	D245-246	-	-
ER COLLET CHUCK		D73-115	

Unit : mm

Series Range (mm)	Insert EDP No.		Insert O.D.			Holder EDP No.	Shank Dia. SD	Shank Length L2	Flange Dia. FD	Drilling Depth		Overall Length L3 Ref.	Screw No.
	General (TiAlN)	INOX (TiCN)	dec.	frac.	mm					L1	L3 Ref.		
C Ø16.00 to Ø17.99	YC1A1600	YC2C1600	.6299	-	16.00	ZH16003020				3D	48	125.0	TX1617T08
	YC1A1609	YC2C1609	.6335	-	16.09	ZH16005020	20	50	25	5D	80	157.0	
	YC1A1620	YC2C1620	.6378	-	16.20					7D	112	189.0	
	YC1A1627	YC2C1627	.6406	41/64	16.27	ZH16503020	20	50	25	3D	49.5	127.0	
	YC1A1630	YC2C1630	.6417	-	16.30					5D	82.5	160.0	
	YC1A1650	YC2C1650	.6496	-	16.50	ZH16507020	20	50	25	7D	115.5	193.0	
	YC1A1667	YC2C1667	.6562	21/32	16.67	ZH17003020				20	50	25	3D
	YC1A1680	YC2C1680	.6614	-	16.80	ZH17005020	20	50	25				5D
	YC1A1700	YC2C1700	.6693	-	17.00	ZH17007020				20	50	25	7D
	YC1A1707	YC2C1707	.6719	43/64	17.07	ZH17503020	20	50	25				3D
	YC1A1746	YC2C1746	.6875	11/16	17.46	ZH17505020				20	50	25	5D
	YC1A1750	YC2C1750	.6890	-	17.50	ZH17507020	20	50	25				7D
	YC1A1780	YC2C1780	.7008	-	17.80								
	YC1A1786	YC2C1786	.7031	45/64	17.86								

▶ Other diameters of insert and shank types of holder are available upon request.

◎ : Excellent ○ : Good

ISO Material Description	P									M						K					
	Non-alloy steel					Low alloy steel				High alloyed steel, and tool steel		Stainless steel				Grey cast iron		Nodular cast iron		Malleable cast iron	
VDI 3323	1	2	3	4	5	6	7	8	9	10	11	12	13	14	15	16	17	18	19	20	
HRc		13	25	28	32	10	29	32	38	15	35	15	23	10	10	26	3	25		21	
HB	125	190	250	270	300	180	275	300	350	200	325	200	240	180	180	260	160	250	130	230	
YC1A	◎	◎	◎	◎	◎	◎	◎	◎	◎	◎	◎	◎	◎	◎	◎	◎	◎	◎	◎	◎	
YC2C	○	○	○	○	○	○	○	○	○	○	○	◎	◎	◎							

ISO Material Description	N										S							H					
	Aluminum-wrought alloy					Aluminum-cast, alloyed					Copper and Copper Alloys (Bronze / Brass)		Non Metallic Materials		Heat Resistant Super Alloys					Titanium Alloys		Hardened steel	Chilled Cast Iron
VDI 3323	21	22	23	24	25	26	27	28	29	30	31	32	33	34	35	36	37	38	39	40	41		
HRc											15	30	25	38	34			55	60	42	55		
HB	60	100	75	90	130	110	90	100			200	280	250	350	320	400Rm	1050Rm	550	630	400	550		
YC1A																							
YC2C	○	○	○	○	○	○	○	○	○	○													

I-DREAM DRILL INSERTS & HOLDERS
● i-DREAM DRILL EINSÄTZE UND HALTER
● PLAQUETTES ET PORTE-PLAQUETTE I-DREAM DRILL - USAGE GÉNÉRAL / INOX
● INSERTI & PORTAINSERTI i-DREAM DRILL
- Features of i-Dream Drill Inserts-
Merkmale des i-Dream Drill Einsätze

- ▶ Secure and accurate seating resulting in accurate repeatability and concentricity.

Der sichere und genaue Sitz der Platte garantiert genaue Wiederholbarkeit beim Einsatz und beim Rundlauf.

i-Dream Drill General / i-Dream Drill allgemeinen

- ▶ For most steels materials / In den meisten Stahlsorten

i-Dream Drill INOX / i-Dream Drill INOX

- ▶ For tough, ductile materials and stainless steels

Für zähe, verformbare Werkstoffe und rostfreie Stähle.

- ▶ Light, sharp cutting edge / Scharfe Schneidkante
- ▶ Soft cutting action / Weicher Schnitt
- ▶ Minimize cutting forces / Minimaler Schneidendruck
- ▶ Reduce built-up edge / Reduzierte Gratbildung

- Features of i-Dream Drill Holders-
- Merkmale des i-Dream Drill Halters-

- ▶ Special Alloy Steels maintain its hardness and toughness under high temperatures.

Speziell legierter Stahl, der seine Härte und Zähigkeit auch bei hohen Temperaturen behält.

- ▶ Innovative surface treatment improves wear resistance and reduces corrosion.

Innovative Oberflächenbehandlung, die die Verschleissfestigkeit erhöht und die Korrosion vermindert.

- ▶ High Performance flute design allows maximum chip evacuation and minimum interference.

Optimierte Nutenform für maximale Spanabfuhr.



Unit : mm

Series Range (mm)	Insert EDP No.		Insert O.D.			Holder EDP No.	Shank Dia. SD	Shank Length L2	Flange Dia. FD	Drilling Depth		Overall Length L3 Ref.	Screw No.	
	General (TiAlN)	INOX (TiCN)	h7							L1	L3 Ref.			
			dec.	frac.	mm									
D Ø18.00 to Ø19.99	YD1A1800	YD2C1800	.7087	-	18.00	ZH18003025	25	56	32	3D	54	140.3	TX1819T15	
	YD1A1826	YD2C1826	.7188	23/32	18.26	ZH18005025				5D	90	176.3		
	YD1A1850	YD2C1850	.7283	-	18.50	ZH18007025				7D	126	212.3		
	YD1A1865	YD2C1865	.7344	47/64	18.65	ZH18503025	25	56	32	3D	55.5	141.3		
	YD1A1880	YD2C1880	.7402	-	18.80	ZH18505025				5D	92.5	178.3		
	YD1A1900	YD2C1900	.7480	-	19.00	ZH18507025				7D	129.5	215.3		
	YD1A1905	YD2C1905	.7500	3/4	19.05	ZH19003025	25	56	32	3D	57	144.3		
	YD1A1927	YD2C1927	.7587	-	19.27	ZH19005025				5D	95	182.3		
	YD1A1945	YD2C1945	.7656	49/64	19.45	ZH19007025				7D	133	220.3		
	YD1A1950	YD2C1950	.7677	-	19.50	ZH19503025	25	56	32	3D	58.5	145.3		TX1920T15
	YD1A1980	YD2C1980	.7795	-	19.80	ZH19505025				5D	97.5	184.3		
	YD1A1984	YD2C1984	.7812	25/32	19.84	ZH19507025				7D	136.5	223.3		

▶ Other diameters of insert and shank types of holder are available upon request.

◎ : Excellent ○ : Good

ISO Material Description	P									M				K					
	Non-alloy steel					Low alloy steel				High alloyed steel, and tool steel	Stainless steel			Grey cast iron	Nodular cast iron		Malleable cast iron		
VDI 3323	1	2	3	4	5	6	7	8	9	10	12	13	14	15	16	17	18	19	20
HRC		13	25	28	32	10	29	32	38	15	35	23	10	10	26	3	25		21
HB	125	190	250	270	300	180	275	300	350	200	325	200	180	180	260	160	250	130	230
YD1A	◎	◎	◎	◎	◎	◎	◎	◎	◎	◎	◎	◎	◎	◎	◎	◎	◎	◎	◎
YD2C	○	○	○	○	○	○	○	○	○	○	○	○	○	○	○	○	○	○	○

ISO Material Description	N					S							H								
	Aluminum-wrought alloy		Aluminum-cast, alloyed			Copper and Copper Alloys (Bronze / Brass)			Non Metallic Materials		Heat Resistant Super Alloys				Titanium Alloys		Hardened steel	Chilled Cast Iron	Hardened Cast Iron		
VDI 3323	21	22	23	24	25	26	27	28	29	30	31	32	33	34	35	36	37	38	39	40	41
HRC											15	30	25	38	34			55	60	42	55
HB	60	100	75	90	130	110	90	100			200	280	250	350	320	400Rm	1050Rm	550	630	400	550
YD1A																					
YD2C	○	○	○	○	○	○	○	○													

Stable Insert locking System

- V type locking system allowed for stabilized drilling
- Design that fastening screw doesn't touch insert to protect the insert locking system from the vibration during the drilling cycle

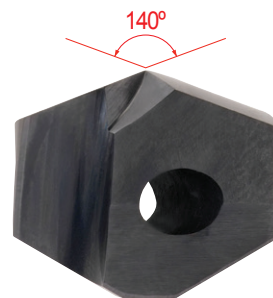
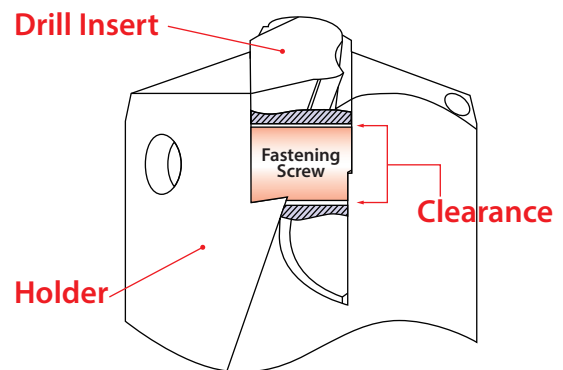
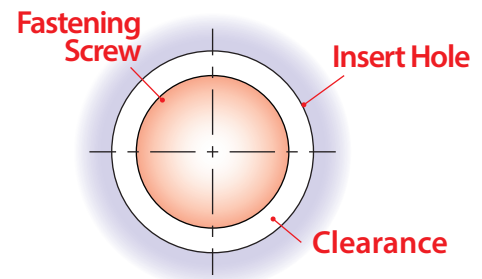
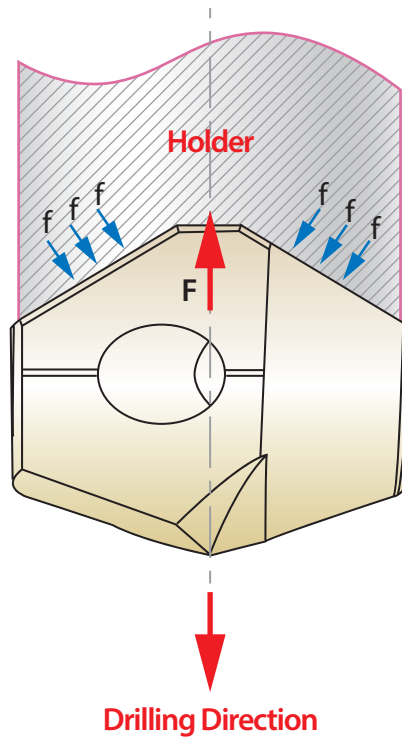

Self-Centering 140° Point & Helical Thinning

- Excellent Centering
- Minimized cutting resistance
- Design for maximum toughness, hardness and chip evacuation
- High penetration rate
- Reduced heat from cutting edge processing to allow long tool life
- Lower required torque and horsepower

SELECTION GUIDE



SERIES	YA1A	YA2C	YB1A	YB2C
TYPE	A		B	
SIZE MIN	12.00		14.00	
SIZE MAX	13.89		15.87	
PAGE	A44		A45	

SURFACE TREATMENT	TiAIN	TiCN	TiAIN	TiCN
-------------------	-------	------	-------	------

CARBIDE INSERTS & HOLDERS

i-DREAM DRILLS

For General Steels and Stainless Steels



Please visit globalyg1.com/mat for material search

◎ : Excellent ○ : Good

Recommended cutting conditions : p.A54, 55

ISO	VDI 3323	Material Description	Composition / Structure / Heat Treatment		HB	HRc	TiAIN	TiCN	TiAIN	TiCN
P	1	Non-alloy steel	About 0.15% C	Annealed	125		◎	○	◎	○
	2		About 0.45% C	Annealed	190	13	◎	○	◎	○
	3		About 0.45% C	Quenched & Tempered	250	25	◎	○	◎	○
	4		About 0.75% C	Annealed	270	28	◎	○	◎	○
	5	Low alloy steel	About 0.75% C	Quenched & Tempered	300	32	◎		◎	
	6		Annealed	180	10	◎	○	◎	○	
	7		Quenched & Tempered	275	29	◎	○	◎	○	
	8		Quenched & Tempered	300	32	◎		◎		
	9		Quenched & Tempered	350	38	◎		◎		
	10		High alloyed steel, and tool steel	Annealed	200	15	◎	○	◎	○
	11			Quenched & Tempered	325	35	◎		◎	
M	12	Stainless steel	Ferritic / Martensitic	Annealed	200	15		◎		◎
	13		Martensitic	Quenched & Tempered	240	23		◎		◎
	14		Austenitic	180	10		◎		◎	
K	15	Grey cast iron	Pearlitic / ferritic		180	10	◎		◎	
	16		Pearlitic (Martensitic)		260	26	◎		◎	
	17	Nodular cast iron	Ferritic		160	3	◎		◎	
	18		Pearlitic		250	25	◎		◎	
	19		Ferritic		130		◎		◎	
20	Malleable cast iron	Pearlitic		230	21	◎		◎		
N	21	Aluminum-wrought alloy	Not Curable		60			○		○
	22		Curable Hardened		100			○		○
	23	Aluminum-cast, alloyed	≤ 12% Si, Not Curable		75			○		○
	24		≤ 12% Si, Curable Hardened		90			○		○
	25		> 12% Si, Not Curable		130			○		○
	26	Copper and Copper Alloys (Bronze / Brass)	Cutting Alloys, PB>1%		110			○		○
	27		CuZn, CuSnZn (Brass)		90			○		○
	28		CuSn, lead-free copper and electrolytic copper		100			○		○
	29		Non Metallic Materials							
	30	Rubber, Wood, etc.								
S	31	Heat Resistant Super Alloys	Fe Based	Annealed	200	15				
	32			Cured	280	30				
	33		Ni or Co Based	Annealed	250	25				
	34			Cured	350	38				
	35			Cast	320	34				
	36			Pure Titanium	400 Rm					
37	Alpha + Beta Alloys	Hardened	1050 Rm							
H	38	Hardened steel	Hardened		550	55				
	39		Hardened		630	60				
	40		Cast		400	42				
	41		Hardened		550	55				

YC1A	YC2C	YD1A	YD2C	YE1A	YE2C	YF1A	YF2C	YG1A	YG2C
C		D		E		F		G	
16.00		18.00		20.00		22.00		24.00	
17.86		19.84		21.83		23.81		25.80	
A46		A47		A48		A49		A50	
TiAIN	TiCN	TiAIN	TiCN	TiAIN	TiCN	TiAIN	TiCN	TiAIN	TiCN



◎	○	◎	○	◎	○	◎	○	◎	○	1
◎	○	◎	○	◎	○	◎	○	◎	○	2
◎	○	◎	○	◎	○	◎	○	◎	○	3
◎	○	◎	○	◎	○	◎	○	◎	○	4
◎	○	◎	○	◎	○	◎	○	◎	○	5
◎	○	◎	○	◎	○	◎	○	◎	○	6 P
◎	○	◎	○	◎	○	◎	○	◎	○	7
◎	○	◎	○	◎	○	◎	○	◎	○	8
◎	○	◎	○	◎	○	◎	○	◎	○	9
◎	○	◎	○	◎	○	◎	○	◎	○	10
◎	○	◎	○	◎	○	◎	○	◎	○	11
	◎		◎		◎		◎		◎	12
	◎		◎		◎		◎		◎	13 M
	◎		◎		◎		◎		◎	14
◎		◎		◎		◎		◎		15
◎		◎		◎		◎		◎		16
◎		◎		◎		◎		◎		17 K
◎		◎		◎		◎		◎		18
◎		◎		◎		◎		◎		19
◎		◎		◎		◎		◎		20
	○		○		○		○		○	21
	○		○		○		○		○	22
	○		○		○		○		○	23
	○		○		○		○		○	24
	○		○		○		○		○	25 N
	○		○		○		○		○	26
	○		○		○		○		○	27
	○		○		○		○		○	28
										29
										30
										31
										32
										33
										34 S
										35
										36
										37
										38
										39 H
										40
										41

HSS

i-ONE DRILLS

i-DREAM DRILLS

DREAM DRILLS -PRO

DREAM DRILLS -GENERAL

DREAM DRILLS -HIGH FEED

DREAM DRILLS -FLAT BOTTOM

DREAM DRILLS -INOX

DREAM DRILLS -ALU

DREAM DRILLS -MQL

DREAM DRILLS for HIGH HARDENED STEELS

GENERAL CARBIDE DRILLS

MULTI-1 DRILLS

HPD DRILLS

GOLD-P DRILLS

SUPER-GP DRILLS

STRAIGHT SHANK DRILLS

TAPER SHANK DRILLS

NC-SPOTTING DRILLS

CENTER DRILLS

SPADE DRILLS

REAMERS

COUNTER SINKS

COUNTER BORES

TECHNICAL DATA

SELECTION GUIDE



SERIES	YH1A	YH2C
TYPE	H	
SIZE MIN	26.00	
SIZE MAX	27.78	
PAGE	A51	
SURFACE TREATMENT	TiAlN	TiCN

CARBIDE INSERTS & HOLDERS

i-DREAM DRILLS

For General Steels and Stainless Steels



Please visit globalyg1.com/mat for material search

◎ : Excellent ○ : Good

Recommended cutting conditions : p.A54, 55

ISO	VDI 3323	Material Description	Composition / Structure / Heat Treatment	HB	HRc		
P	1	Non-alloy steel	About 0.15% C Annealed	125		◎	○
	2		About 0.45% C Annealed	190	13	◎	○
	3		About 0.45% C Quenched & Tempered	250	25	◎	○
	4		About 0.75% C Annealed	270	28	◎	○
	5	About 0.75% C Quenched & Tempered	300	32	◎		
	6	Low alloy steel	Annealed	180	10	◎	○
	7		Quenched & Tempered	275	29	◎	○
	8		Quenched & Tempered	300	32	◎	
	9		Quenched & Tempered	350	38	◎	
	10		High alloyed steel, and tool steel	Annealed	200	15	◎
	11	Quenched & Tempered		325	35	◎	
M	12	Stainless steel	Ferritic / Martensitic Annealed	200	15		◎
	13		Martensitic Quenched & Tempered	240	23		◎
	14		Austenitic	180	10		◎
K	15	Grey cast iron	Pearlitic / ferritic	180	10	◎	
	16		Pearlitic (Martensitic)	260	26	◎	
	17	Nodular cast iron	Ferritic	160	3	◎	
	18		Pearlitic	250	25	◎	
	19		Ferritic	130		◎	
20	Malleable cast iron	Pearlitic	230	21	◎		
N	21	Aluminum-wrought alloy	Not Curable	60			○
	22		Curable Hardened	100			○
	23	Aluminum-cast, alloyed	≤ 12% Si, Not Curable	75			○
	24		≤ 12% Si, Curable Hardened	90			○
	25		> 12% Si, Not Curable	130			○
	26	Copper and Copper Alloys (Bronze / Brass)	Cutting Alloys, PB>1%	110			○
	27		CuZn, CuSnZn (Brass)	90			○
	28		CuSn, lead-free copper and electrolytic copper	100			○
	29		Non Metallic Materials	Duroplastic, Fiber Reinforced Plastic			
30	Rubber, Wood, etc.						
S	31	Heat Resistant Super Alloys	Fe Based Annealed	200	15		
	32		Cured	280	30		
	33		Annealed	250	25		
	34		Ni or Co Based Cured	350	38		
	35		Cast	320	34		
	36		Titanium Alloys	Pure Titanium	400 Rm		
37	Alpha + Beta Alloys	Hardened	1050 Rm				
H	38	Hardened steel	Hardened	550	55		
	39		Hardened	630	60		
	40	Chilled Cast Iron	Cast	400	42		
	41	Hardened Cast Iron	Hardened	550	55		

Y11A	Y12C	YJ1A	YJ2C	ZH*3	ZH*5	ZH*7
I		J				
28.00		30.00				
29.77		31.75				
A52		A53				
TiAlN	TiCN	TiAlN	TiCN	3XD	5XD	7XD



⊙	○	⊙	○				1
⊙	○	⊙	○				2
⊙	○	⊙	○				3
⊙	○	⊙	○				4
⊙	○	⊙	○				5
⊙	○	⊙	○				6 P
⊙	○	⊙	○				7
⊙	○	⊙	○				8
⊙	○	⊙	○				9
⊙	○	⊙	○				10
⊙	○	⊙	○				11
	⊙		⊙				12
	⊙		⊙				13 M
	⊙		⊙				14
⊙		⊙					15
⊙		⊙					16
⊙		⊙					17 K
⊙		⊙					18
⊙		⊙					19
⊙		⊙					20
	○		○				21
	○		○				22
	○		○				23
	○		○				24
	○		○				25 N
	○		○				26
	○		○				27
	○		○				28
							29
							30
							31
							32
							33
							34 S
							35
							36
							37
							38
							39 H
							40
							41

HSS

i-ONE DRILLS

i-DREAM DRILLS

DREAM DRILLS -PRO

DREAM DRILLS -GENERAL

DREAM DRILLS -HIGH FEED

DREAM DRILLS -FLAT BOTTOM

DREAM DRILLS -INOX

DREAM DRILLS -ALU

DREAM DRILLS -MQL

DREAM DRILLS for HIGH HARDENED STEELS

GENERAL CARBIDE DRILLS

MULTI-1 DRILLS

HPD DRILLS

GOLD-P DRILLS

SUPER-GP DRILLS

STRAIGHT SHANK DRILLS

TAPER SHANK DRILLS

NC-SPOTTING DRILLS

CENTER DRILLS

SPADE DRILLS

REAMERS

COUNTER SINKS

COUNTER BORES

TECHNICAL DATA

YA1A, YB1A, YC1A, YD1A, YE1A, YF1A, YG1A, YH1A, YI1A, YJ1A SERIES

i-DREAM DRILLS - GENERAL

VC = M/MIN
RPM = rev./min.
FEED = mm/rev.

ISO	VDI 3323	Material Description	Vc (m/min)	Feed(mm/rev)					
				Ø12.00-14.99	Ø15.00-17.99	Ø18.00-21.99	Ø22.00-26.99	Ø27.00-31.99	
P	1	Non-alloy steel	95-120	0.16-0.28	0.21-0.35	0.27-0.40	0.34-0.52	0.37-0.55	
	2		80-105	0.14-0.24	0.21-0.35	0.27-0.40	0.34-0.52	0.37-0.55	
	3		60-80	0.12-0.20	0.17-0.28	0.22-0.32	0.30-0.46	0.33-0.49	
	4		55-70	0.10-0.16	0.15-0.25	0.21-0.30	0.25-0.38	0.29-0.43	
	5	Low alloy steel	55-70	0.10-0.16	0.15-0.25	0.21-0.30	0.25-0.38	0.29-0.43	
	6		70-90	0.12-0.20	0.17-0.28	0.22-0.32	0.30-0.46	0.34-0.50	
	7		60-80	0.12-0.20	0.15-0.25	0.22-0.32	0.30-0.46	0.34-0.50	
	8		55-70	0.10-0.16	0.13-0.21	0.21-0.30	0.25-0.38	0.29-0.43	
	9		45-60	0.08-0.12	0.13-0.21	0.21-0.30	0.25-0.38	0.29-0.43	
	10		High alloyed steel, and tool steel	50-65	0.10-0.16	0.13-0.21	0.18-0.26	0.20-0.31	0.24-0.35
	11			40-55	0.10-0.16	0.11-0.18	0.21-0.30	0.20-0.31	0.24-0.35
K	15	Grey cast iron	100-125	0.15-0.26	0.20-0.37	0.27-0.42	0.36-0.51	0.40-0.55	
	16		75-95	0.11-0.20	0.16-0.29	0.20-0.30	0.25-0.35	0.29-0.40	
	17	Nodular cast iron	95-120	0.13-0.22	0.17-0.31	0.21-0.32	0.28-0.40	0.32-0.44	
	18		75-95	0.11-0.20	0.14-0.26	0.19-0.29	0.25-0.35	0.29-0.40	
	19		100-125	0.13-0.22	0.17-0.31	0.21-0.32	0.28-0.40	0.32-0.44	
20	Malleable cast iron	75-95	0.11-0.18	0.14-0.26	0.19-0.29	0.25-0.35	0.29-0.40		

- ▶ The recommendations for speeds, feeds and other parameters presented in this chart are nominal recommendations and should be considered only as good starting points.
Speed and feed reductions (20% reduction in speed and 10% reduction in feed) are recommended.
- ▶ Recommend you to reduce the feed rate to 85%, 70% when you use 5xD, 7xD holders.
- ▶ For use of 7xD holder, we recommend to use a pilot drill with equal to or larger than 140° point angle (0.5xD - 1.5xD).
The use of the centering pre-hole improves hole location, roundness and surface finish.

Comparison with Split Point Drill, Spade Drill & Dream Drill



YA2C, YB2C, YC2C, YD2C, YE2C, YF2C, YG2C, YH2C, YI2C, YJ2C SERIES

i-DREAM DRILLS - INOX

 VC = m/min
 RPM = rev./min.
 FEED = mm/rev.

ISO	VDI 3323	Material Description	Vc (m/min)	Feed(mm/rev)				
				Ø12.00-14.99	Ø15.00-17.99	Ø18.00-21.90	Ø22.00-26.99	Ø27.00-31.99
P	1	Non-alloy steel	95-120	0.16-0.28	0.21-0.35	0.27-0.40	0.34-0.52	0.37-0.55
	2		80-105	0.14-0.24	0.21-0.35	0.27-0.40	0.34-0.52	0.37-0.55
	3		60-80	0.12-0.20	0.17-0.28	0.22-0.32	0.30-0.46	0.33-0.49
	4		55-70	0.10-0.16	0.15-0.25	0.21-0.30	0.25-0.38	0.29-0.43
	6	Low alloy steel	70-90	0.12-0.20	0.17-0.28	0.22-0.32	0.30-0.46	0.34-0.50
	7		60-80	0.12-0.20	0.15-0.25	0.22-0.32	0.30-0.46	0.34-0.50
	10	High alloyed steel, and tool steel	50-65	0.10-0.16	0.13-0.21	0.18-0.26	0.20-0.31	0.24-0.35
M	12	Stainless steel	30-45	0.08-0.14	0.09-0.15	0.10-0.16	0.12-0.20	0.14-0.22
	13		30-45	0.08-0.14	0.09-0.15	0.10-0.16	0.12-0.20	0.14-0.22
	14		45-60	0.10-0.16	0.12-0.18	0.14-0.20	0.15-0.26	0.18-0.28
N	21	Aluminum-wrought alloy	250-330	0.30-0.40	0.35-0.45	0.40-0.50	0.45-0.55	0.50-0.60
	22		200-250	0.30-0.40	0.35-0.45	0.40-0.50	0.45-0.55	0.50-0.60
	23	Aluminum-cast, alloyed	200-250	0.25-0.35	0.30-0.40	0.35-0.45	0.40-0.50	0.45-0.55
	24		150-220	0.25-0.35	0.30-0.40	0.35-0.45	0.40-0.50	0.45-0.55
	25		100-200	0.20-0.30	0.25-0.35	0.30-0.40	0.35-0.45	0.40-0.50
	26		115-145	0.16-0.28	0.23-0.36	0.29-0.36	0.37-0.45	0.41-0.48
	27	Copper and Copper Alloys (Bronze / Brass)	145-185	0.17-0.29	0.24-0.37	0.30-0.38	0.38-0.46	0.42-0.49
	28		95-120	0.06-0.09	0.09-0.13	0.11-0.13	0.15-0.18	0.19-0.22

- ▶ The recommendations for speeds, feeds and other parameters presented in this chart are nominal recommendations and should be considered only as good starting points.
Speed and feed reductions (20% reduction in speed and 10% reduction in feed) are recommended.
- ▶ Recommend you to reduce the feed rate to 85%, 70% when you use 5xD, 7xD holders.
- ▶ For use of 7xD holder, we recommend to use a pilot drill with equal to or larger than 140° point angle (0.5xD - 1.5xD).
The use of the centering pre-hole improves hole location, roundness and surface finish.

TEST I GENERAL

Cutting Condition

HOLDER	ZH14505020
INSERT	YB1A1450 / Ø14.5
Work Material	- ASTM : A36 - DIN : St37-2 - JIS : SS400
Cutting Speed	80 m/min
Feed	0.24 mm/rev.
Feedrate	421 mm/min.
RPM	1,756 rev./min.
Drilling	48.0 mm
Coolant	Internal
Machine type	Vertical Machining Center

RESULT

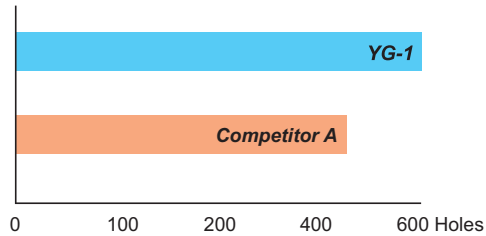

► YG-1 (Total Drilling 600 Holes)

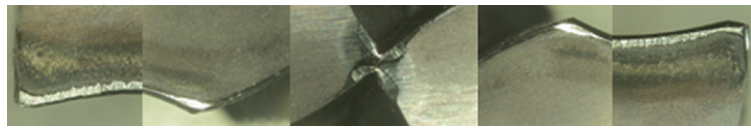

► Competitor A (Total Drilling 470 Holes)



TEST II INOX

Cutting Condition

HOLDER	ZH14005020
INSERT	YB2C1400 / Ø14.0
Work Material	- AISI : 304 - DIN : X5CrNi189 - JIS : SUS304
Cutting Speed	55 m/min
Feed	0.15 mm/rev.
Feedrate	188 mm/min.
RPM	1,250 rev./min.
Drilling	50.0 mm
Coolant	Internal
Machine type	Vertical Machining Center

RESULT

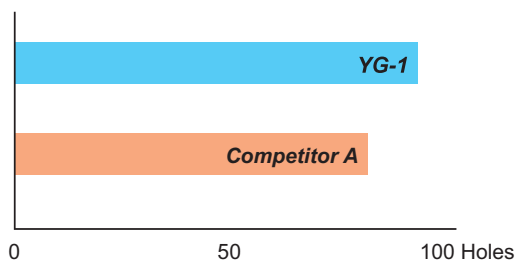

► YG-1 (Total Drilling 100 Holes)

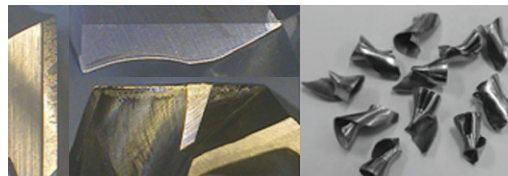

► Competitor A (Total Drilling 80 Holes)

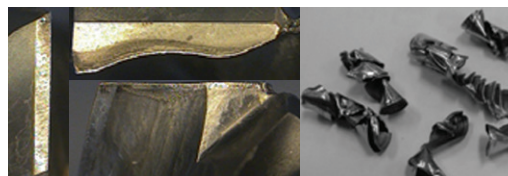

ASSEMBLY OF *i*-DREAM DRILLS
MONTAGE DES *i*-DREAM DRILLS





Make sure to clean the insert and insert seat.
Schneideinsatz und Haltersitz sorgfältig reinigen.



Slide the drill insert into the slot of the holder and press down the insert to touch the bottom of the slot.
Schneideinsatz in den Haltersitz einführen und den Schneideinsatz fest auf den Grund des Haltersitzes pressen.



After confirming the insert is pressed down to the bottom of the slot, tighten the screw using anti-seize compound.
Wenn der Schneideinsatz fest auf den Grund des Haltersitzes gepresst ist, die Schraube fest anziehen und dabei Spezialfett verwenden.

WRENCH TYPE	PRODUCT NO.	T-HANDLE No.	SERIES (SIZE)
 <p>WING TYPE</p>	TWWT08	—	A (Ø12.00-Ø13.99)
			B (Ø14.00-Ø15.99)
			C (Ø16.00-Ø17.99)
 <p>TORX BIT TYPE</p>	TWBT15	TWH600	D (Ø18.00-Ø19.99)
	TWBT20		E, F, G (Ø20.00-Ø25.99)
	TWBT25		H, I, J (Ø26.00-Ø31.99)

Use the wing type or T-type wrench.
Benutzen Sie den Winkeldreher oder T - Schlüsse

- ▶ Need to use appropriate wrenches and screws as indicated.
Unbedingt die angegebenen Schrauben und Dreher verwenden.
- ▶ It's important to tighten up the screw properly.
Es ist wichtig, die Schraube korrekt und fest anzuziehen.

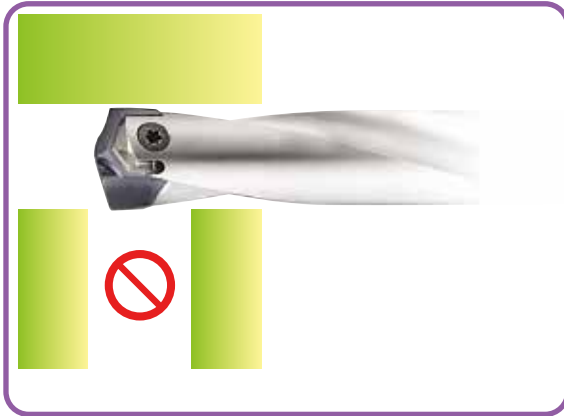
CAUTION-NOT RECOMMENDABLE APPLICATION
ACHTUNG - NICHT EMPFOHLENE ANWENDUNG

Intersecting cross hole is bigger than the drill insert's Margin Length.

Der Haltersitz ist größer als die Breite des Schneideinsatzes.

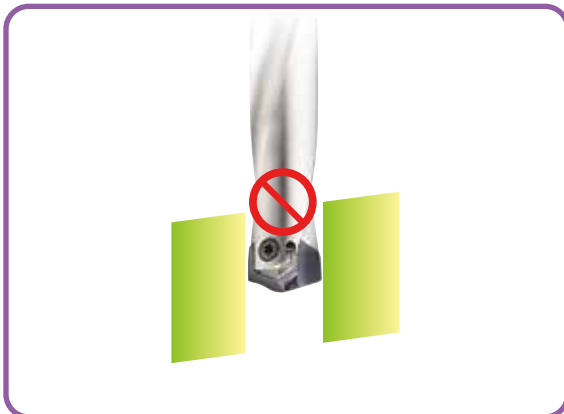

Material with slanting entrance and exit over 7 degrees. (If drilling 7 degrees or under slanting surface, reduce the feed about 30-50%)

Werkstücke mit schrägem Anschnitt oder Austritt von über 7°. (Zum Bohren von bis zu 7° Schräge den Vorschub um ca. 30-50% reduzieren).



For drilling stacked plates, minimize the space between the plates.

Beim Bohren von Blechpaketen den Abstand der Bleche minimieren.

The space between stacked plates can cause insert breakage or poor chip control.

Freiraum in Blechpaketen kann den Bruch des Schneideinsatzes oder schlechte Entspannung verursachen.

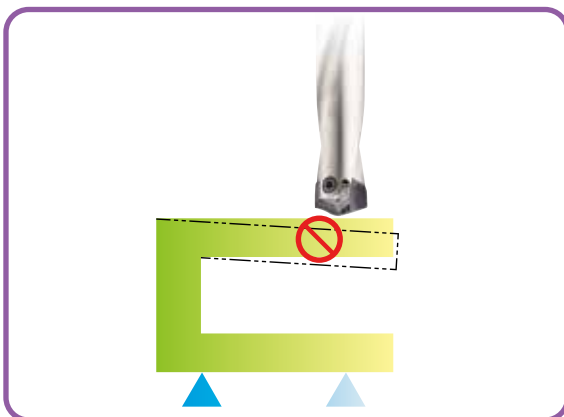

The material needs to be fixtured securely before drilling.

Das Werkstück muss fest und sicher aufgespannt sein

RECOMMENDED COOLANT PRESSURE AND FLOW RATE ON VERTICAL DRILLING
EMPFOHLENE KÜHLMITTELDRUCK UND - MENGE BEIM VERTIKALEN BOHREN

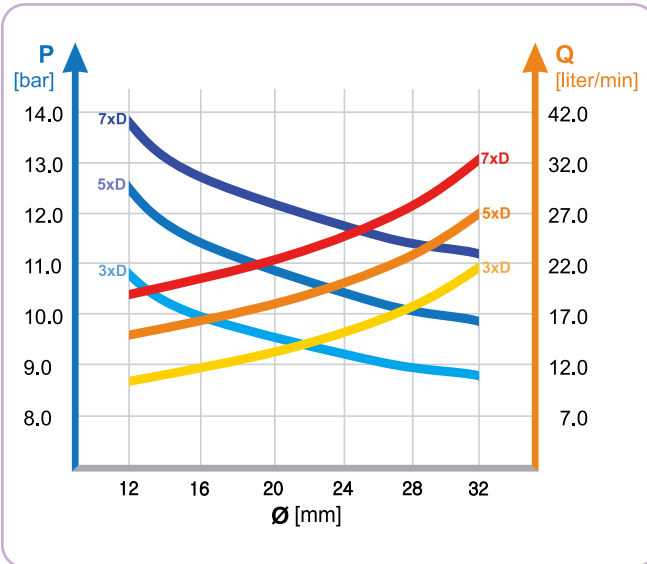

- Recommended emulsion mix is 6 - 8%.
Empfohlene Emulsionsmischung 6 - 8%.
- For Drilling into Stainless and High Strength steels, a mix of 10% is recommended.
Beim Bohren in rostfreie und hochfeste Stähle werden 10% empfohlen.
- For horizontal drilling, 30% reduction on the coolant pressure and flow rate is possible.
Beim horizontalen Bohren können Kühlmitteldruck und -menge um 30% gemindert werden.
- Dry drilling is possible for 1-2xD drilling. But not recommended.
Trocken Bohren ist möglich bei 1-2xD. Aber nicht empfohlen.

TROUBLE SHOOTING
PROBLEMLÖSUNGEN



- 1) Heavy flank wear / Fast flank wear**
- Reduce cutting speed
 - Increase feed



- 2) Chipping on cutting edge**
- Reduce feed
 - Check the rigidity of spindle and chuck
 - Rigid clamping of workpiece



- 3) Build-up on cutting edge**
- Increase cutting speed
 - Use a coated insert



- 4) Chipping or break down on outer corner**
- Reduce feed
 - Rigid clamping of workpiece



- 5) Wear of land margin**
- Rigid clamping of workpiece
 - Reduce cutting speed
 - Increase coolant flow

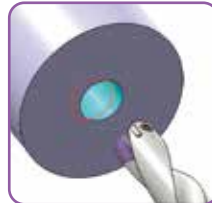

- 6) Unsatisfactory positioning of the hole**
- Rigid clamping of workpiece
 - Reduce feed during entrance or exit



- 7) Scratching on holder**
- Rigid clamping of workpiece
 - Reduce feed
 - Increase coolant flow

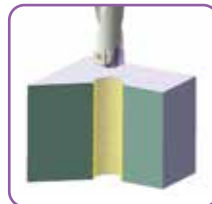

- 8) Unsatisfactory surface finish**
- Rigid clamping of workpiece
 - Increase coolant flow and pressure