

I-DREAM DRILL INSERTS & HOLDERS

i-DREAM DRILL EINSÄTZE UND HALTER

PLAQUETTES ET PORTE-PLAQUETTE I-DREAM DRILL - USAGE GÉNÉRAL / INOX
INSERTI & PORTAINSERTI I-DREAM DRILL

**- Features of i-Dream Drill Inserts-
 Merkmale des i-Dream Drill Einsätze**

- ▶ Secure and accurate seating resulting in accurate repeatability and concentricity.
 Der sichere und genaue Sitz der Platte garantiert genaue Wiederholbarkeit beim Einsatz und beim Rundlauf.
- i-Dream Drill General / i-Dream Drill allgemeinen**
- ▶ For most steels materials / In den meisten Stahlsorten
i-Dream Drill INOX / i-Dream Drill INOX
- ▶ For tough, ductile materials and stainless steels
 Für zähe, verformbare Werkstoffe und rostfreie Stähle.
- ▶ Light, sharp cutting edge / Scharfe Schneidkante
- ▶ Soft cutting action / Weicher Schnitt
- ▶ Minimize cutting forces / Minimaler Schneidendruck
- ▶ Reduce built-up edge / Reduzierte Gratbildung

**- Features of i-Dream Drill Holders-
 - Merkmale des i-Dream Drill Halter-**

- ▶ Special Alloy Steels maintain its hardness and toughness under high temperatures.
 Speziell legierter Stahl, der seine Härte und Zähigkeit auch bei hohen Temperaturen behält.
- ▶ Innovative surface treatment improves wear resistance and reduces corrosion.
 Innovative Oberflächenbehandlung, die die Verschleissfestigkeit erhöht und die Korrosion vermindert.
- ▶ High Performance flute design allows maximum chip evacuation and minimum interference.
 Optimierte Nutenform für maximale Spanabfuhr.



Recommended ToolHolder	Flat Shank	Page	Plain Shank	Page
	INDEXABLE DRILL HOLDER	D245-246	-	-
	ER COLLET CHUCK			D73-115

Unit : mm

Series Range (mm)	Insert EDP No.		Insert O.D.			Holder EDP No.	Shank Dia. SD	Shank Length L2	Flange Dia. FD	Drilling Depth		Overall Length L3 Ref.	Screw No.	
	General (TiAlN)	INOX (TiCN)	h7							L1	L3 Ref.			
			dec.	frac.	mm									
Ø28.00 to Ø29.99	Y11A2800	Y12C2800	1.1024	-	28.00	ZH28003032	32	60	37	3D	84	178.2	TX2829T25	
	Y11A2818	Y12C2818	1.1094	1-7/64	28.18	ZH28005032				5D	140			234.2
	Y11A2850	Y12C2850	1.1220	-	28.50	ZH28007032				7D	196			290.2
	Y11A2858	Y12C2858	1.1250	1-1/8	28.58	ZH28503032	3D	85.5	179.2					
	Y11A2900	Y12C2900	1.1417	-	29.00	ZH28505032	5D	142.5	236.2					
	Y11A2937	Y12C2937	1.1562	1-5/32	29.37	ZH28507032	7D	199.5	293.2					
	Y11A2950	Y12C2950	1.1614	-	29.50	ZH29003032	32	60	37	3D	87	182.2	TX2930T25	
	Y11A2977	Y12C2977	1.1719	1-11/64	29.77	ZH29005032				5D	145			240.2
						ZH29007032	7D	203	298.2					
						ZH29503032	3D	88.5	183.2					
					ZH29505032	5D	147.5	242.2						
					ZH29507032	7D	206.5	301.2						

▶ Other diameters of insert and shank types of holder are available upon request.

◎ : Excellent ○ : Good

ISO Material Description	P									M				K						
	Non-alloy steel					Low alloy steel				High alloyed steel, and tool steel		Stainless steel		Grey cast iron		Nodular cast iron		Malleable cast iron		
VDI 3323	1	2	3	4	5	6	7	8	9	10	11	12	13	14	15	16	17	18	19	20
HRc		13	25	28	32	10	29	32	38	10	15	15	23	10	10	26	3	25		
HB	125	190	250	270	300	180	275	300	350	200	325	200	240	180	180	260	160	250	130	230
Y11A	◎	◎	◎	◎	◎	◎	◎	◎	◎	◎	◎				◎	◎	◎	◎	◎	◎
Y12C	○	○	○	○	○	○	○	○	○	○	○	◎	◎	◎						

ISO Material Description	N					S										H					
	Aluminum-wrought alloy		Aluminum-cast, alloyed			Copper and Copper Alloys (Bronze / Brass)			Non Metallic Materials		Heat Resistant Super Alloys					Titanium Alloys		Hardened steel	Chilled Cast Iron	Hardened Cast Iron	
VDI 3323	21	22	23	24	25	26	27	28	29	30	31	32	33	34	35	36	37	38	39	40	41
HRc											15	30	25	38	34			55	60	42	55
HB	60	100	75	90	130	110	90	100			200	280	250	350	320	400Rm	1050Rm	550	630	400	550
Y11A																					
Y12C	○	○	○	○	○	○	○	○													

Stable Insert locking System

- V type locking system allowed for stabilized drilling
- Design that fastening screw doesn't touch insert to protect the insert locking system from the vibration during the drilling cycle

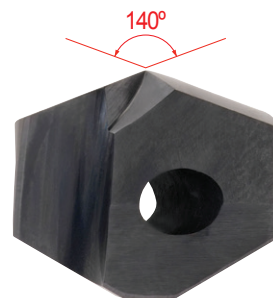
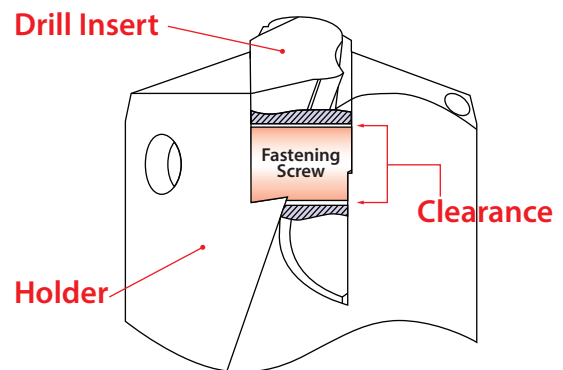
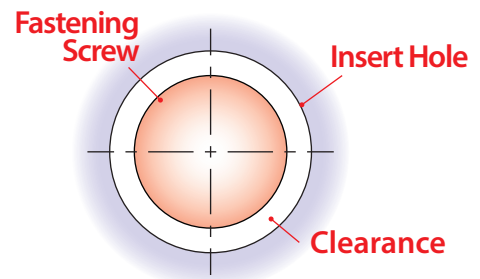
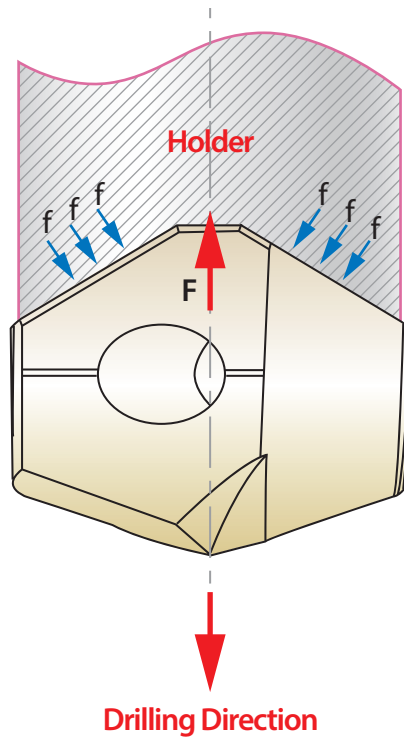

Self-Centering 140° Point & Helical Thinning

- Excellent Centering
- Minimized cutting resistance
- Design for maximum toughness, hardness and chip evacuation
- High penetration rate
- Reduced heat from cutting edge processing to allow long tool life
- Lower required torque and horsepower

SELECTION GUIDE



SERIES	YH1A	YH2C
TYPE	H	
SIZE MIN	26.00	
SIZE MAX	27.78	
PAGE	A51	
SURFACE TREATMENT	TiAlN	TiCN

CARBIDE INSERTS & HOLDERS

i-DREAM DRILLS

For General Steels and Stainless Steels



Please visit globalyg1.com/mat for material search

◎ : Excellent ○ : Good

Recommended cutting conditions : p.A54, 55

ISO	VDI 3323	Material Description	Composition / Structure / Heat Treatment	HB	HRc		
P	1	Non-alloy steel	About 0.15% C Annealed	125		◎	○
	2		About 0.45% C Annealed	190	13	◎	○
	3		About 0.45% C Quenched & Tempered	250	25	◎	○
	4		About 0.75% C Annealed	270	28	◎	○
	5		About 0.75% C Quenched & Tempered	300	32	◎	
	6	Low alloy steel	Annealed	180	10	◎	○
	7		Quenched & Tempered	275	29	◎	○
	8		Quenched & Tempered	300	32	◎	
	9		Quenched & Tempered	350	38	◎	
	10		High alloyed steel, and tool steel	Annealed	200	15	◎
	11	Quenched & Tempered		325	35	◎	
M	12	Stainless steel	Ferritic / Martensitic Annealed	200	15		◎
	13		Martensitic Quenched & Tempered	240	23		◎
	14		Austenitic	180	10		◎
K	15	Grey cast iron	Pearlitic / ferritic	180	10	◎	
	16		Pearlitic (Martensitic)	260	26	◎	
	17	Nodular cast iron	Ferritic	160	3	◎	
	18		Pearlitic	250	25	◎	
	19		Ferritic	130		◎	
20	Malleable cast iron	Pearlitic	230	21	◎		
N	21	Aluminum-wrought alloy	Not Curable	60			○
	22		Curable Hardened	100			○
	23	Aluminum-cast, alloyed	≤ 12% Si, Not Curable	75			○
	24		≤ 12% Si, Curable Hardened	90			○
	25		> 12% Si, Not Curable	130			○
	26	Copper and Copper Alloys (Bronze / Brass)	Cutting Alloys, PB>1%	110			○
	27		CuZn, CuSnZn (Brass)	90			○
	28		CuSn, lead-free copper and electrolytic copper	100			○
	29		Non Metallic Materials	Duroplastic, Fiber Reinforced Plastic			
30	Rubber, Wood, etc.						
S	31	Heat Resistant Super Alloys	Fe Based Annealed	200	15		
	32		Cured	280	30		
	33		Annealed	250	25		
	34	Titanium Alloys	Ni or Co Based Cured	350	38		
	35		Cast	320	34		
	36		Pure Titanium	400 Rm			
37	Alpha + Beta Alloys	Hardened	1050 Rm				
H	38	Hardened steel	Hardened	550	55		
	39		Hardened	630	60		
	40	Chilled Cast Iron	Cast	400	42		
	41	Hardened Cast Iron	Hardened	550	55		

Y11A	Y12C	YJ1A	YJ2C	ZH*3	ZH*5	ZH*7
I		J				
28.00		30.00				
29.77		31.75				
A52		A53				
TiAlN	TiCN	TiAlN	TiCN	3XD	5XD	7XD



⊙	○	⊙	○				1
⊙	○	⊙	○				2
⊙	○	⊙	○				3
⊙	○	⊙	○				4
⊙	○	⊙	○				5
⊙	○	⊙	○				6 P
⊙	○	⊙	○				7
⊙	○	⊙	○				8
⊙	○	⊙	○				9
⊙	○	⊙	○				10
⊙	○	⊙	○				11
	⊙		⊙				12
	⊙		⊙				13 M
	⊙		⊙				14
⊙		⊙					15
⊙		⊙					16
⊙		⊙					17 K
⊙		⊙					18
⊙		⊙					19
⊙		⊙					20
	○		○				21
	○		○				22
	○		○				23
	○		○				24
	○		○				25 N
	○		○				26
	○		○				27
	○		○				28
							29
							30
							31
							32
							33
							34 S
							35
							36
							37
							38
							39 H
							40
							41

HSS

i-ONE DRILLS

i-DREAM DRILLS

DREAM DRILLS -PRO

DREAM DRILLS -GENERAL

DREAM DRILLS -HIGH FEED

DREAM DRILLS -FLAT BOTTOM

DREAM DRILLS -INOX

DREAM DRILLS -ALU

DREAM DRILLS -MQL

DREAM DRILLS for HIGH HARDENED STEELS

GENERAL CARBIDE DRILLS

MULTI-1 DRILLS

HPD DRILLS

GOLD-P DRILLS

SUPER-GP DRILLS

STRAIGHT SHANK DRILLS

TAPER SHANK DRILLS

NC-SPOTTING DRILLS

CENTER DRILLS

SPADE DRILLS

REAMERS

COUNTER SINKS

COUNTER BORES

TECHNICAL DATA

YA1A, YB1A, YC1A, YD1A, YE1A, YF1A, YG1A, YH1A, YI1A, YJ1A SERIES

i-DREAM DRILLS - GENERAL

VC = M/MIN
RPM = rev./min.
FEED = mm/rev.

ISO	VDI 3323	Material Description	Vc (m/min)	Feed(mm/rev)					
				Ø12.00-14.99	Ø15.00-17.99	Ø18.00-21.99	Ø22.00-26.99	Ø27.00-31.99	
P	1	Non-alloy steel	95-120	0.16-0.28	0.21-0.35	0.27-0.40	0.34-0.52	0.37-0.55	
	2		80-105	0.14-0.24	0.21-0.35	0.27-0.40	0.34-0.52	0.37-0.55	
	3		60-80	0.12-0.20	0.17-0.28	0.22-0.32	0.30-0.46	0.33-0.49	
	4		55-70	0.10-0.16	0.15-0.25	0.21-0.30	0.25-0.38	0.29-0.43	
	5	Low alloy steel	55-70	0.10-0.16	0.15-0.25	0.21-0.30	0.25-0.38	0.29-0.43	
	6		70-90	0.12-0.20	0.17-0.28	0.22-0.32	0.30-0.46	0.34-0.50	
	7		60-80	0.12-0.20	0.15-0.25	0.22-0.32	0.30-0.46	0.34-0.50	
	8		55-70	0.10-0.16	0.13-0.21	0.21-0.30	0.25-0.38	0.29-0.43	
	9		45-60	0.08-0.12	0.13-0.21	0.21-0.30	0.25-0.38	0.29-0.43	
	10		High alloyed steel, and tool steel	50-65	0.10-0.16	0.13-0.21	0.18-0.26	0.20-0.31	0.24-0.35
	11			40-55	0.10-0.16	0.11-0.18	0.21-0.30	0.20-0.31	0.24-0.35
K	15	Grey cast iron	100-125	0.15-0.26	0.20-0.37	0.27-0.42	0.36-0.51	0.40-0.55	
	16		75-95	0.11-0.20	0.16-0.29	0.20-0.30	0.25-0.35	0.29-0.40	
	17	Nodular cast iron	95-120	0.13-0.22	0.17-0.31	0.21-0.32	0.28-0.40	0.32-0.44	
	18		75-95	0.11-0.20	0.14-0.26	0.19-0.29	0.25-0.35	0.29-0.40	
	19		100-125	0.13-0.22	0.17-0.31	0.21-0.32	0.28-0.40	0.32-0.44	
20	Malleable cast iron	75-95	0.11-0.18	0.14-0.26	0.19-0.29	0.25-0.35	0.29-0.40		

- ▶ The recommendations for speeds, feeds and other parameters presented in this chart are nominal recommendations and should be considered only as good starting points.
Speed and feed reductions (20% reduction in speed and 10% reduction in feed) are recommended.
- ▶ Recommend you to reduce the feed rate to 85%, 70% when you use 5xD, 7xD holders.
- ▶ For use of 7xD holder, we recommend to use a pilot drill with equal to or larger than 140° point angle (0.5xD - 1.5xD).
The use of the centering pre-hole improves hole location, roundness and surface finish.

Comparison with Split Point Drill, Spade Drill & Dream Drill



**YA2C, YB2C, YC2C, YD2C, YE2C,
YF2C, YG2C, YH2C, YI2C, YJ2C** SERIES

i-DREAM DRILLS - INOX

 VC = m/min
 RPM = rev./min.
 FEED = mm/rev.

ISO	VDI 3323	Material Description	Vc (m/min)	Feed(mm/rev)					
				Ø12.00-14.99	Ø15.00-17.99	Ø18.00-21.90	Ø22.00-26.99	Ø27.00-31.99	
P	1	Non-alloy steel	95-120	0.16-0.28	0.21-0.35	0.27-0.40	0.34-0.52	0.37-0.55	
	2		80-105	0.14-0.24	0.21-0.35	0.27-0.40	0.34-0.52	0.37-0.55	
	3		60-80	0.12-0.20	0.17-0.28	0.22-0.32	0.30-0.46	0.33-0.49	
	4		55-70	0.10-0.16	0.15-0.25	0.21-0.30	0.25-0.38	0.29-0.43	
	6	Low alloy steel	70-90	0.12-0.20	0.17-0.28	0.22-0.32	0.30-0.46	0.34-0.50	
	7		60-80	0.12-0.20	0.15-0.25	0.22-0.32	0.30-0.46	0.34-0.50	
	10		High alloyed steel, and tool steel	50-65	0.10-0.16	0.13-0.21	0.18-0.26	0.20-0.31	0.24-0.35
M	12	Stainless steel	30-45	0.08-0.14	0.09-0.15	0.10-0.16	0.12-0.20	0.14-0.22	
	13		30-45	0.08-0.14	0.09-0.15	0.10-0.16	0.12-0.20	0.14-0.22	
	14		45-60	0.10-0.16	0.12-0.18	0.14-0.20	0.15-0.26	0.18-0.28	
N	21	Aluminum-wrought alloy	250-330	0.30-0.40	0.35-0.45	0.40-0.50	0.45-0.55	0.50-0.60	
	22		200-250	0.30-0.40	0.35-0.45	0.40-0.50	0.45-0.55	0.50-0.60	
	23	Aluminum-cast, alloyed	200-250	0.25-0.35	0.30-0.40	0.35-0.45	0.40-0.50	0.45-0.55	
	24		150-220	0.25-0.35	0.30-0.40	0.35-0.45	0.40-0.50	0.45-0.55	
	25		100-200	0.20-0.30	0.25-0.35	0.30-0.40	0.35-0.45	0.40-0.50	
	26		Copper and Copper Alloys (Bronze / Brass)	115-145	0.16-0.28	0.23-0.36	0.29-0.36	0.37-0.45	0.41-0.48
	27			145-185	0.17-0.29	0.24-0.37	0.30-0.38	0.38-0.46	0.42-0.49
	28			95-120	0.06-0.09	0.09-0.13	0.11-0.13	0.15-0.18	0.19-0.22

- ▶ The recommendations for speeds, feeds and other parameters presented in this chart are nominal recommendations and should be considered only as good starting points.
Speed and feed reductions (20% reduction in speed and 10% reduction in feed) are recommended.
- ▶ Recommend you to reduce the feed rate to 85%, 70% when you use 5xD, 7xD holders.
- ▶ For use of 7xD holder, we recommend to use a pilot drill with equal to or larger than 140° point angle (0.5xD - 1.5xD).
The use of the centering pre-hole improves hole location, roundness and surface finish.

TEST I GENERAL

Cutting Condition

HOLDER	ZH14505020
INSERT	YB1A1450 / Ø14.5
Work Material	- ASTM : A36 - DIN : St37-2 - JIS : SS400
Cutting Speed	80 m/min
Feed	0.24 mm/rev.
Feedrate	421 mm/min.
RPM	1,756 rev./min.
Drilling	48.0 mm
Coolant	Internal
Machine type	Vertical Machining Center

RESULT

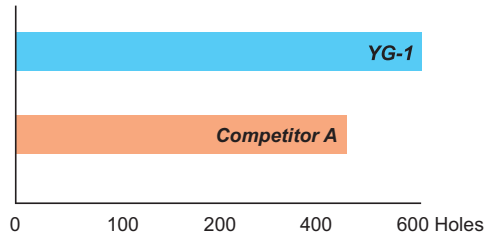

► YG-1 (Total Drilling 600 Holes)



► Competitor A (Total Drilling 470 Holes)



TEST II INOX

Cutting Condition

HOLDER	ZH14005020
INSERT	YB2C1400 / Ø14.0
Work Material	- AISI : 304 - DIN : X5CrNi189 - JIS : SUS304
Cutting Speed	55 m/min
Feed	0.15 mm/rev.
Feedrate	188 mm/min.
RPM	1,250 rev./min.
Drilling	50.0 mm
Coolant	Internal
Machine type	Vertical Machining Center

RESULT

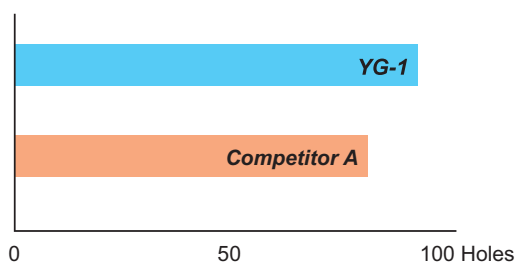

► YG-1 (Total Drilling 100 Holes)

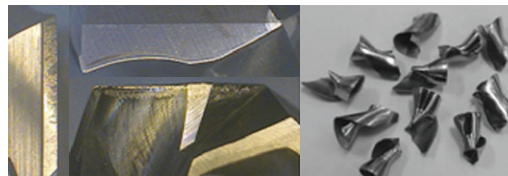

► Competitor A (Total Drilling 80 Holes)

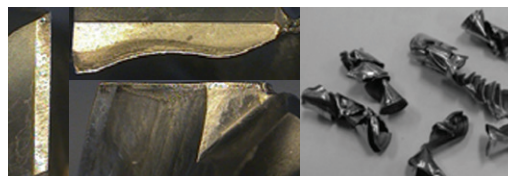

ASSEMBLY OF *i*-DREAM DRILLS
MONTAGE DES *i*-DREAM DRILLS



Make sure to clean the insert and insert seat.

Schneideinsatz und Haltersitz sorgfältig reinigen.



Slide the drill insert into the slot of the holder and press down the insert to touch the bottom of the slot.

Schneideinsatz in den Haltersitz einführen und den Schneideinsatz fest auf den Grund des Haltersitzes pressen.



After confirming the insert is pressed down to the bottom of the slot, tighten the screw using anti-seize compound.

Wenn der Schneideinsatz fest auf den Grund des Haltersitzes gepresst ist, die Schraube fest anziehen und dabei Spezialfett verwenden.

WRENCH TYPE	PRODUCT NO.	T-HANDLE No.	SERIES (SIZE)
 <p>WING TYPE</p>	TWWT08	—	A (Ø12.00-Ø13.99)
			B (Ø14.00-Ø15.99)
			C (Ø16.00-Ø17.99)
 <p>TORX BIT TYPE</p>	TWBT15	TWH600	D (Ø18.00-Ø19.99)
	TWBT20		E, F, G (Ø20.00-Ø25.99)
	TWBT25		H, I, J (Ø26.00-Ø31.99)

Use the wing type or T-type wrench.
Benutzen Sie den Winkeldreher oder T - Schlüsse

- ▶ Need to use appropriate wrenches and screws as indicated.
Unbedingt die angegebenen Schrauben und Dreher verwenden.
- ▶ It's important to tighten up the screw properly.
Es ist wichtig, die Schraube korrekt und fest anzuziehen.

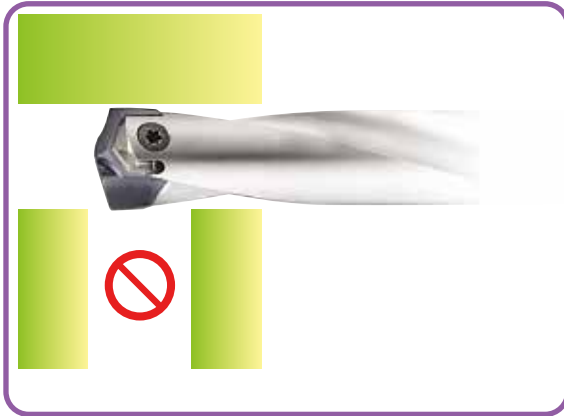
CAUTION-NOT RECOMMENDABLE APPLICATION
ACHTUNG - NICHT EMPFOHLENE ANWENDUNG

Intersecting cross hole is bigger than the drill insert's Margin Length.

Der Haltersitz ist größer als die Breite des Schneideinsatzes.

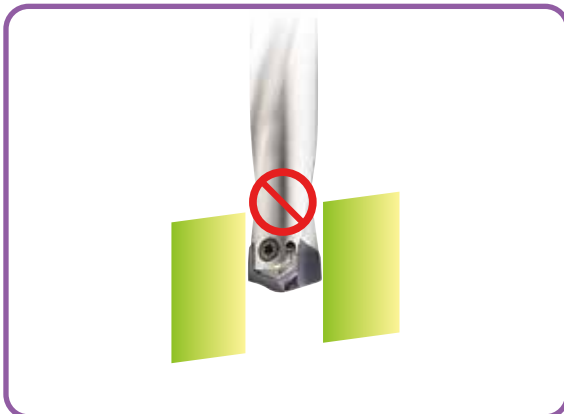

Material with slanting entrance and exit over 7 degrees. (If drilling 7 degrees or under slanting surface, reduce the feed about 30-50%)

Werkstücke mit schrägem Anschnitt oder Austritt von über 7°. (Zum Bohren von bis zu 7° Schräge den Vorschub um ca. 30-50% reduzieren).



For drilling stacked plates, minimize the space between the plates.

Beim Bohren von Blechpaketen den Abstand der Bleche minimieren.

The space between stacked plates can cause insert breakage or poor chip control.

Freiraum in Blechpaketen kann den Bruch des Schneideinsatzes oder schlechte Entspannung verursachen.

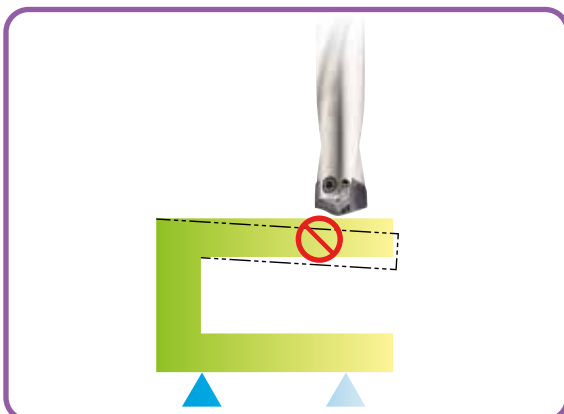

The material needs to be fixtured securely before drilling.

Das Werkstück muss fest und sicher aufgespannt sein

RECOMMENDED COOLANT PRESSURE AND FLOW RATE ON VERTICAL DRILLING
EMPFOHLENE KÜHLMITTELDRUCK UND - MENGE BEIM VERTIKALEN BOHREN

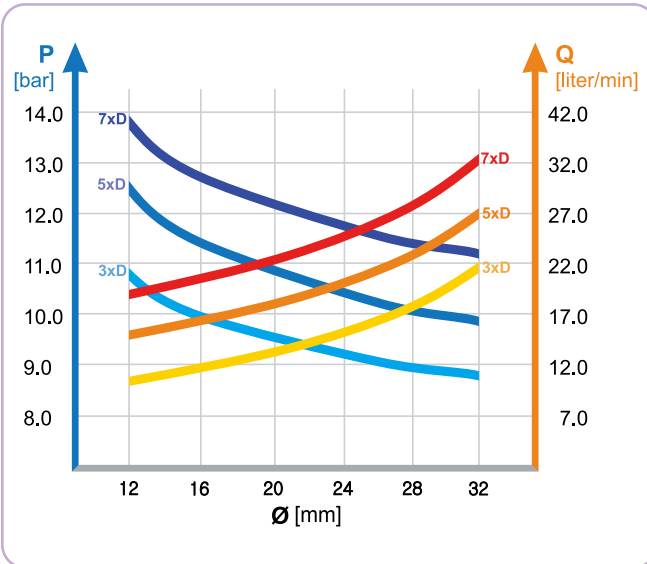

- Recommended emulsion mix is 6 - 8%.
Empfohlene Emulsionsmischung 6 - 8%.
- For Drilling into Stainless and High Strength steels, a mix of 10% is recommended.
Beim Bohren in rostfreie und hochfeste Stähle werden 10% empfohlen.
- For horizontal drilling, 30% reduction on the coolant pressure and flow rate is possible.
Beim horizontalen Bohren können Kühlmitteldruck und -menge um 30% gemindert werden.
- Dry drilling is possible for 1-2xD drilling. But not recommended.
Trocken Bohren ist möglich bei 1-2xD. Aber nicht empfohlen.

TROUBLE SHOOTING
PROBLEMLÖSUNGEN



- 1) Heavy flank wear / Fast flank wear**
- Reduce cutting speed
 - Increase feed



- 2) Chipping on cutting edge**
- Reduce feed
 - Check the rigidity of spindle and chuck
 - Rigid clamping of workpiece



- 3) Build-up on cutting edge**
- Increase cutting speed
 - Use a coated insert



- 4) Chipping or break down on outer corner**
- Reduce feed
 - Rigid clamping of workpiece



- 5) Wear of land margin**
- Rigid clamping of workpiece
 - Reduce cutting speed
 - Increase coolant flow

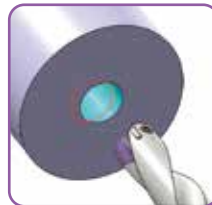

- 6) Unsatisfactory positioning of the hole**
- Rigid clamping of workpiece
 - Reduce feed during entrance or exit



- 7) Scratching on holder**
- Rigid clamping of workpiece
 - Reduce feed
 - Increase coolant flow

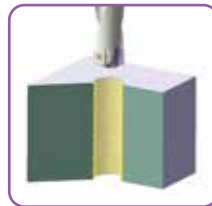

- 8) Unsatisfactory surface finish**
- Rigid clamping of workpiece
 - Increase coolant flow and pressure