

I-DREAM DRILL INSERTS & HOLDERS

i-DREAM DRILL EINSÄTZE UND HALTER

PLAQUETTES ET PORTE-PLAQUETTE I-DREAM DRILL - USAGE GÉNÉRAL / INOX
INSERTI & PORTAINSERTI I-DREAM DRILL

**- Features of i-Dream Drill Inserts-
 Merkmale des i-Dream Drill Einsätze**

- ▶ Secure and accurate seating resulting in accurate repeatability and concentricity.
 Der sichere und genaue Sitz der Platte garantiert genaue Wiederholbarkeit beim Einsatz und beim Rundlauf.
- i-Dream Drill General / i-Dream Drill allgemeinen**
- ▶ For most steels materials / In den meisten Stahlsorten
i-Dream Drill INOX / i-Dream Drill INOX
- ▶ For tough, ductile materials and stainless steels
 Für zähe, verformbare Werkstoffe und rostfreie Stähle.
- ▶ Light, sharp cutting edge / Scharfe Schneidkante
- ▶ Soft cutting action / Weicher Schnitt
- ▶ Minimize cutting forces / Minimaler Schneidendruck
- ▶ Reduce built-up edge / Reduzierte Gratbildung

**- Features of i-Dream Drill Holders-
 - Merkmale des i-Dream Drill Halter-**

- ▶ Special Alloy Steels maintain its hardness and toughness under high temperatures.
 Speziell legierter Stahl, der seine Härte und Zähigkeit auch bei hohen Temperaturen behält.
- ▶ Innovative surface treatment improves wear resistance and reduces corrosion.
 Innovative Oberflächenbehandlung, die die Verschleissfestigkeit erhöht und die Korrosion vermindert.
- ▶ High Performance flute design allows maximum chip evacuation and minimum interference.
 Optimierte Nutzenform für maximale Spanabfuhr.



| | | | | |
|------------------------|------------------------|----------|-------------|---------|
| Recommended ToolHolder | Flat Shank | Page | Plain Shank | Page |
| | INDEXABLE DRILL HOLDER | D245-246 | - | - |
| | ER COLLET CHUCK | | | D73-115 |

Unit : mm

| Series Range (mm) | Insert EDP No. | | Insert O.D. | | | Holder EDP No. | Shank Dia. SD | Shank Length L2 | Flange Dia. FD | Drilling Depth | | Overall Length L3 Ref. | Screw No. | |
|-----------------------|-----------------|-------------|-------------|-------|------------|----------------|---------------|-----------------|----------------|----------------|---------|------------------------|-----------|-----------|
| | General (TiAlN) | INOX (TiCN) | dec. | frac. | mm | | | | | L1 | L3 Ref. | | | |
| G Ø24.00 to Ø25.99 | YG1A2400 | YG2C2400 | .9449 | - | 24.00 | ZH24003032 | 32 | 60 | 37 | 3D | 72 | 164.8 | TX2425T20 | |
| | YG1A2421 | YG2C2421 | .9531 | 61/64 | 24.21 | ZH24005032 | | | | 5D | 120 | 212.8 | | |
| | YG1A2450 | YG2C2450 | .9646 | - | 24.50 | ZH24007032 | | | | 7D | 168 | 260.8 | | |
| | YG1A2461 | YG2C2461 | .9688 | 31/32 | 24.61 | ZH24503032 | 32 | 60 | 37 | 3D | 73.5 | 165.8 | | |
| | YG1A2470 | YG2C2470 | .9724 | - | 24.70 | ZH24505032 | | | | 5D | 122.5 | 214.8 | | |
| | YG1A2500 | YG2C2500 | .9843 | 63/64 | 25.00 | ZH24507032 | | | | 7D | 171.5 | 263.8 | | |
| | YG1A2540 | YG2C2540 | 1.0000 | 1 | 25.40 | ZH25003032 | 32 | 60 | 37 | 3D | 75 | 167.8 | | TX2526T20 |
| | YG1A2550 | YG2C2550 | 1.0039 | - | 25.50 | ZH25005032 | | | | 5D | 125 | 217.8 | | |
| | YG1A2567 | YG2C2567 | 1.0106 | - | 25.67 | ZH25007032 | | | | 7D | 175 | 267.8 | | |
| | YG1A2570 | YG2C2570 | 1.0118 | - | 25.70 | ZH25503032 | 32 | 60 | 37 | 3D | 76.5 | 170.8 | | |
| YG1A2580 | YG2C2580 | 1.0156 | 1-1/64 | 25.80 | ZH25505032 | 5D | | | | 127.5 | 221.8 | | | |
| | | | | | ZH25507032 | 7D | | | | 178.5 | 272.8 | | | |

▶ Other diameters of insert and shank types of holder are available upon request.

◎ : Excellent ○ : Good

| ISO Material Description | P | | | | | | | | | M | | | | K | | | | | | |
|--------------------------|-----------------|-----|-----|-----|-----|-----------------|-----|-----|-----|------------------------------------|-----|-----------------|-----|----------------|-----|-------------------|-----|---------------------|-----|-----|
| | Non-alloy steel | | | | | Low alloy steel | | | | High alloyed steel, and tool steel | | Stainless steel | | Grey cast iron | | Nodular cast iron | | Malleable cast iron | | |
| VDI 3323 | 1 | 2 | 3 | 4 | 5 | 6 | 7 | 8 | 9 | 10 | 11 | 12 | 13 | 14 | 15 | 16 | 17 | 18 | 19 | 20 |
| HRc | | 13 | 25 | 28 | 32 | 10 | 29 | 32 | 38 | 15 | 35 | 15 | 23 | 10 | 10 | 26 | 3 | 25 | | 21 |
| HB | 125 | 190 | 250 | 270 | 300 | 180 | 275 | 300 | 350 | 200 | 325 | 200 | 240 | 180 | 180 | 260 | 160 | 250 | 130 | 230 |
| YG1A | ◎ | ◎ | ◎ | ◎ | ◎ | ◎ | ◎ | ◎ | ◎ | ◎ | ◎ | | | | ◎ | ◎ | ◎ | ◎ | ◎ | ◎ |
| YG2C | ○ | ○ | ○ | ○ | ○ | ○ | ○ | ○ | ○ | ○ | ○ | ◎ | ◎ | ◎ | | | | | | |

| ISO Material Description | N | | | | | S | | | | | | | | | | H | | | | | |
|--------------------------|------------------------|-----|------------------------|----|-----|---|----|-----|------------------------|----|-----------------------------|-----|-----|-----|-----|-----------------|--------|----------------|-------------------|--------------------|-----|
| | Aluminum-wrought alloy | | Aluminum-cast, alloyed | | | Copper and Copper Alloys (Bronze / Brass) | | | Non Metallic Materials | | Heat Resistant Super Alloys | | | | | Titanium Alloys | | Hardened steel | Chilled Cast Iron | Hardened Cast Iron | |
| VDI 3323 | 21 | 22 | 23 | 24 | 25 | 26 | 27 | 28 | 29 | 30 | 31 | 32 | 33 | 34 | 35 | 36 | 37 | 38 | 39 | 40 | 41 |
| HRc | | | | | | | | | | | 15 | 30 | 25 | 38 | 34 | | | 55 | 60 | 42 | 55 |
| HB | 60 | 100 | 75 | 90 | 130 | 110 | 90 | 100 | | | 200 | 280 | 250 | 350 | 320 | 400Rm | 1050Rm | 550 | 630 | 400 | 550 |
| YG1A | | | | | | | | | | | | | | | | | | | | | |
| YG2C | ○ | ○ | ○ | ○ | ○ | ○ | ○ | ○ | ○ | ○ | | | | | | | | | | | |

Stable Insert locking System

- V type locking system allowed for stabilized drilling
- Design that fastening screw doesn't touch insert to protect the insert locking system from the vibration during the drilling cycle

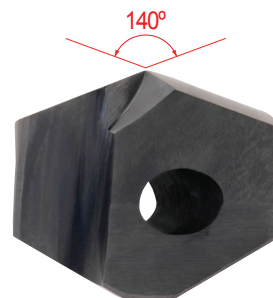
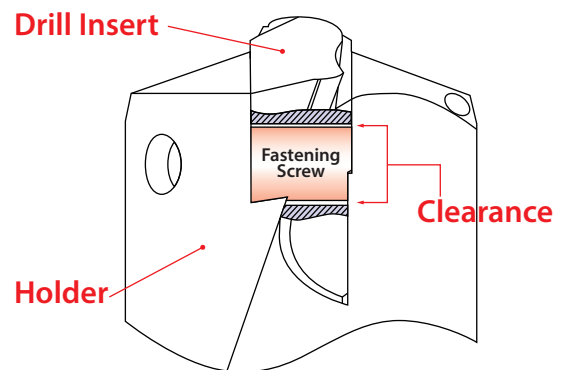
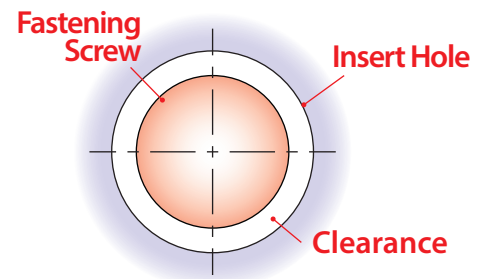
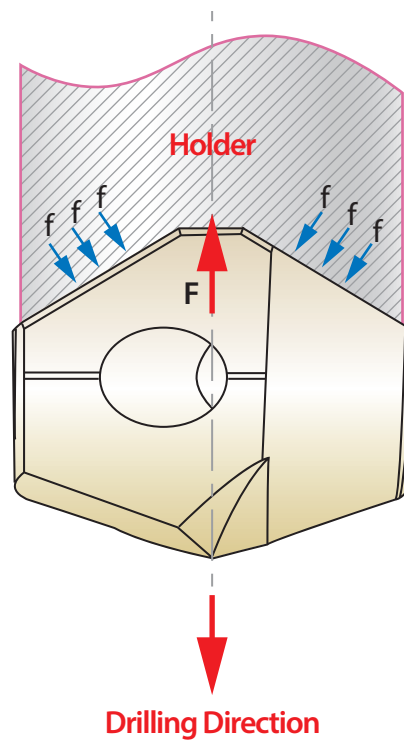

Self-Centering 140° Point & Helical Thinning

- Excellent Centering
- Minimized cutting resistance
- Design for maximum toughness, hardness and chip evacuation
- High penetration rate
- Reduced heat from cutting edge processing to allow long tool life
- Lower required torque and horsepower



SELECTION GUIDE



| SERIES | YA1A | YA2C | YB1A | YB2C |
|-------------------|-------|------|-------|------|
| TYPE | A | | B | |
| SIZE MIN | 12.00 | | 14.00 | |
| SIZE MAX | 13.89 | | 15.87 | |
| PAGE | A44 | | A45 | |
| SURFACE TREATMENT | TiAIN | TiCN | TiAIN | TiCN |

CARBIDE INSERTS & HOLDERS

i-DREAM DRILLS

For General Steels and Stainless Steels



Please visit globalyg1.com/mat for material search

◎ : Excellent ○ : Good

Recommended cutting conditions : p.A54, 55

| ISO | VDI 3323 | Material Description | Composition / Structure / Heat Treatment | | HB | HRc | TiAIN | TiCN | TiAIN | TiCN |
|-----|---------------------|---|--|---------------------|----------|-----|-------|------|-------|------|
| P | 1 | Non-alloy steel | About 0.15% C | Annealed | 125 | | ◎ | ○ | ◎ | ○ |
| | 2 | | About 0.45% C | Annealed | 190 | 13 | ◎ | ○ | ◎ | ○ |
| | 3 | | About 0.45% C | Quenched & Tempered | 250 | 25 | ◎ | ○ | ◎ | ○ |
| | 4 | | About 0.75% C | Annealed | 270 | 28 | ◎ | ○ | ◎ | ○ |
| | 5 | | About 0.75% C | Quenched & Tempered | 300 | 32 | ◎ | | ◎ | |
| | 6 | Low alloy steel | | Annealed | 180 | 10 | ◎ | ○ | ◎ | ○ |
| | 7 | | | Quenched & Tempered | 275 | 29 | ◎ | ○ | ◎ | ○ |
| | 8 | | | Quenched & Tempered | 300 | 32 | ◎ | | ◎ | |
| | 9 | | | Quenched & Tempered | 350 | 38 | ◎ | | ◎ | |
| | 10 | | High alloyed steel, and tool steel | | Annealed | 200 | 15 | ◎ | ○ | ◎ |
| | 11 | | | Quenched & Tempered | 325 | 35 | ◎ | | ◎ | |
| M | 12 | Stainless steel | Ferritic / Martensitic | Annealed | 200 | 15 | | ◎ | | ◎ |
| | 13 | | Martensitic | Quenched & Tempered | 240 | 23 | | ◎ | | ◎ |
| | 14 | | Austenitic | | 180 | 10 | | ◎ | | ◎ |
| K | 15 | Grey cast iron | Pearlitic / ferritic | | 180 | 10 | ◎ | | ◎ | |
| | 16 | | Pearlitic (Martensitic) | | 260 | 26 | ◎ | | ◎ | |
| | 17 | Nodular cast iron | Ferritic | | 160 | 3 | ◎ | | ◎ | |
| | 18 | | Pearlitic | | 250 | 25 | ◎ | | ◎ | |
| | 19 | | Ferritic | | 130 | | ◎ | | ◎ | |
| 20 | Malleable cast iron | Pearlitic | | 230 | 21 | ◎ | | ◎ | | |
| N | 21 | Aluminum-wrought alloy | Not Curable | | 60 | | | ○ | | ○ |
| | 22 | | Curable Hardened | | 100 | | | ○ | | ○ |
| | 23 | Aluminum-cast, alloyed | ≤ 12% Si, Not Curable | | 75 | | | ○ | | ○ |
| | 24 | | ≤ 12% Si, Curable Hardened | | 90 | | | ○ | | ○ |
| | 25 | | > 12% Si, Not Curable | | 130 | | | ○ | | ○ |
| | 26 | Copper and Copper Alloys (Bronze / Brass) | Cutting Alloys, PB>1% | | 110 | | | ○ | | ○ |
| | 27 | | CuZn, CuSnZn (Brass) | | 90 | | | ○ | | ○ |
| | 28 | | CuSn, lead-free copper and electrolytic copper | | 100 | | | ○ | | ○ |
| | 29 | | Non Metallic Materials | | | | | | | |
| | 30 | | Rubber, Wood, etc. | | | | | | | |
| S | 31 | Heat Resistant Super Alloys | Fe Based | Annealed | 200 | 15 | | | | |
| | 32 | | | Cured | 280 | 30 | | | | |
| | 33 | | Annealed | 250 | 25 | | | | | |
| | 34 | | Ni or Co Based | Cured | 350 | 38 | | | | |
| | 35 | | | Cast | 320 | 34 | | | | |
| | 36 | Titanium Alloys | Pure Titanium | | 400 Rm | | | | | |
| 37 | Alpha + Beta Alloys | | 1050 Rm | | | | | | | |
| H | 38 | Hardened steel | | | 550 | 55 | | | | |
| | 39 | | | | 630 | 60 | | | | |
| | 40 | | Chilled Cast Iron | | 400 | 42 | | | | |
| | 41 | | Hardened Cast Iron | | 550 | 55 | | | | |

| YC1A | YC2C | YD1A | YD2C | YE1A | YE2C | YF1A | YF2C | YG1A | YG2C |
|------------|------|------------|------|------------|------|------------|------|------------|------|
| C | | D | | E | | F | | G | |
| 16.00 | | 18.00 | | 20.00 | | 22.00 | | 24.00 | |
| 17.86 | | 19.84 | | 21.83 | | 23.81 | | 25.80 | |
| A46 | | A47 | | A48 | | A49 | | A50 | |
| TiAIN | TiCN | TiAIN | TiCN | TiAIN | TiCN | TiAIN | TiCN | TiAIN | TiCN |



| | | | | | | | | | | |
|---|---|---|---|---|---|---|---|---|---|------|
| ⊙ | ○ | ⊙ | ○ | ⊙ | ○ | ⊙ | ○ | ⊙ | ○ | 1 |
| ⊙ | ○ | ⊙ | ○ | ⊙ | ○ | ⊙ | ○ | ⊙ | ○ | 2 |
| ⊙ | ○ | ⊙ | ○ | ⊙ | ○ | ⊙ | ○ | ⊙ | ○ | 3 |
| ⊙ | ○ | ⊙ | ○ | ⊙ | ○ | ⊙ | ○ | ⊙ | ○ | 4 |
| ⊙ | ○ | ⊙ | ○ | ⊙ | ○ | ⊙ | ○ | ⊙ | ○ | 5 |
| ⊙ | ○ | ⊙ | ○ | ⊙ | ○ | ⊙ | ○ | ⊙ | ○ | 6 P |
| ⊙ | ○ | ⊙ | ○ | ⊙ | ○ | ⊙ | ○ | ⊙ | ○ | 7 |
| ⊙ | ○ | ⊙ | ○ | ⊙ | ○ | ⊙ | ○ | ⊙ | ○ | 8 |
| ⊙ | ○ | ⊙ | ○ | ⊙ | ○ | ⊙ | ○ | ⊙ | ○ | 9 |
| ⊙ | ○ | ⊙ | ○ | ⊙ | ○ | ⊙ | ○ | ⊙ | ○ | 10 |
| ⊙ | ○ | ⊙ | ○ | ⊙ | ○ | ⊙ | ○ | ⊙ | ○ | 11 |
| | ⊙ | | ⊙ | | ⊙ | | ⊙ | | ⊙ | 12 |
| | ⊙ | | ⊙ | | ⊙ | | ⊙ | | ⊙ | 13 M |
| | ⊙ | | ⊙ | | ⊙ | | ⊙ | | ⊙ | 14 |
| ⊙ | | ⊙ | | ⊙ | | ⊙ | | ⊙ | | 15 |
| ⊙ | | ⊙ | | ⊙ | | ⊙ | | ⊙ | | 16 |
| ⊙ | | ⊙ | | ⊙ | | ⊙ | | ⊙ | | 17 K |
| ⊙ | | ⊙ | | ⊙ | | ⊙ | | ⊙ | | 18 |
| ⊙ | | ⊙ | | ⊙ | | ⊙ | | ⊙ | | 19 |
| ⊙ | | ⊙ | | ⊙ | | ⊙ | | ⊙ | | 20 |
| | ○ | | ○ | | ○ | | ○ | | ○ | 21 |
| | ○ | | ○ | | ○ | | ○ | | ○ | 22 |
| | ○ | | ○ | | ○ | | ○ | | ○ | 23 |
| | ○ | | ○ | | ○ | | ○ | | ○ | 24 |
| | ○ | | ○ | | ○ | | ○ | | ○ | 25 N |
| | ○ | | ○ | | ○ | | ○ | | ○ | 26 |
| | ○ | | ○ | | ○ | | ○ | | ○ | 27 |
| | ○ | | ○ | | ○ | | ○ | | ○ | 28 |
| | | | | | | | | | | 29 |
| | | | | | | | | | | 30 |
| | | | | | | | | | | 31 |
| | | | | | | | | | | 32 |
| | | | | | | | | | | 33 |
| | | | | | | | | | | 34 S |
| | | | | | | | | | | 35 |
| | | | | | | | | | | 36 |
| | | | | | | | | | | 37 |
| | | | | | | | | | | 38 |
| | | | | | | | | | | 39 H |
| | | | | | | | | | | 40 |
| | | | | | | | | | | 41 |

HSS

i-ONE DRILLS

i-DREAM DRILLS

DREAM DRILLS -PRO

DREAM DRILLS -GENERAL

DREAM DRILLS -HIGH FEED

DREAM DRILLS -FLAT BOTTOM

DREAM DRILLS -INOX

DREAM DRILLS -ALU

DREAM DRILLS -MQL

DREAM DRILLS for HIGH HARDENED STEELS

GENERAL CARBIDE DRILLS

MULTI-1 DRILLS

HPD DRILLS

GOLD-P DRILLS

SUPER-GP DRILLS

STRAIGHT SHANK DRILLS

TAPER SHANK DRILLS

NC-SPOTTING DRILLS

CENTER DRILLS

SPADE DRILLS

REAMERS

COUNTER SINKS

COUNTER BORES

TECHNICAL DATA

YA1A, YB1A, YC1A, YD1A, YE1A, YF1A, YG1A, YH1A, YI1A, YJ1A SERIES

i-DREAM DRILLS - GENERAL

VC = M/MIN
RPM = rev./min.
FEED = mm/rev.

| ISO | VDI 3323 | Material Description | Vc (m/min) | Feed(mm/rev) | | | | | |
|----------|---------------------|----------------------|------------------------------------|--------------|--------------|--------------|--------------|--------------|-----------|
| | | | | Ø12.00-14.99 | Ø15.00-17.99 | Ø18.00-21.99 | Ø22.00-26.99 | Ø27.00-31.99 | |
| P | 1 | Non-alloy steel | 95-120 | 0.16-0.28 | 0.21-0.35 | 0.27-0.40 | 0.34-0.52 | 0.37-0.55 | |
| | 2 | | 80-105 | 0.14-0.24 | 0.21-0.35 | 0.27-0.40 | 0.34-0.52 | 0.37-0.55 | |
| | 3 | | 60-80 | 0.12-0.20 | 0.17-0.28 | 0.22-0.32 | 0.30-0.46 | 0.33-0.49 | |
| | 4 | | 55-70 | 0.10-0.16 | 0.15-0.25 | 0.21-0.30 | 0.25-0.38 | 0.29-0.43 | |
| | 5 | Low alloy steel | 55-70 | 0.10-0.16 | 0.15-0.25 | 0.21-0.30 | 0.25-0.38 | 0.29-0.43 | |
| | 6 | | 70-90 | 0.12-0.20 | 0.17-0.28 | 0.22-0.32 | 0.30-0.46 | 0.34-0.50 | |
| | 7 | | 60-80 | 0.12-0.20 | 0.15-0.25 | 0.22-0.32 | 0.30-0.46 | 0.34-0.50 | |
| | 8 | | 55-70 | 0.10-0.16 | 0.13-0.21 | 0.21-0.30 | 0.25-0.38 | 0.29-0.43 | |
| | 9 | | 45-60 | 0.08-0.12 | 0.13-0.21 | 0.21-0.30 | 0.25-0.38 | 0.29-0.43 | |
| | 10 | | High alloyed steel, and tool steel | 50-65 | 0.10-0.16 | 0.13-0.21 | 0.18-0.26 | 0.20-0.31 | 0.24-0.35 |
| | 11 | | | 40-55 | 0.10-0.16 | 0.11-0.18 | 0.21-0.30 | 0.20-0.31 | 0.24-0.35 |
| K | 15 | Grey cast iron | 100-125 | 0.15-0.26 | 0.20-0.37 | 0.27-0.42 | 0.36-0.51 | 0.40-0.55 | |
| | 16 | | 75-95 | 0.11-0.20 | 0.16-0.29 | 0.20-0.30 | 0.25-0.35 | 0.29-0.40 | |
| | 17 | Nodular cast iron | 95-120 | 0.13-0.22 | 0.17-0.31 | 0.21-0.32 | 0.28-0.40 | 0.32-0.44 | |
| | 18 | | 75-95 | 0.11-0.20 | 0.14-0.26 | 0.19-0.29 | 0.25-0.35 | 0.29-0.40 | |
| | 19 | | 100-125 | 0.13-0.22 | 0.17-0.31 | 0.21-0.32 | 0.28-0.40 | 0.32-0.44 | |
| 20 | Malleable cast iron | 75-95 | 0.11-0.18 | 0.14-0.26 | 0.19-0.29 | 0.25-0.35 | 0.29-0.40 | | |

- ▶ The recommendations for speeds, feeds and other parameters presented in this chart are nominal recommendations and should be considered only as good starting points.
Speed and feed reductions (20% reduction in speed and 10% reduction in feed) are recommended.
- ▶ Recommend you to reduce the feed rate to 85%, 70% when you use 5xD, 7xD holders.
- ▶ For use of 7xD holder, we recommend to use a pilot drill with equal to or larger than 140° point angle (0.5xD - 1.5xD).
The use of the centering pre-hole improves hole location, roundness and surface finish.

Comparison with Split Point Drill, Spade Drill & Dream Drill



**YA2C, YB2C, YC2C, YD2C, YE2C,
YF2C, YG2C, YH2C, YI2C, YJ2C** SERIES

i-DREAM DRILLS - INOX

 VC = m/min
 RPM = rev./min.
 FEED = mm/rev.

| ISO | VDI 3323 | Material Description | Vc (m/min) | Feed(mm/rev) | | | | | |
|----------|----------|------------------------|---|----------------|--------------|--------------|--------------|--------------|-----------|
| | | | | Ø12.00-14.99 | Ø15.00-17.99 | Ø18.00-21.90 | Ø22.00-26.99 | Ø27.00-31.99 | |
| P | 1 | Non-alloy steel | 95-120 | 0.16-0.28 | 0.21-0.35 | 0.27-0.40 | 0.34-0.52 | 0.37-0.55 | |
| | 2 | | 80-105 | 0.14-0.24 | 0.21-0.35 | 0.27-0.40 | 0.34-0.52 | 0.37-0.55 | |
| | 3 | | 60-80 | 0.12-0.20 | 0.17-0.28 | 0.22-0.32 | 0.30-0.46 | 0.33-0.49 | |
| | 4 | | 55-70 | 0.10-0.16 | 0.15-0.25 | 0.21-0.30 | 0.25-0.38 | 0.29-0.43 | |
| | 6 | Low alloy steel | 70-90 | 0.12-0.20 | 0.17-0.28 | 0.22-0.32 | 0.30-0.46 | 0.34-0.50 | |
| | 7 | | 60-80 | 0.12-0.20 | 0.15-0.25 | 0.22-0.32 | 0.30-0.46 | 0.34-0.50 | |
| | 10 | | High alloyed steel, and tool steel | 50-65 | 0.10-0.16 | 0.13-0.21 | 0.18-0.26 | 0.20-0.31 | 0.24-0.35 |
| M | 12 | Stainless steel | 30-45 | 0.08-0.14 | 0.09-0.15 | 0.10-0.16 | 0.12-0.20 | 0.14-0.22 | |
| | 13 | | 30-45 | 0.08-0.14 | 0.09-0.15 | 0.10-0.16 | 0.12-0.20 | 0.14-0.22 | |
| | 14 | | 45-60 | 0.10-0.16 | 0.12-0.18 | 0.14-0.20 | 0.15-0.26 | 0.18-0.28 | |
| N | 21 | Aluminum-wrought alloy | 250-330 | 0.30-0.40 | 0.35-0.45 | 0.40-0.50 | 0.45-0.55 | 0.50-0.60 | |
| | 22 | | 200-250 | 0.30-0.40 | 0.35-0.45 | 0.40-0.50 | 0.45-0.55 | 0.50-0.60 | |
| | 23 | Aluminum-cast, alloyed | 200-250 | 0.25-0.35 | 0.30-0.40 | 0.35-0.45 | 0.40-0.50 | 0.45-0.55 | |
| | 24 | | 150-220 | 0.25-0.35 | 0.30-0.40 | 0.35-0.45 | 0.40-0.50 | 0.45-0.55 | |
| | 25 | | 100-200 | 0.20-0.30 | 0.25-0.35 | 0.30-0.40 | 0.35-0.45 | 0.40-0.50 | |
| | 26 | | Copper and Copper Alloys (Bronze / Brass) | 115-145 | 0.16-0.28 | 0.23-0.36 | 0.29-0.36 | 0.37-0.45 | 0.41-0.48 |
| | 27 | | | 145-185 | 0.17-0.29 | 0.24-0.37 | 0.30-0.38 | 0.38-0.46 | 0.42-0.49 |
| | 28 | | | 95-120 | 0.06-0.09 | 0.09-0.13 | 0.11-0.13 | 0.15-0.18 | 0.19-0.22 |

- ▶ The recommendations for speeds, feeds and other parameters presented in this chart are nominal recommendations and should be considered only as good starting points.
Speed and feed reductions (20% reduction in speed and 10% reduction in feed) are recommended.
- ▶ Recommend you to reduce the feed rate to 85%, 70% when you use 5xD, 7xD holders.
- ▶ For use of 7xD holder, we recommend to use a pilot drill with equal to or larger than 140° point angle (0.5xD - 1.5xD).
The use of the centering pre-hole improves hole location, roundness and surface finish.

TEST I GENERAL

Cutting Condition

| | |
|---------------|---|
| HOLDER | ZH14505020 |
| INSERT | YB1A1450 / Ø14.5 |
| Work Material | - ASTM : A36 - DIN : St37-2 - JIS : SS400 |
| Cutting Speed | 80 m/min |
| Feed | 0.24 mm/rev. |
| Feedrate | 421 mm/min. |
| RPM | 1,756 rev./min. |
| Drilling | 48.0 mm |
| Coolant | Internal |
| Machine type | Vertical Machining Center |

RESULT

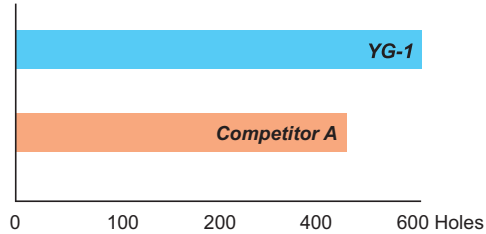

► YG-1 (Total Drilling 600 Holes)

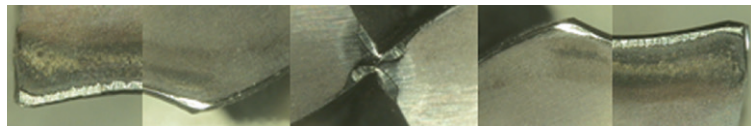

► Competitor A (Total Drilling 470 Holes)



TEST II INOX

Cutting Condition

| | |
|---------------|---|
| HOLDER | ZH14005020 |
| INSERT | YB2C1400 / Ø14.0 |
| Work Material | - AISI : 304 - DIN : X5CrNi189 - JIS : SUS304 |
| Cutting Speed | 55 m/min |
| Feed | 0.15 mm/rev. |
| Feedrate | 188 mm/min. |
| RPM | 1,250 rev./min. |
| Drilling | 50.0 mm |
| Coolant | Internal |
| Machine type | Vertical Machining Center |

RESULT

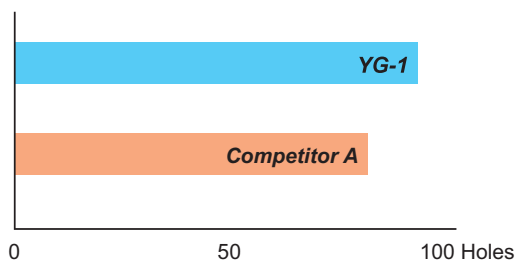

► YG-1 (Total Drilling 100 Holes)

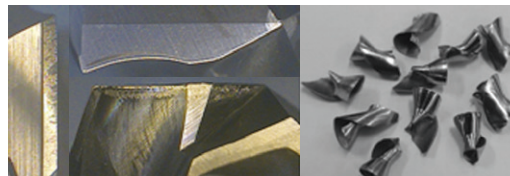

► Competitor A (Total Drilling 80 Holes)

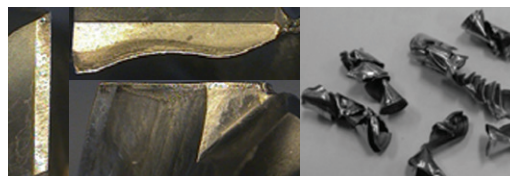

ASSEMBLY OF *i*-DREAM DRILLS
MONTAGE DES *i*-DREAM DRILLS





Make sure to clean the insert and insert seat.
Schneideinsatz und Haltersitz sorgfältig reinigen.



Slide the drill insert into the slot of the holder and press down the insert to touch the bottom of the slot.
Schneideinsatz in den Haltersitz einführen und den Schneideinsatz fest auf den Grund des Haltersitzes pressen.



After confirming the insert is pressed down to the bottom of the slot, tighten the screw using anti-seize compound.
Wenn der Schneideinsatz fest auf den Grund des Haltersitzes gepresst ist, die Schraube fest anziehen und dabei Spezialfett verwenden.

| WRENCH TYPE | PRODUCT NO. | T-HANDLE No. | SERIES (SIZE) |
|--|-------------|--------------|-------------------------|
|  <p>WING TYPE</p> | TWWT08 | — | A (Ø12.00-Ø13.99) |
| | | | B (Ø14.00-Ø15.99) |
| | | | C (Ø16.00-Ø17.99) |
|  <p>TORX BIT TYPE</p> | TWBT15 | TWH600 | D (Ø18.00-Ø19.99) |
| | TWBT20 | | E, F, G (Ø20.00-Ø25.99) |
| | TWBT25 | | H, I, J (Ø26.00-Ø31.99) |

Use the wing type or T-type wrench.
Benutzen Sie den Winkeldreher oder T - Schlüsse

- ▶ Need to use appropriate wrenches and screws as indicated.
Unbedingt die angegebenen Schrauben und Dreher verwenden.
- ▶ It's important to tighten up the screw properly.
Es ist wichtig, die Schraube korrekt und fest anzuziehen.

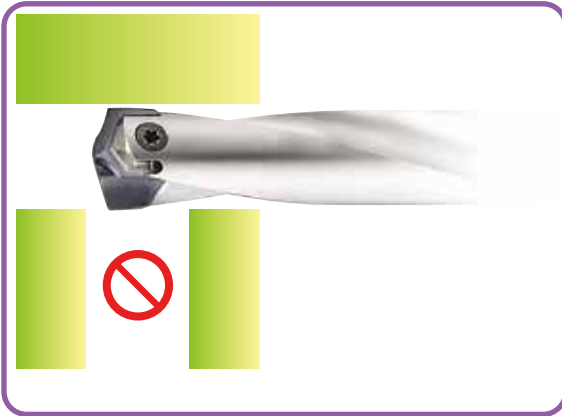
CAUTION-NOT RECOMMENDABLE APPLICATION
ACHTUNG - NICHT EMPFOHLENE ANWENDUNG

Intersecting cross hole is bigger than the drill insert's Margin Length.

Der Haltersitz ist größer als die Breite des Schneideinsatzes.

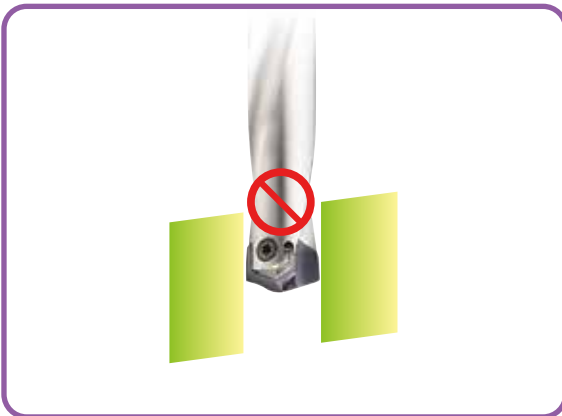

Material with slanting entrance and exit over 7 degrees. (If drilling 7 degrees or under slanting surface, reduce the feed about 30-50%)

Werkstücke mit schrägem Anschnitt oder Austritt von über 7°. (Zum Bohren von bis zu 7° Schräge den Vorschub um ca. 30-50% reduzieren).

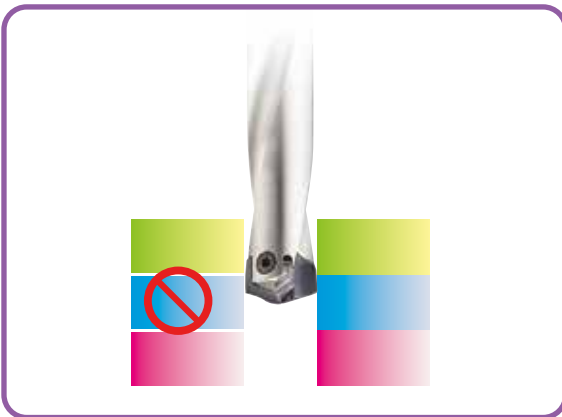

For drilling stacked plates, minimize the space between the plates.

Beim Bohren von Blechpaketen den Abstand der Bleche minimieren.

The space between stacked plates can cause insert breakage or poor chip control.

Freiraum in Blechpaketen kann den Bruch des Schneideinsatzes oder schlechte Entspannung verursachen.

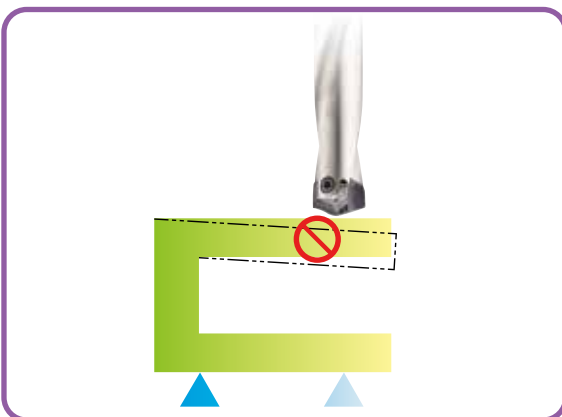

The material needs to be fixtured securely before drilling.

Das Werkstück muss fest und sicher aufgespannt sein

RECOMMENDED COOLANT PRESSURE AND FLOW RATE ON VERTICAL DRILLING
EMPFOHLENE KÜHLMITTELDRUCK UND - MENGE BEIM VERTIKALEN BOHREN

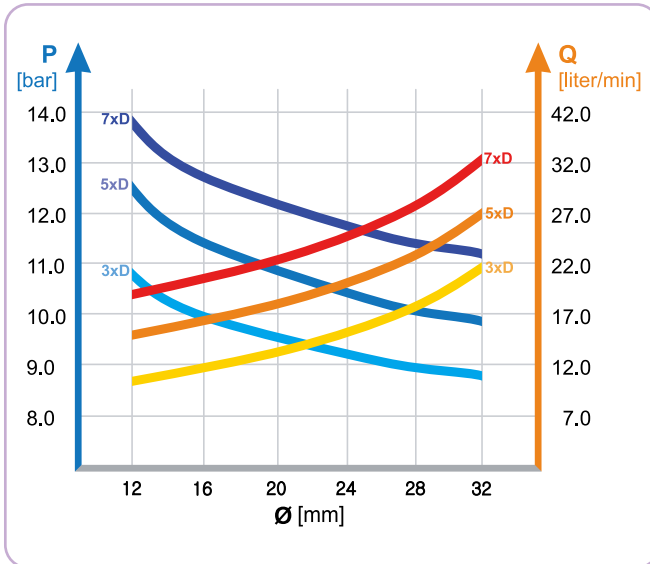

- Recommended emulsion mix is 6 - 8%.
Empfohlene Emulsionsmischung 6 - 8%.
- For Drilling into Stainless and High Strength steels, a mix of 10% is recommended.
Beim Bohren in rostfreie und hochfeste Stähle werden 10% empfohlen.
- For horizontal drilling, 30% reduction on the coolant pressure and flow rate is possible.
Beim horizontalen Bohren können Kühlmitteldruck und -menge um 30% gemindert werden.
- Dry drilling is possible for 1-2xD drilling. But not recommended.
Trocken Bohren ist möglich bei 1-2xD. Aber nicht empfohlen.

TROUBLE SHOOTING
PROBLEMLÖSUNGEN



- 1) Heavy flank wear / Fast flank wear**
- Reduce cutting speed
 - Increase feed



- 2) Chipping on cutting edge**
- Reduce feed
 - Check the rigidity of spindle and chuck
 - Rigid clamping of workpiece



- 3) Build-up on cutting edge**
- Increase cutting speed
 - Use a coated insert



- 4) Chipping or break down on outer corner**
- Reduce feed
 - Rigid clamping of workpiece



- 5) Wear of land margin**
- Rigid clamping of workpiece
 - Reduce cutting speed
 - Increase coolant flow

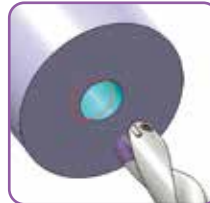

- 6) Unsatisfactory positioning of the hole**
- Rigid clamping of workpiece
 - Reduce feed during entrance or exit



- 7) Scratching on holder**
- Rigid clamping of workpiece
 - Reduce feed
 - Increase coolant flow

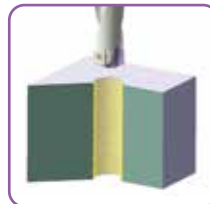

- 8) Unsatisfactory surface finish**
- Rigid clamping of workpiece
 - Increase coolant flow and pressure