

Milling - High Feed Milling - Cutter
Cutters for WNE X

Entering Angle : 90°
 3 Corner Positive

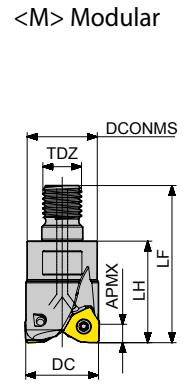
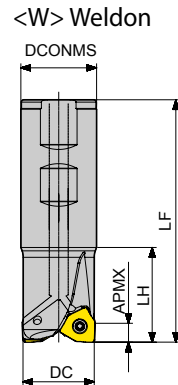
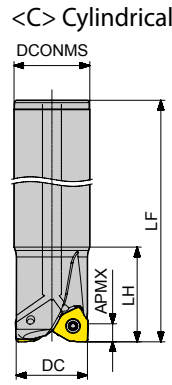
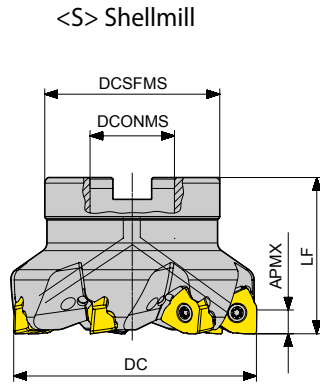

CICT : Number of Inserts
 CBDP : Connection Bore Depth

□: p.175

Unit : mm

Series	APMX	Designation	EDP 1700..	DC	CICT	LF	TYPE	DCON / TDZ	LH	CBDP	DCSFMS	●
WNE X 0806	7.0	E90 - WN08 - D32Z2W32 - L120	0969	32	2	120	Weldon	32	40	-	-	●
		E90 - WN08 - D40Z3W32 - L120	0972	40	3	120		32	40	-	-	●
		E90 - WN08 - D40Z4W32 - L120	0973	40	4	120		32	40	-	-	●
		E90 - WN08 - D50Z4W32 - L120	0974	50	4	120		32	40	-	-	●
		E90 - WN08 - D50Z5W32 - L120	0990	50	5	120		32	40	-	-	●
		E90 - WN08 - D32Z2C32 - L120	0991	32	2	120	Cylindrical	32	40	-	-	●
		E90 - WN08 - D32Z2C32 - L200	0872	32	2	200		32	60	-	-	●
		E90 - WN08 - D33Z2C32 - L200	0873	33	2	200		32	40	-	-	●
		E90 - WN08 - D40Z3C32 - L120	0994	40	3	120		32	40	-	-	●
		E90 - WN08 - D40Z3C32 - L200	0874	40	3	200		32	40	-	-	●
		E90 - WN08 - D40Z4C32 - L120	0996	40	4	120		32	40	-	-	●
		E90 - WN08 - D50Z4C32 - L120	0997	50	4	120		32	40	-	-	●
		E90 - WN08 - D50Z5C32 - L120	0998	50	5	120	32	40	-	-	●	
		F90 - WN08 - D50Z4S22	0875	50	4	40	Shellmill	22	-	20	44	●
		F90 - WN08 - D50Z5S22	0976	50	5	40		22	-	20	44	●
		F90 - WN08 - D63Z5S22	0876	63	5	40		22	-	20	48	●
		F90 - WN08 - D63Z6S22	0977	63	6	40		22	-	20	48	●
		F90 - WN08 - D80Z4S27	0999	80	4	50		27	-	20	56	●
		F90 - WN08 - D80Z6S25.4	1000	80	6	50		25.4	-	26.64	56	●
		F90 - WN08 - D80Z7S27	0878	80	7	50		27	-	23	56	●
F90 - WN08 - D80Z7S25.4	0877	80	7	50	25.4	-		26.64	56	●		
F90 - WN08 - D80Z9S27	0978	80	9	50	27	-		23	56	●		
F90 - WN08 - D100Z8S31.75 - WOC	1002	100	8	50	31.75	-		32	67	X		
F90 - WN08 - D100Z9S32	0979	100	9	50	32	-	26	67	●			
F90 - WN08 - D100Z11S32	0980	100	11	50	32	-	26	67	●			
F90 - WN08 - D125Z10S38.1 - WOC	1003	125	10	63	38.1	-	38	85	X			
F90 - WN08 - D125Z11S40	0981	125	11	63	40	-	29	85	●			
F90 - WN08 - D125Z14S40	0982	125	14	63	40	-	29	85	●			
M90 - WN08 - D32Z2M16	1004	32	2	65	Modular	M16	42	-	29	●		
M90 - WN08 - D40Z3M16	1005	40	3	65		M16	42	-	29	●		
M90 - WN08 - D40Z4M16	0984	40	4	65		M16	42	-	29	●		

* Clamping Torque (Nm) 3.0Nm

WNE X0806	Screw	Wrench	Handle	BIT
Description	TP154011-GS	TPWBTP15	DH-H4	DB-TP15
EDP	18000251	18000217	18000189	18000208

Code Keys - Milling Cutters

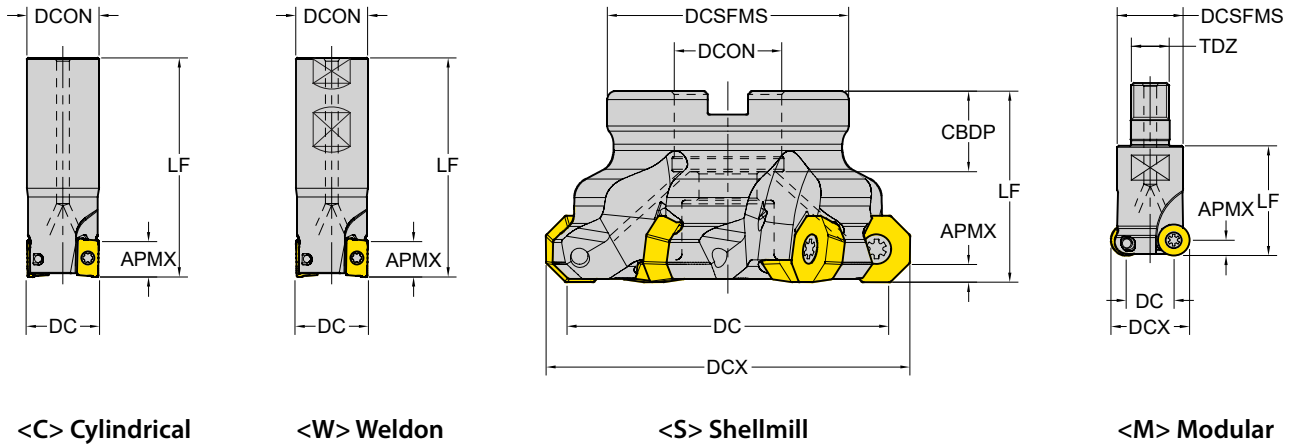

Entering Cutting Angle
(90°)

Cutter Diameter
(Ø16)

Connection Type and Size
C - Cylindrical W - Weldon
S - Shellmill M - Modular
(Cylindrical Ø16)

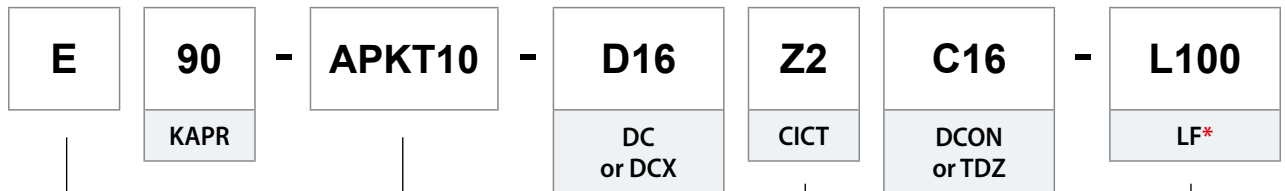

Cutter Type
E - Endmill Type
F - Facemill Type
M - Modular Type

Insert Series
(APKT 10)

Number of Teeth
(Z=2)





Functional Length
(100mm)

Milling Cutters Overview

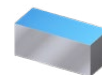
Mounting Bolt : p. 197

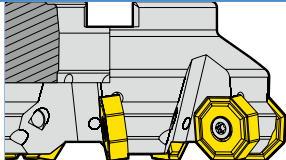
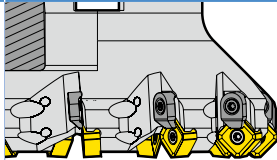
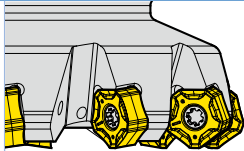

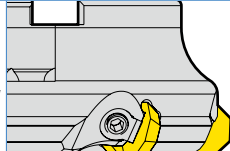
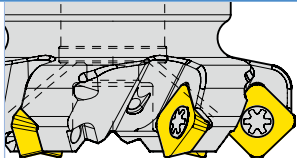
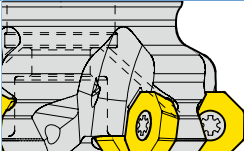

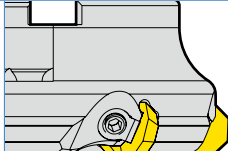

Face Milling

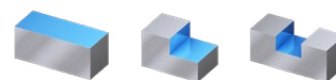

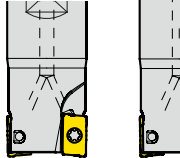
Negative Octagonal		Negative Square		
Cutter	 ONMU 0806	 SNMX 1206		
APMX	5.5		6	
DC	Ø63~315		Ø50~200	
page	185		192	
Negative 10 Corner		Positive Octagonal		
Cutter	 PNMU 1206	 ODMT/ODMW 0605	 OFER 0704	
APMX	4	3.5	5	
DC	Ø50~125	Ø63~125	Ø63~160	
page	186	184	184	
Positive Square			ISO	
Cutter	 SEKT 1204	 SEKT 12T3	 SEGT 1204	 SPKN/SPKR/SPCN 1203
APMX	6	6	6	8
DC	Ø40~160	Ø50~160	Ø50~160	Ø50~200
page	190	190	190	191

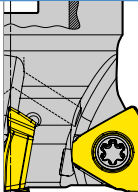
Shoulder Milling



2 Corner Positive		ISO		
Cutter	 	 APKT 1003	 APKT 1604	
APMX		9	14	
DC		Ø16~100	Ø25~200	
page		178-179	180-181	
3 Corner Positive		ISO		
Cutter	 TPKT 1104 NEW	 TPKT 1605 NEW	 TPKN/TPKR/TPCN 1603	 TPKN/TPKR/TPCN 2204
APMX	7.0	11.0	12	18
DC	20~63	32~200	Ø50~125	Ø63~315
page	194	195	193	193

TURNING

PARTING & GROOVING

MILLING

DRILLING

TECHNICAL INFORMATION

Click/Touch each page number and move to the very page!

Milling Cutters Overview

Mounting Bolt : p. 197

Shoulder Milling

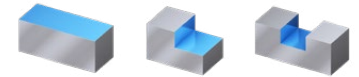

6 Corner Negative

Cutter		NEW WNEWX0806
APMX		7
DC		Ø32~125
page		196

Profiling

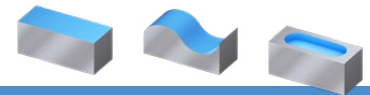

Round Positive

Cutter		
		0802 10T3 1204
APMX		4 5 6
DCX		Ø16~25 Ø20~63 Ø25~100
page		187 187 188

High Feed Milling

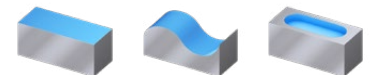

Negative 4 Corner

Positive 4 Corner

Cutter				
		ENMX 0604 ENMX 0604 ENMX 0905		SDMT/SDMW 1204
APMX		0.9 1 1.5		1.8
DCX		Ø16~18 Ø20~50 Ø25~125		Ø32~100
page		182 182 183		189

Modular Shank

Modular Shank for Modular Head

Cutter		M08 ~ M16
page		197