

M Solid Carbide Miniature Thread Mill for Hard Materials, ISO Metric Internal Thread - DIN13

● VOLLHARTMETALL MINI-GEWINDEFÄHRER für GEHÄRTETE MATERIALIEN, ISO METRISCHE INNENGEWINDE - DIN13
● FRAISES À TOURBILLONNER CARBURE MONOBLOC POUR MATÉRIAUX DURS, FILETAGE ISO INTER MÉTRIQUE - DIN13
● Mini frese per acciai temprati ISO metriche passo grosso - DIN 13

- ▶ Short thread length
- ▶ Straight Flute
- ▶ Left hand Cut (CNC code : M04)
- ▶ The work direction is from top to bottom (Climb Milling)
- ▶ For hard materials up to HRc62

- ▶ Kurze Gewindelänge
- ▶ Linksschneidend, geradegenutet
- ▶ Linksschneidend (CNC Befehl : M04)
- ▶ Die Fräsrichtung ist von oben nach unten (Gleichlauf)
- ▶ Für gehärtete Materialien bis zu HRc62

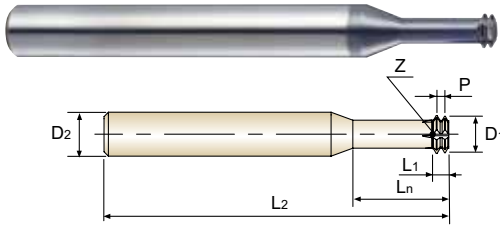

Thread Depth
2×D

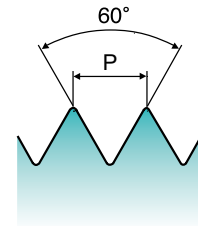

Recommended ToolHolder	Flat Shank		Plain Shank	
	Page	Page	Page	Page
⊙	END MILL HOLDER	D117 - 137	HYDRAULIC CHUCK SHRINK FIT HOLDER	D15 - 46 D47 - 72
⊙	POWER MILLING CHUCK			D161 - 176
○	ER COLLET CHUCK SK SLIM CHUCK			D73 - 115 D183 - 201

Unit : mm

EDP No.	Nominal Diameter [D]	Pitch P	Cutter Diameter D1	Shank Diameter D2	Thread Length L1	Neck Length Ln	Overall Length L2	No. of Flute Z
L19E1130	M2	0.4	1.52	6	0.8	4.2	57	4
L19E1150	M2.2	0.45	1.66	6	0.9	4.6	57	4
L19E1170	M2.5	0.45	1.96	6	0.9	5.3	57	4
L19E1200	M3	0.5	2.4	6	1.0	6.3	57	4
L19E1240	M4	0.7	3.16	6	1.4	8.4	57	4
L19E1280	M5	0.8	4.04	6	1.6	10.5	57	4
L19E1310	M6	1.0	4.8	6	2.0	12.6	57	5
L19E1360	M8	1.25	6.5	8	2.5	16.8	63	5
L19E1420	M10	1.5	8.2	10	3.0	21.0	73	6
L19E1500	M12	1.75	9.9	10	3.5	25.2	73	6

* Other coatings are available on your request

⊙ : Excellent ○ : Good

ISO Material Description	P					M					K																							
	Non-alloy steel					Low alloy steel					High alloyed steel, and tool steel					Stainless steel					Grey cast iron					Nodular cast iron					Malleable cast iron			
VDI 3323	1	2	3	4	5	6	7	8	9	10	11	12	13	14	15	16	17	18	19	20	21	22	23	24	25	26	27	28	29	30	31	32		
HRc	125	130	140	150	160	170	180	190	200	210	220	230	240	250	260	270	280	290	300	310	320	330	340	350	360	370	380	390	400	410	420	430		
HB	125	130	140	150	160	170	180	190	200	210	220	230	240	250	260	270	280	290	300	310	320	330	340	350	360	370	380	390	400	410	420	430		
Recommended	⊙	⊙	⊙	⊙	⊙	⊙	⊙	⊙	⊙	⊙	⊙	⊙	⊙	⊙	⊙	⊙	⊙	⊙	⊙	⊙	⊙	⊙	⊙	⊙	⊙	⊙	⊙	⊙	⊙	⊙	⊙	⊙		

ISO Material Description	N					S					H																																	
	Aluminum-wrought alloy					Aluminum-cast, alloyed					Copper and Copper Alloys (Bronze / Brass)					Non Metallic Materials					Heat Resistant Super Alloys					Titanium Alloys					Hardened steel					Chilled Cast Iron					Hardened Cast Iron			
VDI 3323	21	22	23	24	25	26	27	28	29	30	31	32	33	34	35	36	37	38	39	40	41	42	43	44	45	46	47	48	49	50	51	52	53											
HRc	60	100	120	140	160	180	200	220	240	260	280	300	320	340	360	380	400	420	440	460	480	500	520	540	560	580	600	620	640	660	680	700	720											
HB	60	100	120	140	160	180	200	220	240	260	280	300	320	340	360	380	400	420	440	460	480	500	520	540	560	580	600	620	640	660	680	700	720											
Recommended	⊙	⊙	⊙	⊙	⊙	⊙	⊙	⊙	⊙	⊙	⊙	⊙	⊙	⊙	⊙	⊙	⊙	⊙	⊙	⊙	⊙	⊙	⊙	⊙	⊙	⊙	⊙	⊙	⊙	⊙	⊙	⊙												

SELECTION GUIDE



THREADING TOOLS

THREAD MILLS









TYPE	Thread Mill without Coolant Hole				Thread Mill with Coolant Hole		
	M	MF	UNC	UNF	M	MF	BSP(G)
THREAD FORM							
HOLE TYPE	Max. 2.0xD Blind /Through Hole	Max. 1.5xD Blind /Through Hole	Max. 2.0xD Blind /Through Hole	Max. 2.0xD Blind /Through Hole	Max. 2.0xD Blind /Through Hole	Max. 1.5xD Blind /Through Hole	-
TOOL MATERIAL	CARBIDE						
FLUTE TYPE	Helix						
HELIX ANGLE	R15						
SERIES NO.	L1211 (p.B34)	L1212 (p.B35)	L1213 (p.B36)	L1214 (p.B37)	L4211 (p.B38)	L4212 (p.B39)	L6215 (p.B40)
SURFACE TREATMENT	TiAIN	TiAIN	TiAIN	TiAIN	TiAIN	TiAIN	TiAIN
MODEL							

Please visit globalyg1.com/mat for material search

◎ : Excellent ○ : Good

ISO	VDI 3323	Material Description	HB	HRC	L1211	L1212	L1213	L1214	L4211	L4212	L6215
P	1	Non-alloy steel	125		◎	◎	◎	◎	◎	◎	◎
	2		190	13	◎	◎	◎	◎	◎	◎	◎
	3		250	25	◎	◎	◎	◎	◎	◎	◎
	4		270	28	◎	◎	◎	◎	◎	◎	◎
	5	Low alloy steel	300	32	◎	◎	◎	◎	◎	◎	◎
	6		180	10	◎	◎	◎	◎	◎	◎	◎
	7		275	29	◎	◎	◎	◎	◎	◎	◎
	8	High alloyed steel, and tool steel	300	32	◎	◎	◎	◎	◎	◎	◎
	9		350	38	◎	◎	◎	◎	◎	◎	◎
	10		200	15	◎	◎	◎	◎	◎	◎	◎
	11		325	35	◎	◎	◎	◎	◎	◎	◎
M	12	Stainless steel	200	15	○	○	○	○	○	○	○
	13		240	23	○	○	○	○	○	○	○
	14		180	10	○	○	○	○	○	○	○
K	15	Grey cast iron	180	10	◎	◎	◎	◎	◎	◎	◎
	16		260	26	◎	◎	◎	◎	◎	◎	◎
	17	Nodular Cast Iron	160	3	◎	◎	◎	◎	◎	◎	◎
	18		250	25	◎	◎	◎	◎	◎	◎	◎
	19	Malleable cast iron	130		◎	◎	◎	◎	◎	◎	◎
	20		230	21	◎	◎	◎	◎	◎	◎	◎
N	21	Aluminum-wrought alloy	60		◎	◎	◎	◎	◎	◎	◎
	22		100		◎	◎	◎	◎	◎	◎	◎
	23	Aluminum-cast, alloyed	75		◎	◎	◎	◎	◎	◎	◎
	24		90		◎	◎	◎	◎	◎	◎	◎
	25		130		◎	◎	◎	◎	◎	◎	◎
	26	Copper and Copper Alloys	110		◎	◎	◎	◎	◎	◎	◎
	27		90		◎	◎	◎	◎	◎	◎	◎
	28	Bronze / Brass	100		◎	◎	◎	◎	◎	◎	◎
	29					◎	◎	◎	◎	◎	◎
30	Non Metallic Materials			◎	◎	◎	◎	◎	◎	◎	
S	31	Heat Resistant Super Alloys	200	15	○	○	○	○	○	○	○
	32		280	30	○	○	○	○	○	○	○
	33		250	25	○	○	○	○	○	○	○
	34		350	38	○	○	○	○	○	○	○
	35		320	34	○	○	○	○	○	○	○
	36	Titanium Alloys	400 Rm		○	○	○	○	○	○	○
	37		1050 Rm		○	○	○	○	○	○	○
H	38	Hardened steel	550	55							
	39		630	60							
	40	Chilled Cast Iron	400	42							
	41	Hardened Cast Iron	550	55							

THREAD MILLS

Thread Mill with Coolant Hole & Chamfer					Miniature Thread Mill		Miniature Thread Mill for Hard Materials		Drill & Thread Mill with Chamfer
M	MF	UNC	UNF	NPT	M	UNC	M	UNC	M
Max. 2.0xD  Blind/Through Hole	Max. 1.5xD  Blind/Through Hole	Max. 2.0xD  Blind/Through Hole	Max. 2.0xD  Blind/Through Hole	-	Max. 2.0xD  Blind/Through Hole	Max. 2.0xD  Blind/Through Hole	Max. 2.0xD  Blind/Through Hole	Max. 2.0xD  Blind/Through Hole	Max. 2.0xD  Blind/Through Hole

CARBIDE

Helix					Helix		Straight		Helix
R15					R15		—		R25
L4271 (p.B41)	L4272 (p.B42)	L4273 (p.B43)	L4274 (p.B44)	L4276 (p.B45)	L12D1 (p.B46)	L12D3 (p.B47)	L19E1 (p.B48)	L19E3 (p.B49)	L41A1 / L42A1 (p.B50)
TiAIN	TiAIN	TiAIN	TiAIN	TiAIN	TiAIN	TiAIN	AlTiN	AlTiN	Bright / TiAIN

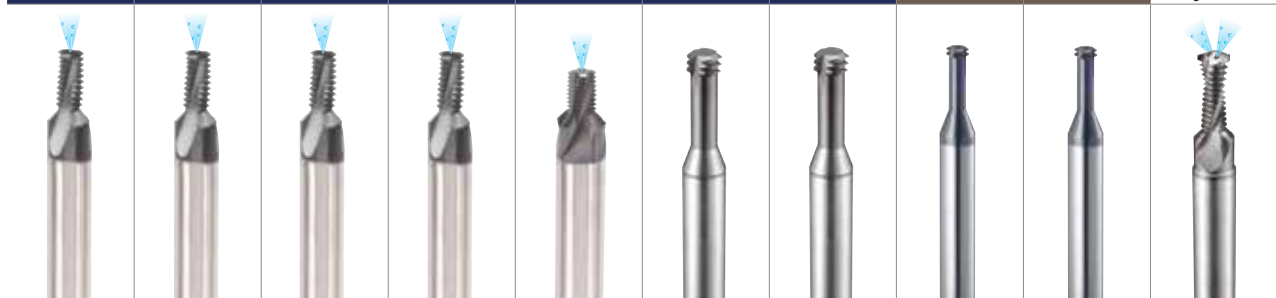

○	○	○	○	○	○	○				1
○	○	○	○	○	○	○				2
○	○	○	○	○	○	○				3
○	○	○	○	○	○	○				4
○	○	○	○	○	○	○				5
○	○	○	○	○	○	○	○	○		6 P
○	○	○	○	○	○	○	○	○		7
○	○	○	○	○	○	○	○	○		8
○	○	○	○	○	○	○	○	○		9
○	○	○	○	○	○	○	○	○		10
○	○	○	○	○	○	○	○	○		11
○	○	○	○	○	○	○	○	○		12
○	○	○	○	○	○	○	○	○		13 M
○	○	○	○	○	○	○	○	○		14
○	○	○	○	○	○	○	○	○	○	15
○	○	○	○	○	○	○	○	○	○	16
○	○	○	○	○	○	○	○	○	○	17 K
○	○	○	○	○	○	○	○	○	○	18
○	○	○	○	○	○	○	○	○	○	19
○	○	○	○	○	○	○	○	○	○	20
○	○	○	○	○	○	○			○	21
○	○	○	○	○	○	○			○	22
○	○	○	○	○	○	○			○	23
○	○	○	○	○	○	○			○	24
○	○	○	○	○	○	○			○	25
○	○	○	○	○	○	○			○	26 N
○	○	○	○	○	○	○			○	27
○	○	○	○	○	○	○			○	28
○	○	○	○	○	○	○			○	29
○	○	○	○	○	○	○			○	30
○	○	○	○	○	○	○	○	○		31
○	○	○	○	○	○	○	○	○		32
○	○	○	○	○	○	○	○	○		33
○	○	○	○	○	○	○	○	○		34 S
○	○	○	○	○	○	○	○	○		35
○	○	○	○	○	○	○	○	○		36
○	○	○	○	○	○	○	○	○		37
							○	○		38
							○	○		39 H
							○	○		40
							○	○		41

HSS

THREAD MILLS

SYNCHRO TAPS

PRIME TAPS

COMBO TAPS

YG TAP GENERAL

YG TAP STEEL

YG TAP HARDENED

YG TAP INOX

YG TAP CAST IRON

YG TAP ALU

YG TAP Ti Ni

YG TAP FORMING

NUT TAPS

STI TAPS

PIPE TAPS

TECHNICAL DATA

ISO	VDI 3323	Material Description	HB	HRc	L4273	L4274	L4276	L12D1	L12D3	L19E1	L19E3	L41A1 L42A1
					Vc (m/min)							
P	1	Non-alloy steel	125		80-120	80-120	80-120	80-120	80-120			
	2		190	13	80-120	80-120	80-120	80-120	80-120			
	3		250	25	80-120	80-120	80-120	80-120	80-120			
	4		270	28	80-120	80-120	80-120	80-120	80-120			
	5		300	32	80-120	80-120	80-120	80-120	80-120			
	6	Low alloy steel	180	10	80-120	80-120	80-120	80-120	80-120	80-120	80-120	
	7		275	29	80-120	80-120	80-120	80-120	80-120	80-120	80-120	
	8		300	32	80-120	80-120	80-120	80-120	80-120	80-120	80-120	
	9		350	38	80-120	80-120	80-120	80-120	80-120	80-120	80-120	
	10	High alloyed steel, and tool steel	200	15	80-120	80-120	80-120	80-120	80-120	80-120	80-120	
	11		325	35	80-120	80-120	80-120	80-120	80-120	80-120	80-120	
M	12	Stainless steel	200	15	40-80	40-80	40-80	40-80	40-80	40-80	40-80	
	13		240	23	40-80	40-80	40-80	40-80	40-80	40-80	40-80	
	14		180	10	40-80	40-80	40-80	40-80	40-80	40-80	40-80	
K	15	Grey cast iron	180	10	50-100	50-100	50-100	50-100	50-100	50-100	50-100	80-150
	16		260	26	50-100	50-100	50-100	50-100	50-100	50-100	50-100	80-150
	17	Nodular cast iron	160	3	50-100	50-100	50-100	50-100	50-100	50-100	50-100	80-150
	18		250	25	50-100	50-100	50-100	50-100	50-100	50-100	50-100	80-150
	19	Malleable cast iron	130		50-100	50-100	50-100	50-100	50-100	50-100	50-100	80-150
20	230		21	50-100	50-100	50-100	50-100	50-100	50-100	50-100	80-150	
N	21	Aluminum-wrought alloy	60		100-300	100-300	100-300	100-300	100-300			100-300
	22		100		100-300	100-300	100-300	100-300	100-300			100-300
	23	Aluminum-cast, alloyed	75		100-300	100-300	100-300	100-300	100-300			100-300
	24		90		100-300	100-300	100-300	100-300	100-300			100-300
	25		130		100-300	100-300	100-300	100-300	100-300			100-300
	26		110		100-300	100-300	100-300	100-300	100-300			100-300
	27	Copper and Copper Alloys (Bronze / Brass)	90		100-300	100-300	100-300	100-300	100-300			100-300
	28		100		100-300	100-300	100-300	100-300	100-300			100-300
	29	Non Metallic Materials			100-300	100-300	100-300	100-300	100-300			80-150
	30				100-300	100-300	100-300	100-300	100-300			80-150
S	31	Heat Resistant Super Alloys	200	15	20-60	20-60	20-60	20-60	20-60	20-60	20-60	
	32		280	30	20-60	20-60	20-60	20-60	20-60	20-60	20-60	
	33		250	25	20-60	20-60	20-60	20-60	20-60	20-60	20-60	
	34		350	38	20-60	20-60	20-60	20-60	20-60	20-60	20-60	
	35		320	34	20-60	20-60	20-60	20-60	20-60	20-60	20-60	
	36	Titanium Alloys	400Rm		20-60	20-60	20-60	20-60	20-60	20-60	20-60	
	37		1050Rm		20-60	20-60	20-60	20-60	20-60	20-60	20-60	
H	38	Hardened steel	550	55						25-60	25-60	
	39		630	60						25-50	25-50	
	40	Chilled Cast Iron	400	42						25-70	25-70	
	41	Hardened Cast Iron	550	55						25-60	25-60	

CARBIDE

HSS

THREAD MILLS

SYNCHRO TAPS

PRIME TAPS

COMBO TAPS

YG TAP GENERAL

YG TAP STEEL

YG TAP HARDENED

YG TAP INOX

YG TAP CAST IRON

YG TAP ALU

YG TAP Ti Ni

YG TAP FORMING

NUT TAPS

STI TAPS

PIPE TAPS

TECHNICAL DATA

TO CALCULATE SPEED & FEED RATES

SCHNITTGESCHWINDIGKEIT & VORSCHUB KALKULIEREN

Calculate R.P.M of Cutter	Calculate Feed per Revolution	Finally Calculate Feed at Tool Center Line
$n = \frac{1000 \times V}{d \times \pi}$	$F_1 = F_z \times Z \times N$	$F_2 = \frac{F_1 \times (D - d)}{D}$

- N** RPM
- V** Recommended Cutting Speed
- d** Diameter of Cutter
- Fz** Recommended Feed per Tooth
- Z** Number of Teeth
- F2** Feed at Center Line of Cutting
- F1** Feed at Cutting Edge
- D** Major Diameter of Component

SURFACE TREATMENT AND COATING

The applied High Speed Steels holds a grant of good wear resistance and toughness. Therefore YG-1 normally delivers taps with bright and unfinished surface. For certain materials, various surface treatments provide higher advantage in machining.

STEAM TEMPERED - Vap

Steam Tempered is a Fe₃O₄-oxyd-coating which reduces friction between the tool and workpiece, also preventing cold welding.

NITRIDING - NI

Recommend surface treatment for machining materials that affect wear abrasion, such as grey cast iron, alu-alloys with high Si-percentages (more than 10%).

Below are the various surface treatments for excellent finish surfaces suitable for many applications. The surface treatments are produced and developed within the company.

TiN-COATING

TiN-coating yields a hardness of approx. 2,300 HV and also a heat resistant up to approx. 600°C. The current coating is an excellent all-round coating for normal applications.

Colour : Golden Coefficient of friction against steel : 0.4

TiCN-COATING

TiCN takes place of TiN when the conditions require the coating to have a different hardness and toughness.

The TiCN brings advantages for machining very difficult steels or cutting interrupted bores.

The TiCN-coating has a hardness of approx. 3,000 HV, but is heat resistance only holds up to approx. 400°C, meaning that the TiCN needs an excellent cooling system for a long service life.

Colour : Blue-Grey Coefficient of friction against steel : 0.4

TiAlN-COATING

A special coating for machining abrasive materials such as grey cast iron, alu-alloys with silicon, fiber reinforced plastics, etc., or machining at high temperatures with insufficient cooling, or at high speeds $\geq 600\text{m/min}$. TiAlN has a hardness of approx. 3,000 HV and is heat resistant up to approx. 800°C.

Colour : Violet-Grey Coefficient of friction against steel : 0.4

Hardslick-COATING

Hardslick combines the advantages of an extremely hard, thermally stable TiAlN-coating with the sliding and lubricating properties of an outer WC/C(Tungsten carbide/carbon)-coating in a novel way. The Hardslick coating has a hardness of approx. 3,000 HV and is temperature-resistant up to approx. 800°C.

Colour : Violet-Grey Coefficient of friction against steel : 0.2

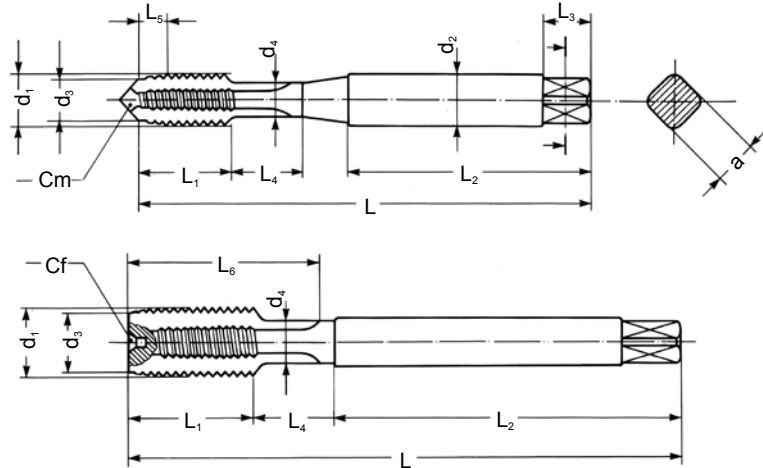
TAPS TERMINOLOGY
FACHAUSDRÜCKE BEI GEWINDEBOHRERN (Terminologie)

d_1 Major diameter
 d_2 Shank diameter
 d_3 Chamfer diameter
 d_4 Neck diameter
 L Total length
 L_1 Thread length
 L_2 Shank length
 L_3 Square length
 L_4 Neck length
 L_5 Chamfer length
 L_6 Flutes length
 a Square
 Cm Center male
 Cf Center female

d_1 Nenn Aussendurchmesser
 d_2 Schaftdurchmesser
 d_3 Anschnittdurchmesser
 d_4 Bunddurchmesser
 L Gesamtlänge
 L_1 Gewindelänge
 L_2 Schaftlänge
 L_3 Vierkantlänge
 L_4 Bundlänge
 L_5 Anschnittlänge
 L_6 Nutenlänge
 a Vierkantmaß β
 Cm Mittelpunkt des Aussengewindes
 Cf Mittelpunkt des Innengewindes

d_1 Diamètre externe nominal
 d_2 Diamètre de la queue
 d_3 Diamètre de l'entrée
 d_4 Diamètre de la collerette de dégagement
 L Longueur totale
 L_1 Longueur de la partie filetée
 L_2 Longueur de la queue
 L_3 Longueur du carré
 L_4 Longueur de la collerette de dégagement
 L_5 Longueur de l'entrée
 L_6 Longueur des goujures
 a Carré
 Cm Centre mâle
 Cf Centre femelle

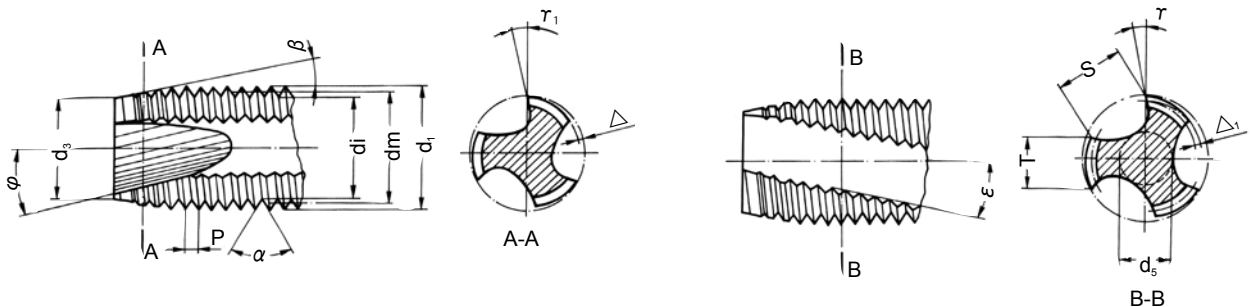

d_1 Major diameter
 dm Flank diameter
 d_i Minor diameter
 d_3 Chamfer diameter
 P Pitch
 a Flank angle
 β Chamfer angle
 φ Gun nose angle
 τ Gun nose rake angle in front
 Δ Chamfer relief
 Δ_1 Pitch diameter relief on the land
 τ Rake angle
 T Width of land
 S Flute width
 d_5 Web thickness
 ε Angle of spiral flute

d_1 Nenn Aussendurchmesser
 dm Flankendurchmesser
 d_i Kerndurchmesser
 d_3 Anschnittdurchmesser
 P Steigung
 a Flankenwinkel
 β Anschnittwinkel
 φ Schälsschnittwinkel
 τ_1 Schälsschnitt-Spanwinkel
 Δ Hinterschliff am Anschnitt
 Δ_1 Flankenhinterschliff auf Zahnbreite
 τ Spanwinkel
 T Zahnstollenbreite
 S Nutenbreite
 d_5 Seelendicke
 ε Spiralwinkel

d_1 Diamètre externe nominal
 dm Diamètre moyen
 d_i Diamètre interne
 d_3 Diamètre de l'entrée
 P Pas
 a Angle du filet
 β Demi-angle du cône d'entrée
 φ Angle de l'entrée GUN
 τ_1 Angle de coupe sur l'entrée GUN
 Δ Détalonnage sur l'entrée
 Δ_1 Détalonnage sur le filet
 τ Angle de coupe frontale
 T Largeur des dents
 S Largeur des goujures
 d_5 Diamètre de l'âme
 ε Angle d'hélice des goujures

**RECOMMENDED TAP DRILL SIZE
EMPFOHLENE KERNLOCHMASSE**

Unit : mm

Metric-ISO threads coarse pitch				Metric-ISO threads fine pitch				Metric-ISO threads fine pitch			
M	Pitch	Maximum core dia.	Drill size	MF	Pitch	Maximum core dia.	Drill size	MF	Pitch	Maximum core dia.	Drill size
1	0.25	0.785	0.75	2.5	0.35	2.221	2.15	25	2.00	23.210	23.00
1.1	0.25	0.885	0.85	3	0.35	2.271	2.65	26	1.50	24.676	24.50
1.2	0.25	0.985	0.95	3.5	0.35	3.221	3.15	27	1.00	26.153	26.00
1.4	0.30	1.160	1.10	4	0.50	3.599	3.50	27	1.50	25.676	25.50
1.6	0.35	1.321	1.25	4.5	0.50	4.099	4.00	27	2.00	25.210	25.00
1.7	0.35	1.346	1.30	5	0.50	4.599	4.50	28	1.00	27.153	27.00
1.8	0.35	1.521	1.45	5.5	0.50	5.099	5.00	28	1.50	26.676	26.50
2	0.40	1.679	1.60	6	0.75	5.378	5.20	28	2.00	26.210	26.00
2.2	0.45	1.838	1.75	7	0.75	6.378	6.20	30	1.00	29.153	29.00
2.3	0.40	1.920	1.90	8	0.75	7.378	7.20	30	1.50	28.676	28.50
2.5	0.45	2.138	2.05	8	1.00	7.153	7.00	30	2.00	28.210	28.00
2.6	0.45	2.176	2.10	9	0.75	8.378	8.20	30	3.00	27.252	27.00
3	0.50	2.599	2.50	9	1.00	8.153	8.00	32	1.50	30.675	30.50
3.5	0.60	3.010	2.90	10	0.75	9.378	9.20	32	2.00	30.210	30.00
4	0.70	3.422	3.30	10	1.00	9.153	9.00	33	1.50	31.676	31.50
4.5	0.75	3.878	3.70	10	1.25	8.912	8.80	33	2.00	31.210	31.00
5	0.80	4.334	4.20	11	0.75	10.378	10.20	33	3.00	30.252	30.00
6	1.00	5.153	5.00	11	1.00	10.153	10.00	35	1.50	33.676	33.50
7	1.00	6.153	6.00	12	1.00	11.153	11.00	36	1.50	34.676	34.50
8	1.25	6.912	6.80	12	1.25	10.912	10.80	36	2.00	34.210	34.00
9	1.25	7.912	7.80	12	1.50	10.676	10.50	36	3.00	33.252	33.00
10	1.50	8.676	8.50	14	1.00	13.153	13.00	38	1.50	36.676	36.50
11	1.50	9.676	9.50	14	1.25	12.912	12.80	39	1.50	37.676	37.50
12	1.75	10.441	10.20	14	1.50	12.676	12.50	39	2.00	37.210	37.00
14	2.00	12.210	12.00	15	1.00	14.153	14.00	39	3.00	36.252	36.00
16	2.00	14.210	14.00	15	1.50	13.676	13.50	40	1.50	38.676	38.50
18	2.50	15.744	15.50	16	1.00	15.153	15.00	40	2.00	38.210	38.00
20	2.50	17.744	17.50	16	1.50	14.676	14.50	40	3.00	37.252	37.00
22	2.50	19.744	19.50	17	1.00	16.153	16.00	42	1.50	40.676	40.50
24	3.00	21.252	21.00	17	1.50	15.676	15.50	42	2.00	40.210	40.00
27	3.00	24.252	24.00	18	1.00	17.153	17.00	42	3.00	39.252	39.00
30	3.50	26.771	26.50	18	1.50	16.676	16.50	45	1.50	43.676	43.50
33	3.50	29.771	29.50	18	2.00	16.210	16.00	45	2.00	43.210	43.00
36	4.00	32.270	32.00	20	1.00	19.153	19.00	45	3.00	42.252	42.00
39	4.00	35.270	35.00	20	1.50	18.676	18.50	48	1.50	46.676	46.50
42	4.50	37.799	37.50	20	2.00	18.210	18.00	48	2.00	46.210	46.00
45	4.50	40.799	40.50	22	1.00	21.153	21.00	48	3.00	45.252	45.00
48	5.00	43.297	43.00	22	1.50	20.676	20.50	50	1.50	48.676	48.50
52	5.00	47.297	47.00	22	2.00	20.210	20.00	50	2.00	48.210	48.00
56	5.50	50.796	50.50	24	1.00	23.153	23.00	50	3.00	47.252	47.00
60	5.50	54.796	54.50	24	1.50	22.676	22.50	52	1.50	50.676	50.50
64	6.00	58.305	58.00	24	2.00	22.210	22.00	52	2.00	50.210	50.00
68	6.00	62.305	62.00	25	1.00	24.153	24.00	52	3.00	49.252	49.00
				25	1.50	23.676	23.50				



Unit : mm

	American Unified coarse threads				American Unified fine threads			
	UNC	T.P.I	Maximum core dia.	Drill size	UNF	T.P.I	Maximum core dia.	Drill size
	#1	64	1.585	1.50	#0	80	1.306	1.30
	#2	56	1.872	1.80	#1	72	1.613	1.60
	#3	48	2.146	2.10	#2	64	1.913	1.90
COMBO TAPS	#4	40	2.385	2.30	#3	56	2.197	2.10
	#5	40	2.697	2.60	#4	48	2.459	2.40
	#6	32	2.896	2.85	#5	44	2.741	2.70
YG TAP GENERAL	#8	32	3.528	3.50	#6	40	3.012	3.00
	#10	24	3.950	3.90	#8	36	3.597	3.50
YG TAP STEEL	#12	24	4.590	4.50	#10	32	4.168	4.10
	1/4"	20	5.250	5.20	#12	28	4.717	4.70
	5/16"	18	6.680	6.60	1/4"	28	5.563	5.50
YG TAP HARDENED	3/8"	16	8.082	8.00	5/16"	24	6.995	6.90
	7/16"	14	9.441	9.40	3/8"	24	8.565	8.50
	1/2"	13	10.881	10.75	7/16"	20	9.947	9.90
YG TAP INOX	9/16"	12	12.301	12.25	1/2"	20	11.524	11.50
	5/8"	11	13.693	13.50	9/16"	18	12.969	12.90
	3/4"	10	16.624	16.50	5/8"	18	14.554	14.50
YG TAP CAST IRON	7/8"	9	19.520	19.50	3/4"	16	17.546	17.50
	1"	8	22.344	22.25	7/8"	14	20.493	20.50
	1*1/8"	7	25.082	25.00	1"	12	23.363	23.25
YG TAP ALU	1*1/4"	7	28.258	28.25	1*1/8"	12	26.538	26.50
	1*3/8"	6	30.851	30.75	1*1/4"	12	29.713	29.50
YG TAP Ti Ni	1*1/2"	6	34.026	34.00	1*3/8"	12	32.888	32.70
	1*3/4"	5	39.560	39.50	1*1/2"	12	36.063	36.00
YG TAP FORMING	2"	4.5	45.367	45.25				

	Whitworth threads B.S.W.				Whitworth pipe thread BSP.PI			
	BSW	T.P.I	Maximum core dia.	Drill size	G(BSP)	T.P.I	Maximum core dia.	Drill size
	3/32"	48	1.910	1.80	1/8"	28	8.848	8.80
NUT TAPS	1/8"	40	2.590	2.50	1/4"	19	11.890	11.80
STI TAPS	5/32"	32	3.211	3.10	3/8"	19	15.395	15.25
PIPE TAPS	3/16"	24	3.743	3.60	1/2"	14	19.172	19.00
	7/32"	24	4.538	4.40	5/8"	14	21.128	21.00
	1/4"	20	5.224	5.10	3/4"	14	24.658	24.50
	5/16"	18	6.661	6.50	7/8"	14	28.418	28.25
	3/8"	16	8.052	7.90	1"	11	30.931	30.75
	7/16"	14	9.379	9.30	1*1/8"	11	35.579	35.50
	1/2"	12	10.610	10.50	1*1/4"	11	39.592	39.50
	9/16"	12	12.176	12.00	1*3/8"	11	42.005	42.00
	5/8"	11	13.598	13.50	1*1/2"	11	45.485	45.20
	3/4"	10	16.538	16.50	1*5/8"	11	49.670	49.60
	7/8"	9	19.411	19.25	1*3/4"	11	51.428	51.40
	1"	8	22.185	22.00	2"	11	57.296	57.20
	1*1/8"	7	24.879	24.75	2*1/4"	11	63.392	63.30
	1*1/4"	7	28.054	27.75	2*3/8"	11	67.080	67.00
	1*3/8"	6	30.555	30.50	2*1/2"	11	72.866	72.80
	1*1/2"	6	33.730	33.50	2*3/4"	11	79.216	79.10
	1*5/8"	5	35.921	35.50	3"	11	85.566	85.50
	1*3/4"	5	39.096	39.00	3*1/4"	11	91.662	91.50
	1*7/8"	4.5	41.648	41.50	3*1/2"	11	98.012	98.00
	2"	4.5	44.823	44.50	3*3/4"	11	104.362	104.00
	2*1/4"	4	50.420	50.00	4"	11	110.712	110.50
	2*1/2"	4	56.770	56.50				
	2*3/4"	3.5	62.108	62.00				
	3"	3.5	68.459	68.50				