



Vap	TB844 SERIES
Bright	TC844 SERIES
TiN	TD844 SERIES

MF ISO Metric fine threads DIN 13

- MF** Metrisches ISO-Feingewinde DIN 13
- ISO MÉTRIQUE PAS FINS DIN13
- ISO Metrico passo fine DIN 13

► For using multi-purpose and correct thread profiles & long tool life due to special tap geometry. YG-1 company has a patent.

► Für vielfältigen Einsatz, genaue Gewindeprofile und lange Standzeitendank einer besonderen Schneidengeometrie. Von YG-1 patentiert.

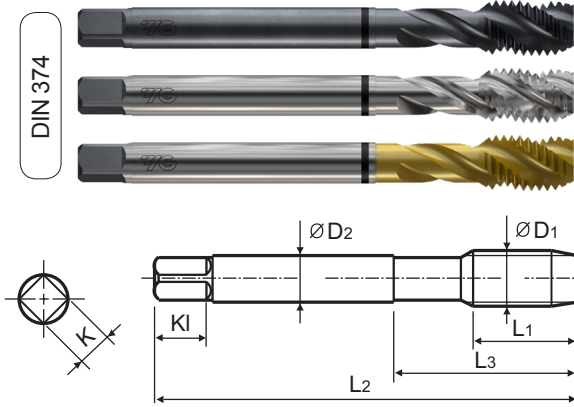

Hole type
2.5×D

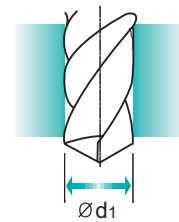
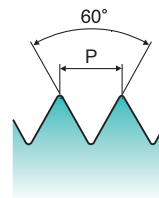
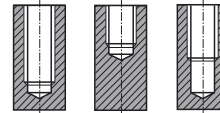

Machine taps
Maschinengewindebohrer

Recommended Cutting Page : P.114

Unit : mm

SIZE	Pitch	EDP No.			Thread Length	Overall Length	Neck Length	Shank Diameter	Square Size	Square Length	No. of Flute	Tapping Drill Diameter
		Vap	Bright	TiN								
ØD1	P	L1	L2	L3	ØD2	K	KI	Z	Ød1			
M4 × 0.5		TB844256	TC844256	TD844256	5	63	21	2.8	2.1	5	3	3.5
M5 × 0.5		TB844296	TC844296	TD844296	5	70	25	3.5	2.7	6	3	4.5
M6 × 0.75		TB844326	TC844326	TD844326	8	80	30	4.5	3.4	6	3	5.2
M6 × 0.5		TB844336	TC844336	TD844336	5	80	30	4.5	3.4	6	3	5.5
M7 × 0.75		TB844356	TC844356	TD844356	10	80	30	5.5	4.3	7	3	6.2
M8 × 1		TB844376	TC844376	TD844376	10	90	36	6	4.9	8	3	7
M8 × 0.75		TB844386	TC844386	TD844386	8	80	30	6	4.9	8	3	7.2
M10 × 1.25		TB844436	TC844436	TD844436	16	100	40	7	5.5	8	3	8.8
M10 × 1		TB844446	TC844446	TD844446	10	90	36	7	5.5	8	3	9
M10 × 0.75		TB844456	TC844456	TD844456	10	90	36	7	5.5	8	3	9.2
M12 × 1.5		TB844516	TC844516	TD844516	15	100	40	9	7	10	3	10.5
M12 × 1.25		TB844526	TC844526	TD844526	15	100	40	9	7	10	3	10.8
M12 × 1		TB844536	TC844536	TD844536	11	100	40	9	7	10	3	11
M14 × 1.5		TB844556	TC844556	TD844556	15	100	40	11	9	12	3	12.5
M14 × 1.25		TB844566	TC844566	TD844566	15	100	40	11	9	12	3	12.8
M14 × 1		TB844576	TC844576	TD844576	11	100	40	11	9	12	3	13
M16 × 1.5		TB844616	TC844616	TD844616	15	100	40	12	9	12	3	14.5
M16 × 1		TB844626	TC844626	TD844626	12	100	40	12	9	12	3	15
M18 × 1.5		TB844676	TC844676	TD844676	17	110	44	14	11	14	4	16.5
M18 × 1		TB844686	TC844686	TD844686	13	110	44	14	11	14	4	17
M20 × 1.5		TB844726	TC844726	TD844726	17	125	50	16	12	15	4	18.5
M20 × 1		TB844736	TC844736	TD844736	14	125	50	16	12	15	4	19
M22 × 1.5		TB844766	TC844766	TD844766	17	125	50	18	14.5	17	4	20.5
M22 × 1		TB844776	TC844776	TD844776	14	125	50	18	14.5	17	4	21

* The other coating(TiCN or TiAlN) is available on your request.

► NEXT PAGE

◎ : Excellent ○ : Good

ISO	P										M				K					
	Non-alloy steel					Low alloy steel					High alloyed steel, and tool steel		Stainless steel		Grey cast iron		Nodular cast iron		Malleable cast iron	
VDI 3323	1	2	3	4	5	6	7	8	9	10	11	12	13	14	15	16	17	18	19	20
HRc	13	25	28	32	32	10	29	32	38	15	35	15	23	10	10	26	3	25		21
HB	125	190	250	270	300	180	275	300	350	200	325	200	240	180	180	260	160	250	130	230
Recommended	○	◎	◎	◎	◎	◎	◎	◎	◎	○	○	◎	◎	◎	◎	◎	◎	◎		

ISO	N					S										H					
	Aluminum-wrought alloy		Aluminum-cast, alloyed			Copper and Copper Alloys (Bronze / Brass)			Non Metallic Materials		Heat Resistant Super Alloys					Titanium Alloys		Hardened steel	Chilled Cast Iron	Hardened Cast Iron	
VDI 3323	21	22	23	24	25	26	27	28	29	30	31	32	33	34	35	36	37	38	39	40	41
HRc											15	30	25	38	34			55	60	42	55
HB	60	100	75	90	130	110	90	100			200	280	250	350	320	400Rm	1050Rm	550	630	400	550
Recommended			◎			◎	◎	◎													



Vap **TB844** SERIES
 Bright **TC844** SERIES
 TiN **TD844** SERIES

MF ISO Metric fine threads DIN 13

Metrisches ISO-Feingewinde DIN 13
 ISO MÉTRIQUE PAS FINS DIN13
 ISO Metrico passo fine DIN 13

► For using multi-purpose and correct thread profiles & long tool life due to special tap geometry. YG-1 company has a patent.

► Für vielfältigen Einsatz, genaue Gewindeprofile und lange Standzeit dank einer besonderen Schneidengeometrie. Von YG-1 patentiert.



Hole type
2.5×D

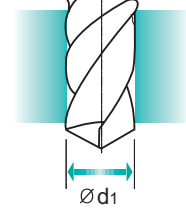
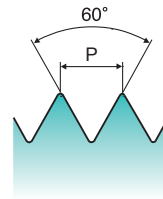
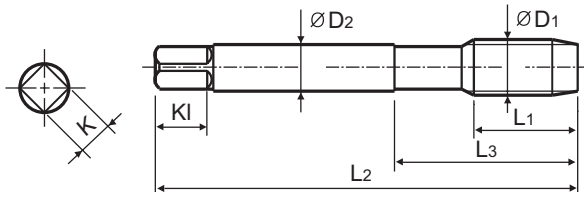
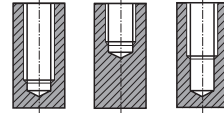

Material groups **MU** HSS-E DIN 374 6H 60° C Vap Bright TiN R40

Machine taps
Maschinengewindebohrer

Recommended Cutting Page : P.114

Unit : mm

SIZE	Pitch	EDP No.			Thread Length	Overall Length	Neck Length	Shank Diameter	Square Size	Square Length	No. of Flute	Tapping Drill Diameter
		Vap	Bright	TiN								
M24 × 2		TB844796	TC844796	TD844796	20	140	54	18	14.5	17	4	22
M24 × 1.5		TB844806	TC844806	TD844806	20	140	54	18	14.5	17	4	22.5
M26 × 1.5		TB844856	TC844856	TD844856	20	140	54	18	14.5	17	4	24.5
M27 × 2		TB844876	TC844876	TD844876	20	140	54	20	16	19	4	25
M27 × 1.5		TB844886	TC844886	TD844886	20	140	54	20	16	19	4	25.5
M28 × 1.5		TB844916	TC844916	TD844916	20	140	54	20	16	19	4	26.5
M30 × 2		TB844966	TC844966	TD844966	22	150	57	22	18	21	4	28
M30 × 1.5		TB844976	TC844976	TD844976	22	150	57	22	18	21	4	28.5

* The other coating(TiCN or TiAlN) is available on your request.

◎ : Excellent ○ : Good

ISO	P										M				K						
	Non-alloy steel					Low alloy steel					High alloyed steel, and tool steel		Stainless steel		Grey cast iron		Nodular cast iron		Malleable cast iron		
VDI 3323	1	2	3	4	5	6	7	8	9	10	11	12	13	14	15	16	17	18	19	20	
HRc	13	25	28	32	32	10	29	32	38	15	35	15	23	10	10	26	3	25		21	
HB	125	190	250	270	300	180	275	300	350	200	325	200	240	180	180	260	160	250	130	230	
Recommended	○	◎	◎	◎	◎	◎	◎	◎	◎	○	○	◎	◎	◎	◎	◎	◎	◎			
ISO	N									S						H					
	Aluminum-wrought alloy		Aluminum-cast, alloyed			Copper and Copper Alloys (Bronze / Brass)		Non Metallic Materials		Heat Resistant Super Alloys						Titanium Alloys		Hardened steel	Chilled Cast Iron	Hardened Cast Iron	
VDI 3323	21	22	23	24	25	26	27	28	29	30	31	32	33	34	35	36	37	38	39	40	41
HRc											15	30	25	38	34			55	60	42	55
HB	60	100	75	90	130	110	90	100			200	280	250	350	320	400Rm	1050Rm	550	630	400	550
Recommended			◎			◎	◎	◎													



COMBO TAPS

RECOMMENDED CUTTING CONDITIONS
EMPFOHLENE SCHNEIDKONDITIONEN

THREAD MILLS	SYNCHRO TAPS	COMBO TAPS	ISO	VDI 3323	Material Description	HB	HRc	TC804	TD804	TB804	TCE05	TDE05	TBE05	TCE06	TDE06	
								TC844	TD844	TB844	TCE09	TDE09				
								TC824	TD824	TB824	TCE01	TDE01				
								TC864	TD864	TB864	TCE02	TDE02				
								Vc (m/min)								
YG TAP GENERAL	P	1	Non-alloy steel	125		15-20	20-25	15-20	15-20	15-20	20-25	15-20	15-20	20-25		
		2		190	13	15-20	20-25	15-20	15-20	20-25	15-20	15-20	20-25			
		3		250	25	12-18	18-24	12-18	12-18	18-24	12-18	12-18	18-24			
		4		270	28	10-15	15-20	10-15	10-15	15-20	10-15	10-15	15-20			
		5		300	32	6-10	10-14	6-10	6-10	10-14	6-10	6-10	10-14			
		6	Low alloy steel	180	10	10-15	15-20	10-15	10-15	15-20	10-15	10-15	15-20			
		7		275	29	10-15	15-20	10-15	10-15	15-20	10-15	10-15	15-20			
		8		300	32	6-10	10-14	6-10	6-10	10-14	6-10	6-10	10-14			
		9		350	38	3-5	5-7	3-5	3-5	5-7	3-5	3-5	5-7			
		10		High alloyed steel, and tool steel	200	15	3-5	5-7	3-5	3-5	5-7	3-5	3-5	5-7		
		11			325	35										
YG TAP CAST IRON	M	12	Stainless steel	200	15	7-10	10-15	7-10	7-10	10-15	7-10	7-10	10-15			
		13		240	23	5-8	8-11	5-8	5-8	8-11	5-8	5-8	8-11			
		14		180	10	4-6	6-8	4-6	4-6	6-8	4-6	4-6	6-8			
YG TAP ALU	K	15	Grey cast iron	180	10	10-15	15-20	10-15	10-15	15-20	10-15	10-15	15-20			
		16		260	26	5-8	8-11	5-8	5-8	8-11	5-8	5-8	8-11			
		17	Nodular cast iron	160	3	10-15	15-20	10-15	10-15	15-20	10-15	10-15	15-20			
		18		250	25	5-8	8-11	5-8	5-8	8-11	5-8	5-8	8-11			
		19		130												
20	Malleable cast iron	230	21													
NUT TAPS	N	21	Aluminum-wrought alloy	60												
		22		100												
		23	Aluminum-cast, alloyed	75		15-20	20-25	15-20	15-20	20-25	15-20	15-20	20-25			
		24		90												
		25		130												
		26	Copper and Copper Alloys (Bronze / Brass)	110		25-35	35-40	25-35	25-35	35-40	25-35	25-35	35-40			
		27		90		8-12	12-17	8-12	8-12	12-17	8-12	8-12	12-17			
		28		100		15-20	20-25	15-20	15-20	20-25	15-20	15-20	20-25			
		29	Non Metallic Materials													
		30														
PIPE TAPS	S	31	Heat Resistant Super Alloys	200	15											
		32		280	30											
		33		250	25											
		34		350	38											
		35		320	34											
		36	Titanium Alloys	400 Rm												
		37		1050 Rm												
TECHNICAL DATA	H	38	Hardened steel	550	55											
		39		630	60											
		40	Chilled Cast Iron	400	42											
		41	Hardened Cast Iron	550	55											

SURFACE TREATMENT AND COATING

The applied High Speed Steels holds a grant of good wear resistance and toughness. Therefore YG-1 normally delivers taps with bright and unfinished surface. For certain materials, various surface treatments provide higher advantage in machining.

STEAM TEMPERED - Vap

Steam Tempered is a Fe₃O₄-oxyd-coating which reduces friction between the tool and workpiece, also preventing cold welding.

NITRIDING - NI

Recommend surface treatment for machining materials that affect wear abrasion, such as grey cast iron, alu-alloys with high Si-percentages (more than 10%).

Below are the various surface treatments for excellent finish surfaces suitable for many applications. The surface treatments are produced and developed within the company.

TiN-COATING

TiN-coating yields a hardness of approx. 2,300 HV and also a heat resistant up to approx. 600°C. The current coating is an excellent all-round coating for normal applications.

Colour : Golden Coefficient of friction against steel : 0.4

TiCN-COATING

TiCN takes place of TiN when the conditions require the coating to have a different hardness and toughness.

The TiCN brings advantages for machining very difficult steels or cutting interrupted bores.

The TiCN-coating has a hardness of approx. 3,000 HV, but is heat resistance only holds up to approx. 400°C, meaning that the TiCN needs an excellent cooling system for a long service life.

Colour : Blue-Grey Coefficient of friction against steel : 0.4

TiAlN-COATING

A special coating for machining abrasive materials such as grey cast iron, alu-alloys with silicon, fiber reinforced plastics, etc., or machining at high temperatures with insufficient cooling, or at high speeds ≥ 600 m/min. TiAlN has a hardness of approx. 3,000 HV and is heat resistant up to approx. 800°C.

Colour : Violet-Grey Coefficient of friction against steel : 0.4

Hardslick-COATING

Hardslick combines the advantages of an extremely hard, thermally stable TiAlN-coating with the sliding and lubricating properties of an outer WC/C(Tungsten carbide/carbon)-coating in a novel way. The Hardslick coating has a hardness of approx. 3,000 HV and is temperature-resistant up to approx. 800°C.

Colour : Violet-Grey Coefficient of friction against steel : 0.2

SELECTION GUIDE



HSS-E & HSS-PM COMBO TAPS

For Multi Purpose Tapping
YG-1's Patent

HOLE TYPE		Max. 2.5xD Blind Hole						
TOOL MATERIAL		HSS-E						
CHAMFER LEAD ACC. TO DIN2197		C	C	C	C	C	C	
FLUTE TYPE		Spiral Flute	Spiral Flute	Spiral Flute	Spiral Flute	Spiral Flute	Spiral Flute	
SPIRAL FLUTE ANGLE		R40	R40	R40	R40	R40	R40	
SERIES	M	DIN371/376	TC804 (P.76)	TD804 (P.76)	TB804 (P.76)	TCE05 (P.77)	TDE05 (P.77)	TBE05 (P.77)
		DIN352						
		DIN357/LONG						
	MF	DIN374	TC844 (P.81)	TD844 (P.81)	TB844 (P.81)	TCE09 (P.83)	TDE09 (P.83)	
		DIN2181						
	UNC	DIN371/376	TC824 (P.91)	TD824 (P.91)	TB824 (P.91)	TCE01 (P.92)	TDE01 (P.92)	
		DIN351						
	UNF	DIN371/374	TC864 (P.93)	TD864 (P.93)	TB864 (P.93)	TCE02 (P.94)	TDE02 (P.94)	
		DIN2181						
	BSW	DIN2182/2183						
		DIN351						
	G(BSP)	DIN5156/5157						
	EG-M	DIN371/376						
	EG-UNC	DIN371/376						
EG-UNF	DIN371/374							
SURFACE TREATMENT		Bright	TiN	VAP	Bright	TiN	VAP	
MODEL								



Please visit
globalyg1.com/mat
for material search

◎ : Excellent ○ : Good

Recommended cutting conditions : P.114

ISO	VDI 3323	Material Description	Composition / Structure / Heat Treatment	HB	HRC	Bright	TiN	VAP	Bright	TiN	VAP	
P	1	Non-alloy steel	About 0.15% C Annealed	125		○	○	○	○	○	○	
	2		About 0.45% C Annealed	190	13	◎	◎	◎	◎	◎	◎	
	3		About 0.45% C Quenched & Tempered	250	25	◎	◎	◎	◎	◎	◎	
	YG TAP Ti Ni	4	Non-alloy steel	About 0.75% C Annealed	270	28	◎	◎	◎	◎	◎	◎
		5		About 0.75% C Quenched & Tempered	300	32	◎	◎	◎	◎	◎	◎
	YG TAP FORMING	6	Low alloy steel	Annealed	180	10	◎	◎	◎	◎	◎	◎
		7		Quenched & Tempered	275	29	◎	◎	◎	◎	◎	◎
		8		Quenched & Tempered	300	32	◎	◎	◎	◎	◎	◎
		9		Quenched & Tempered	350	38	◎	◎	◎	◎	◎	◎
	NUT TAPS	10	High alloyed steel, and tool steel	Annealed	200	15	○	○	○	○	○	○
		11		Quenched & Tempered	325	35						
M	12	Stainless steel	Ferritic / Martensitic Annealed	200	15	◎	◎	◎	◎	◎	◎	
	13		Martensitic Quenched & Tempered	240	23	◎	◎	◎	◎	◎	◎	
	14		Austenitic	180	10	◎	◎	◎	◎	◎	◎	
K	15	Grey cast iron	Pearlitic / ferritic	180	10	◎	◎	◎	◎	◎	◎	
	16		Pearlitic (Martensitic)	260	26	◎	◎	◎	◎	◎	◎	
	17	Nodular cast iron	Ferritic	160	3	◎	◎	◎	◎	◎	◎	
	18		Pearlitic	250	25	◎	◎	◎	◎	◎	◎	
	19		Ferritic	130								
20	Malleable cast iron	Pearlitic	230	21								
N	21	Aluminum-wrought alloy	Not Curable	60								
	22		Curable Hardened	100								
	23	Aluminum-cast, alloyed	≤ 12% Si, Not Curable	75		◎	◎	◎	◎	◎	◎	
	24		≤ 12% Si, Curable Hardened	90								
	25		> 12% Si, Not Curable	130								
	26	Copper and Copper Alloys (Bronze / Brass)	Cutting Alloys, PB>1%	110		◎	◎	◎	◎	◎	◎	
	27		CuZn, CuSnZn (Brass)	90		◎	◎	◎	◎	◎	◎	
	28		CuSn, lead-free copper and electrolytic copper	100		◎	◎	◎	◎	◎	◎	
	29	Non Metallic Materials	Duroplastic, Fiber Reinforced Plastic									
	30		Rubber, Wood, etc.									
S	31	Heat Resistant Super Alloys	Fe Based Annealed	200	15							
	32		Cured	280	30							
	33		Annealed	250	25							
	34		Ni or Co Based Cured	350	38							
	35	Cast	320	34								
	36	Titanium Alloys	Pure Titanium	400 Rm								
	37		Alpha + Beta Alloys Hardened	1050 Rm								
H	38	Hardened steel	Hardened	550	55							
	39		Hardened	630	60							
	40	Chilled Cast Iron	Cast	400	42							
	41	Hardened Cast Iron	Hardened	550	55							