









SC = SQUARE 90° POSITIVE

QUADRADA 90° POSITIVA | ESCUADRA 90° POSITIVA

			P						M						K			N		S						
			CVD-MT				PVD		CVD-MT				PVD		UNC	CVD-MT		UNC	PVD							
			new grades																							
			(2) Grade code																							
			L7	R2	L8	R3	L9	V5	G1	G4	L7	U4	L8	U5	L9	V6	G1	G4	25	L5	L6	L9	10	G1	G4	
Inserts Pastilhas Plaquitas	(1) Geometry code	ISO Reference	PH5115	PHG115	PH5125	PHG125	PH5740	PHG140	PH7910	PH7920	PH5115	PHS215	PH5125	PHS225	PH5740	PHS240	PH7910	PH7920	PH0705	PH5705	PH5320	PH5740	PH0910	PH7910	PH7920	
 SCMW Finishing	1120469	SCMW 09T304																		⊗						
	1120470	SCMW 09T308																		⊗						
	1120471	SCMW 120404																		○						
	1120472	SCMW 120408																		⊗						
	1121424	SCMW 120412																		○						
 SCMT-FP Finishing	1121759	SCMT 09T304-FP	⊗	⊗	⊗	⊗																				
	1121765	SCMT 09T308-FP	⊗	⊗	⊗	⊗			⊗																	
 SCMT-FM Finishing	1121758	SCMT 09T304-FM										⊗	⊗					⊗							⊗	
	1121764	SCMT 09T308-FM										⊗	⊗					⊗							⊗	
 SCMT-FK Finishing	1121757	SCMT 09T304-FK																		⊗						
	1121763	SCMT 09T308-FK																			⊗					
 SCMT-MP Medium	1121762	SCMT 09T304-MP	⊗	⊗	⊗	⊗			⊗																	
	1121768	SCMT 09T308-MP	⊗	⊗	⊗	⊗			⊗																	
	1121770	SCMT 120404-MP	⊗	⊗	⊗	⊗																				
	1121783	SCMT 120408-MP	⊗	⊗	⊗	⊗																				
 SCMT-MM Medium	1121785	SCMT 120412-MP	⊗	⊗	⊗	⊗			⊗																	
	1121761	SCMT 09T304-MM									⊗	⊗						⊗							⊗	
	1121767	SCMT 09T308-MM									⊗	⊗						⊗							⊗	
	1121769	SCMT 120404-MM									⊗	⊗						⊗							⊗	
	1121782	SCMT 120408-MM									⊗	⊗						⊗							⊗	
 SCMT-MK Medium	1121784	SCMT 120412-MM									⊗	⊗					⊗								⊗	
	1121760	SCMT 09T304-MK																	⊗	⊗	⊗					
	1121766	SCMT 09T308-MK																	⊗	⊗	⊗					
	1121781	SCMT 120408-MK																	⊗	⊗	⊗					
 SCGT-LN Medium to Finishing	1124008	SCGT 09T304-LN																						⊗		
	1124009	SCGT 09T308-LN																						⊗		
	1124010	SCGT 120404-LN																						⊗		
	1123685	SCGT 120408-LN																						⊗		

⊗ First choice | 1ª Escolha | 1ª Opción

⊗ Stock available until sold out | Stock disponível até acabar o stock | Stock disponible hasta acabar el stock

Insert Order Code: (1) Geometry code + (2) Grade code

⊗ Stock Items | Itens de stock

○ Available under request | Disponível sob consulta | Disponible bajo consulta

RELIEF ANGLE 7°

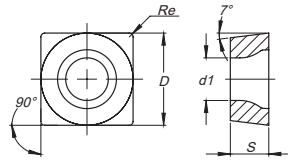

ISO Reference	ANSI Reference	Dimensions (mm) Dimensões (mm) Dimensiones (mm)				Cutting Conditions Condições de Corte Condiciones de Corte					
		D	S	Re	d1	ap (mm)	Min	Max	fn (mm/rev)	Min	Max
SCMW 09T304	SCMW 32.51	9,525	3,97	0,40	4,40	2,40	0,05	4,70	0,20	0,08	0,26
SCMW 09T308	SCMW 32.52	9,525	3,97	0,80	4,40	2,40	0,05	4,70	0,40	0,16	0,53
SCMW 120404	SCMW 431	12,700	4,76	0,40	5,50	3,20	0,05	6,30	0,20	0,08	0,26
SCMW 120408	SCMW 432	12,700	4,76	0,80	5,50	3,20	0,05	6,30	0,40	0,16	0,53
SCMW 120412	SCMW 433	12,700	4,76	1,20	5,50	3,20	0,05	6,30	0,60	0,24	0,80
SCMT 09T304-FP	SCMT 32.51-FP	9,525	3,97	0,40	4,40	0,35	0,11	2,00	0,11	0,06	0,23
SCMT 09T308-FP	SCMT 32.52-FP	9,525	3,97	0,80	4,40	0,35	0,15	2,00	0,15	0,08	0,30
SCMT 09T304-FM	SCMT 32.51-FM	9,525	3,97	0,40	4,40	0,35	0,11	2,00	0,11	0,06	0,23
SCMT 09T308-FM	SCMT 32.52-FM	9,525	3,97	0,80	4,40	0,35	0,15	2,00	0,15	0,08	0,30
SCMT 09T304-FK	SCMT 32.51-FK	9,525	3,97	0,40	4,40	0,35	0,11	2,00	0,11	0,06	0,23
SCMT 09T308-FK	SCMT 32.52-FK	9,525	3,97	0,80	4,40	0,35	0,15	2,00	0,15	0,08	0,30
SCMT 09T304-MP	SCMT 32.51-MP	9,525	3,97	0,40	4,40	0,80	0,25	3,00	0,15	0,08	0,23
SCMT 09T308-MP	SCMT 32.52-MP	9,525	3,97	0,80	4,40	0,80	0,50	3,00	0,25	0,10	0,40
SCMT 120404-MP	SCMT 431-MP	12,700	4,76	0,40	5,50	0,96	0,30	3,60	0,18	0,09	0,27
SCMT 120408-MP	SCMT 432-MP	12,700	4,76	0,80	5,50	0,96	0,60	3,60	0,25	0,12	0,45
SCMT 120412-MP	SCMT 433-MP	12,700	4,76	1,20	5,50	0,96	0,72	3,60	0,35	0,14	0,60
SCMT 09T304-MM	SCMT 32.51-MM	9,525	3,97	0,40	4,40	0,80	0,25	3,00	0,15	0,08	0,23
SCMT 09T308-MM	SCMT 32.52-MM	9,525	3,97	0,80	4,40	0,80	0,50	3,00	0,25	0,10	0,40
SCMT 120404-MM	SCMT 431-MM	12,700	4,76	0,40	5,50	0,96	0,30	3,60	0,18	0,09	0,27
SCMT 120408-MM	SCMT 432-MM	12,700	4,76	0,80	5,50	0,96	0,60	3,60	0,25	0,12	0,45
SCMT 120412-MM	SCMT 433-MM	12,700	4,76	1,20	5,50	0,96	0,72	3,60	0,35	0,14	0,60
SCMT 09T304-MK	SCMT 32.51-MK	9,525	3,97	0,40	4,40	0,80	0,25	3,00	0,15	0,08	0,23
SCMT 09T308-MK	SCMT 32.52-MK	9,525	3,97	0,80	4,40	0,80	0,50	3,00	0,25	0,10	0,40
SCMT 120408-MK	SCMT 432-MK	12,700	4,76	0,80	5,50	0,96	0,60	3,60	0,25	0,12	0,45
SCGT 09T304-LN	SCGT 32.51-LN	9,525	3,97	0,4	4,40	2,05	0,10	4,00	0,16	0,10	0,26
SCGT 09T308-LN	SCGT 32.52-LN	9,525	3,97	0,8	4,40	2,55	0,10	5,00	0,22	0,15	0,40
SCGT 120404-LN	SCGT 431-LN	12,700	4,76	0,4	5,50	2,55	0,10	5,00	0,20	0,10	0,26
SCGT 120408-LN	SCGT 432-LN	12,700	4,76	0,8	5,50	2,55	0,10	5,00	0,30	0,15	0,50

INSERTS RECOMENDATION

EXTERNAL MACHINING | MAQUINAÇÃO EXTERNA | MAQUINACIÓN EXTERNA

General Recommendation:

1. The choice of the insert shape depends of the operation
2. The insert shape should be selected to the required lead angle and the accessibility or versatility required of the tool.
3. Select the largest suitable point angle on the insert for strenght and economy.

Operation	Longitudinal turning	Profiling	Facing	Plunging
Insert Shape				
Rhombic 80°	●●		●	
Rhombic 55°	●	●●	●	
Parallelogram 55°	●	●		●
Round	●	●	●	●●
Square 90°	●		●●	
Triangular 60°	●	●	●	●
Rhombic 35°		●		
Trigon 80°	●		●	







●● Recommended Insert Shape

● Alternative Insert Shape

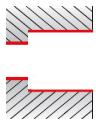
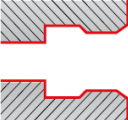
INTERNAL MACHINING | MAQUINAÇÃO INTERNA | MAQUINACIÓN INTERNA

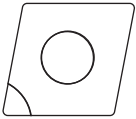
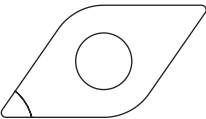
General Recommendation:

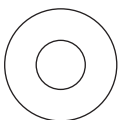
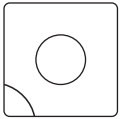
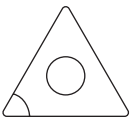
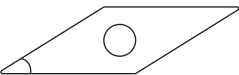
1. The choice of the insert shape depends of the operation
2. The insert shape should be selected to the required lead angle and the accessibility or versatility required of the tool.
3. Select the largest suitable point angle on the insert for strenght and economy.









Insert Shape		Operation		Longitudinal turning	Profiling	Facing
						
	Rhombic 80°		●			●●
	Rhombic 55°		●		●●	●
	Parallelogram 55°		●●			
	Round		●			●
	Square 90°		●			
	Triangular 60°		●●		●	●
	Rhombic 35°				●	
	Trigon 80°		●			●

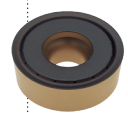

●● Recommended Insert Shape

● Alternative Insert Shape

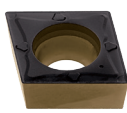
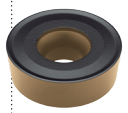

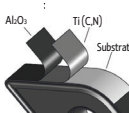
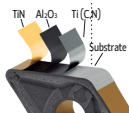
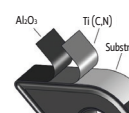
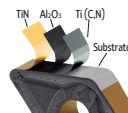
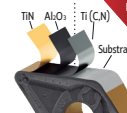
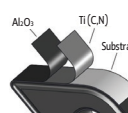
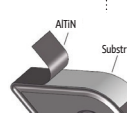
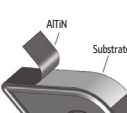



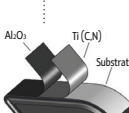
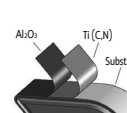
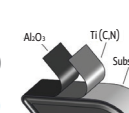
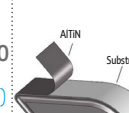

POSITIVE TURNING Application Range Overview

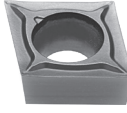
- TURNING
- Insert selection
- Overview
- Negative inserts
- Positive inserts
- PCD inserts
- Heavy machining
- External Toolholders
- Internal Toolholders
- Automatic Lathes
- Spare Parts
- Technical Data

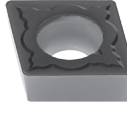
	Fine finishing	Finishing	Medium	Roughing		Heavy roughing	
P 5° & 7°	FS 	FP 	MP 	RF 	RM 		
	BO 	FW 	MW 	ST 	RR 		
	CVD Grades						
		 PH5115 (P10-P25)	 PHG115 (P10-P25)	 PH5125 (P20-P35)	 PHG125 (P20-P35)	 PHG140 (P25-P45)	 PH5740 (P25-P45)
	PVD Grades						
		 PH7910 (P05-P10)	 PH7920 (P10-P35)				
Continuous cut ←			→ Interrupted cut				

	Fine finishing	Finishing	Medium	Roughing	Heavy roughing	
P 11°	12 	13 	FLAT 			
	CVD Grades					
		 PH5115 (P15-P25)	 PH5125 (P20-P35)	 PH5740 (P25-P45)		
	PVD Grades					
		 PH7920 (P10-P35)				
	Continuous cut ←			→ Interrupted cut		

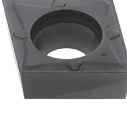
M
5° & 7°

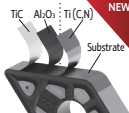
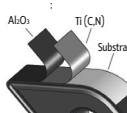
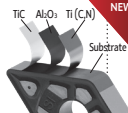
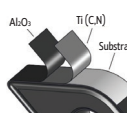
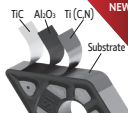
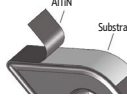
Fine finishing	Finishing		Medium	Roughing		Heavy roughing	
FS 	FM 	LM 	MM 	RF 	RM 		
BO 	FW 	MW 	wiper		RR 		
CVD Grades							
 PHS215 (M10-M25)		 PH5125 (M15-M30)		 PHS225 (M15-M30)		 PH5740 (M25-M45)	
PVD Grades							
 PH7910 (M05-M10)		 PH7920 (M10-M25)					
Continuous cut ←			→ Interrupted cut				





K
5° & 7°

Fine finishing	Finishing		Medium	Roughing	Heavy roughing
FK 		MK 	FLAT 	RM 	
	FW 	wiper	MW 	wiper	ST 
CVD Grades					
 PH5705 (K05-K15)			 PH5320 (K10-K25)		
Uncoated Grades					
 PH0705 (K05-K15)					
Continuous cut ←			→ Interrupted cut		

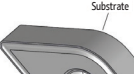
POSITIVE TURNING

Application Range Overview | Vista geral de aplicações | Vista general de aplicaciones

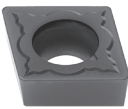

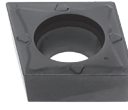
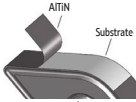
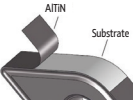

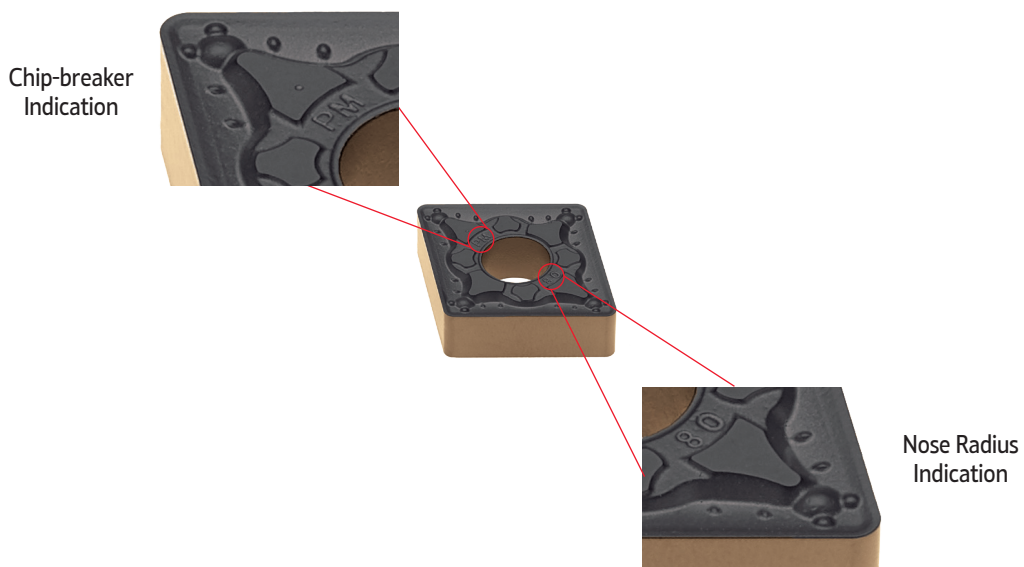

		Fine finishing	Finishing	Medium	Roughing	Heavy roughing
N			LN 			
		Uncoated Grades				
	7°		PH0910 (N01-N20) 			
		Continuous cut ←		→ Interrupted cut		

		Fine finishing	Finishing	Medium	Roughing	Heavy roughing
S		FS 	FM 	LM 	MM 	
		BO 	FW 	MW 	wiper	wiper
	5° & 7°	PVD Grades				
		PH7910 (S05-S10) 		PH7920 (S10-S25) 		
		Continuous cut ←		→ Interrupted cut		

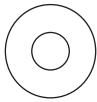
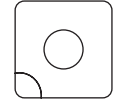
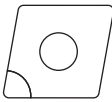

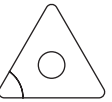
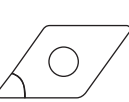
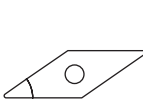
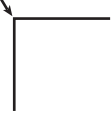
INSERT SHAPE SELECTION

Seleção de geometria para pastilha | Selección de geometria para plaquita

Shape angle		90°	80°	80°	60°	55°	35°	
Geometry shape code	R	S	C	W	T	D	V	
Geometry shape design								
Cutting edge strength								Accessibility 
Vibration tendency								Less power consumption Pc (kW) 

INSERT SHAPE

The insert shape should be selected relative to the entering angle accessibility from tools requirements.

The largest possible nose angle should be selected to provide insert strength and reliability, however, this has to be balanced against the cut variation need to be performed.

A large nose angle is strong, but requires more machine power and has a higher tendency for vibration.

A small nose angle is weaker and has a small cutting edge engagement, both of which can make it more sensitive to the heat effects.

Scale 1: indicates the cutting edge strength. The inserts to the left have larger nose angles and are correspondingly stronger. The right hand inserts have better versatility and accessibility.

Scale 2: indicates that vibration tendencies increase to the left side, while power requirements decrease to the right.

CHIP BREAKER SPECIFICATIONS

POSITIVES | POSITIVAS | POSITIVAS

Insert Type	Application	Tolerance Class	Major field of Application	Geometry	Cutting Edge*		Cutting Conditions**		Available Shapes							
					at the nose radius	at the flank	Feed F _n (mm/rev)	Depth of cut DOC (mm)	CC __	DC __	RC __	SC __	TC __	VC __	VB __	
									80°	55°		90°	60°	35°	35°	
POSITIVES - Clearance angle 5° and 7°	Fine Finishing	M	P	FP			0,03 to 0,45	0,06 to 2,40								
		M	P M S	BO			0,05 to 0,30	0,30 to 1,50								
		M	M S	FM			0,03 to 0,45	0,06 to 2,40								
		M	K	FK			0,03 to 0,30	0,06 to 2,40								
		Fine Finishing wiper	M	P M K S	FW			0,05 to 0,50	0,30 to 3,50							
		Finishing	M	M S NEW	LM			0,08 to 0,35	0,20 to 3,00							
		Finishing to fine finishing	G	P M S	FS			0,01 to 0,25	0,10 to 3,00							
	G		N	LN			0,05 to 1,60	0,05 to 7,00								
		Medium	M	K	Flat			0,04 to 0,80	0,05 to 6,30							
	M		P	MP			0,06 to 0,60	0,19 to 3,60								
	M		M S	MM			0,06 to 0,60	0,19 to 3,60								
	M		K	MK			0,06 to 0,60	0,19 to 3,60								

* T-Land varies according to the IC (IC reference used: 12,7mm)
 ** Cutting Conditions varies according to the Insert shape, IC and Nose Radius

POSITIVES | POSITIVAS | POSITIVAS

Insert Type	Application	Tolerance Class	Major field of Application	Geometry	Cutting Edge*		Cutting Conditions**		Available Shapes							
					at the nose radius	at the flank	Feed F _n (mm/rev)	Depth of cut DOC (mm)	CC __	DC __	RC __	SC __	TC __	VC __	VB __	
									80°	55°		90°	60°	35°	35°	
POSITIVES - Clearance angle 5° and 7°	Finishing Wiper	M	P M K S	MW			0,10 to 0,50	0,50 to 4,00								
	Medium	M	P M S	CP			0,04 to 0,17	0,50 to 2,40								
	Medium to finishing		P M	NEW RF			0,25 to 2,50	2,50 to 10,00								
	Roughing to Medium		M	P M K	ST			0,05 to 3,20	0,80 to 12,80							
					NEW RM			0,80 to 2,50	3,20 to 13,00							
	P M	RR			0,80 to 2,50	3,20 to 13,00										

* T-Land varies according to the IC (IC reference used: 12,7mm)
 ** Cutting Conditions varies according to the Insert shape, IC and Nose Radius

Insert Type	Application	Tolerance Class	Major field of Application	Geometry	Cutting Edge*		Cutting Conditions**		Available Shapes	
					at the nose radius	at the flank	Feed F _n (mm/rev)	Depth of cut DOC (mm)	CC __	DC __
									80°	55°
POSITIVES - Clearance angle 11°	Medium to Finishing	U	P M K S	Flat			0,05 to 2,20	1,00 to 10,00		
	Finishing to Fine Finishing	M	P M K	12			0,03 to 0,55	0,10 to 3,00		
Medium	M	P M	13			0,03 to 0,55	0,20 to 7,00			

* T-Land varies according to the IC (IC reference used: 12,7mm)
 ** Cutting Conditions varies according to the Insert shape, IC and Nose Radius

TURNING GRADES | Graus de torneamento | Calidades para torneado

- TURNING
- Insert selection
- Overview
- Negative inserts
- Positive inserts
- PCD inserts
- Heavy machining
- External Toolholders
- Internal Toolholders
- Automatic Lathes
- Spare Parts
- Technical Data

	ISO	ANSI	Uncoated grades	Coated Grades				
				CVD	PVD			
STEEL	P	05		NEW PHG105		↑ - Wear resistance - Resistência ao desgaste - Resistencia al desgaste		
		10					PH7910	
		15	C7		PHG115		PH5115	PH7920
		20						
		25	C6		PHG125		PH5125	
	30				NEW PHG140	PH5740	↓ - Toughness - Tenacidade - Tenacidad	
	35							
	40							
	45	C5			NEW PHG228			
	50							
STAINLESS STEEL	M	05				↑ - Wear resistance - Resistência ao desgaste - Resistencia al desgaste		
		10	-				PH7910	
		15			NEW PH5115		NEW PH5215	PH7920
		20	-					
		25			PH5125		NEW PH5225	
	30	-			NEW PH5240	PH5740	↓ - Toughness - Tenacidade - Tenacidad	
	35							
	40	-						
	45				NEW PH5228			
	50							
CAST IRON	K	05	C4			↑ - Wear resistance - Resistência ao desgaste - Resistencia al desgaste		
		10	C3		PH5705		PH5320	
		15						
		20	C2					
		25					PH5740	↓ - Toughness - Tenacidade - Tenacidad
30	C1							
35								
40								
ALUMINIUM & NON FERROUS	N	05	C4			↑ - Wear resistance - Resistência ao desgaste - Resistencia al desgaste		
		10	C3					
		15			PH0910			
		20	C2					
		25						↓ - Toughness - Tenacidade - Tenacidad
30	C1							
35								
HEAT RESISTENT / TITANIUM ALLOYS	S	05	-			↑ - Wear resistance - Resistência ao desgaste - Resistencia al desgaste		
		10					PH7910	
		15						PH7920
		20						
		25						
30						↓ - Toughness - Tenacidade - Tenacidad		

Position and grade symbols shape indicate the suitable field of application.

TURNING GRADES DESCRIPTION

Descrição de graus para torneamento | Descripción de calidades para torneado

PVD GRADES

PH7910

P05-P10
M05-M10
S05-S15

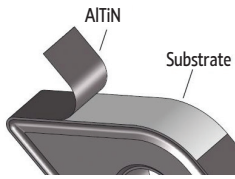

PVD (AlTiN) coated carbide grade with a very hard micro grain substrate improves wear resistance, heat dissipation and avoid built-up edge. High performance on “gummy” materials. For light turning of steels, hardened steels, stainless steels and HRSA.

PH7920

P10-P35
M10-M25
S10-S30

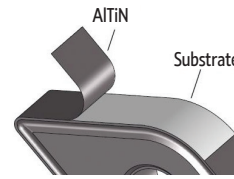

A micro grain size combined with the AlTiN PVD coating make it suitable for Roughing to Finishing operations under good cutting conditions to light interrupted cuts at medium cutting speeds. Suitable for steels, stainless steel, HRSA.

CVD GRADES

PH5115

P10-P25
M10-M25

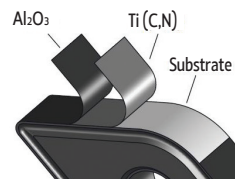

Medium temperature CVD coating with α - Al₂O₃. Carbide grade with a gradient layer close to the surface. Suitable for high to medium cutting speeds on steels & cast steels.

PH5125

P20-P35
M15-M30

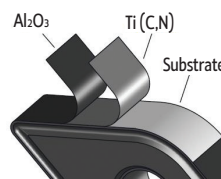

Carbide grade suitable for medium machining of steels & cast steels at medium cutting speeds. The substrate is suitable for the adhesion of the Alumina coating (α - Al₂O₃) medium temperature - CVD, improving the tool life.

PH5740

P25-P45
M25-M45
K20-K40

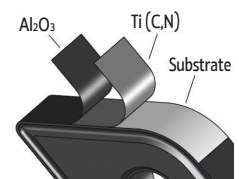

Substrate grade binary (Wc-Co) with medium grain size combined with the medium temperature CVD coating. Suitable for heavy roughing to roughing operations with interrupted cuts at medium to low cutting speeds.

PH5705

K05-K15

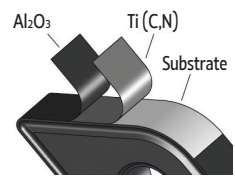

The substrate grade with a very good wear resistance combined with the MT-CVD coating allow to work at high to medium cutting speeds at stable conditions. Recommend for turning of grey cast irons (GCI) or hardened steels. Can also be a solution for high alloy steels.

PH5320

P01-P15
K10-K25

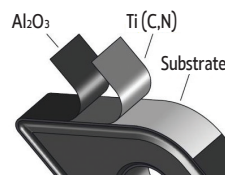

Medium temperature CVD coating (α - Al₂O₃) combined with a hard substrate make it capable of withstanding interrupted conditions. Recommended as general choice for roughing of all cast irons at low to medium cutting speeds. Can also be a solution for high alloy steels.

UNCOATED CARBIDE GRADE

PH0910

N01-N20

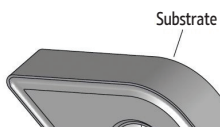

Uncoated carbide micrograin grade combining a good abrasive wear resistance and toughness. Suitable for rough to finish turning of HRSA, Titanium alloys, cast irons and Aluminium alloys.

TURNING GRADES DESCRIPTION

CVD GRADES

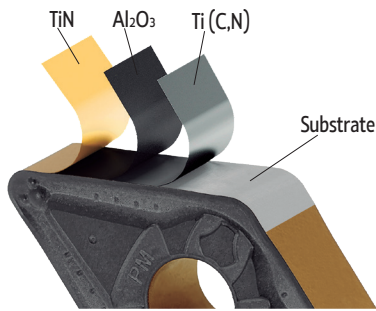

New CVD coating with Al_2O_3+TiN .



PHG105
P05-P10

First choice for continuous cut with hardness higher than 38HRC

New CVD coating with Al_2O_3+TiN combined with a very hard substrate.

PHG115
P10-P25

Suitable for high to medium cutting speeds on steels

New CVD coating with Al_2O_3+TiN .

PHG125
P20-P35

Ideal for general application in all kind of steels

Carbide grade suitable for medium machining of steels at medium cutting speeds.

PHG140
P25-P45

First choice for roughing to heavy roughing operations with interrupted cut at medium to low cutting speeds

Binary substrate grade (Wc - Co) with medium grain size combined with a medium temperature CVD coating.

GRADES CHART | Gráfico de graus | Gráfico de calidades

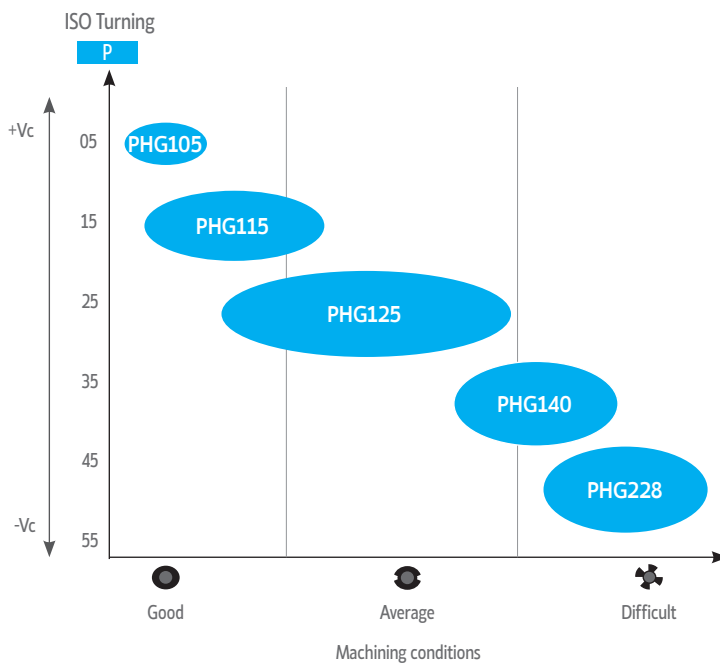

PHG228
P40-P50

A very high toughness grade ideal for heavy roughing applications while using on large I.C inserts

New CVD coating with Al_2O_3+TiN .



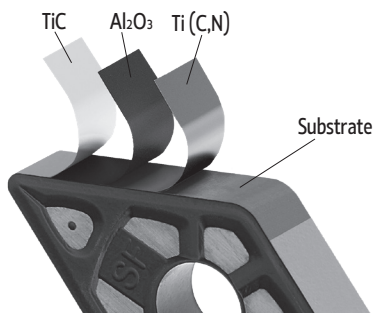

New CVD coating with Al_2O_3+TiC .

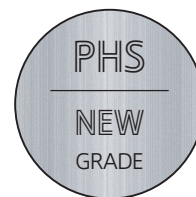

Suitable for high to medium cutting speeds in stainless steel. Ideal for turning on good condition of cut (continuous cut)

New CVD coating with $TiCN+Al_2O_3+TiC$.



First choice for general application on turning of stainless steels

Carbide grade suitable for medium machining of stainless steels and super alloys at medium cutting speeds. New CVD coating with $TiCN+Al_2O_3+TiC$.



First choice for roughing to heavy roughing operations with interrupted cut at medium to low cutting speeds on stainless steel

New CVD coating with $TiCN+Al_2O_3+TiC$.

GRADES CHART || Gráfico de graus | Gráfico de calidades

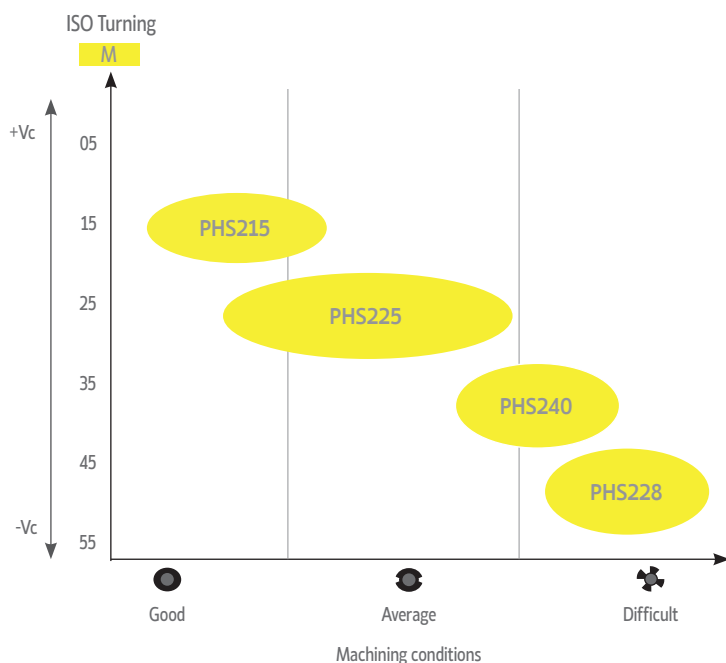

A very high toughness grade ideal for heavy roughing applications while using on large I.C inserts

New CVD coating with $TiCN+Al_2O_3+TiC$.



SELECTION GUIDE (GRADES AND CHIP-BREAKERS) FOR POSITIVE INSERTS

Guia De Seleção (Graus E Quebra-Aparas) para pastilhas positivas | Guía De Selección (Calidades Y Rompevirutas) para plaquitas positivas

SINGLE SIDE...CMT'S, BMT'S, CGT'S, RCMX'S, RCMT'S

ISO	Material Workplace	Stability	Medium		Roughing		Medium roughing		Insert			Holders	
			Chip-breaker	Grade	Chip-breaker	Grade	Chip-breaker	Grade	Type			Type	
High alloyed Steel HB 400 DIN X40CrMoV5 X45GrSi93			FP FK	PH5115 PHG115 PH5705	MP MK	PH5115 PHG115 PH5320 PHG105	MP	PH5115 PHG115		Positive single side	Conventional nose radius	#CMT #BMT	S##C S##B
			FP FK	PH5115 PHG115 PH5320 PHG105	MP MK	PH5115 PHG115 PH5320 PHG105	MP	PH5115 PHG115					
			FP	PH5115 PHG115	MP	PH5125 PHG125	MP	PH5125 PHG125		Positive single side	Wiper nose radius	CCMT	S##C 95°
			FW	PH5115 PHG115	MW	PH5115 PHG115	-	-					
			FW	PH5115 PHG115	MW	PH5115 PHG115	-	-				DCMT TCMT	S##C 93°
		M	Duplex stainless steel DIN X2CrNiMoSi19 X8CrNiMo27 X2CrNiMoN22		FM	PH7910	LM MM	PH7910	MM	PHS215		Positive single side	Conventional nose radius
	FM LM			PH7910	MM	PH7910	MM	PHS215					
	FM LM			PH7920	MM	PH7920	MM	PHS215					
	FW			PH7920	MW	PHS215	-	-		Positive single side	Wiper nose radius	CCMT	S##C 95°
	FW			PH7920	MW	PH5125 PHS225	-	-					
	-			-	-	-	-	-				DCMT TCMT	S##C 93°
Austenitic stainless steel DIN X2CrNiMoSi19 X8CrNiMo27 X2CrNiMoN22			FM LM	PH7910	LM MM	PH7910	MM	PHS215		Positive single side	Conventional nose radius	#CMT #BMT	S##C S##B
			FM LM	PH7920	MM	PH7920	MM	PHS215					
			FM LM	PH5125 PHS225	MM	PHS215	MM	PHS215					
			MW	PH7920	MW	PH7920	-	-		Positive single side	Wiper nose radius	CCMT	S##C 95°
			MW	PHS215	MW	PHS215	-	-					
			MW	PHS215	MW	PHS215	-	-				DCMT TCMT	S##C 93°
Duplex stainless steel DIN X2CrNiMoSi19 X8CrNiMo27 X2CrNiMoN22			FM LM	PH7910	LM MM	PH7910	MM	PHS215		Positive single side	Conventional nose radius	#CMT #BMT	S##C S##B
			FM LM	PH7910	MM	PH7910	MM	PHS215					
			FM LM	PH5125 PHS225	MM	PHS215	MM	PHS215					
			-	-	-	-	-	-		Positive single side	Wiper nose radius	CCMT	S##C 95°
			-	-	-	-	-	-					
			-	-	-	-	-	-				DCMT TCMT	S##C 93°

Stable cutting

General cutting

Unstable cutting

TURNING
Insert selection
Overview
Negative inserts
Positive inserts
PCD inserts
Heavy machining
External Toolholders
Internal Toolholders
Automatic Lathes
Spare Parts
Technical Data

SELECTION GUIDE (GRADES AND CHIP-BREAKERS) FOR POSITIVE INSERTS

Guia De Seleção (Graus E Quebra-Aparas) para pastilhas positivas | Guía De Selección (Calidades Y Rompevirutas) para plaquitas positivas

SINGLE SIDE ...CMT'S, BMT'S, CGT'S, RCMX'S, RCMT'S

ISO	Material Workplace	Stability	Medium		Roughing		Medium roughing		Insert			Holders
			Chip-breaker	Grade	Chip-breaker	Grade	Chip-breaker	Grade	Type		Type	
K	Grey cast iron HB 220 DIN GG15 GG25 GG35	●	FK	PH5705	MK	PH5705	MK	PH5705	Positive single side 	Conventional nose radius 	#CMT #BMT	S##C S##B
			FK	PH5705	MK	PH5705	MK	PH5320				
		✖	MK	PH5320	MK	PH5320	MK	PH5320	Positive single side 	Wiper nose radius 	CCMT	S##C 95°
			FW	PH5705	MW	PH5320	-	-				
		●	FW	PH5705	MW	PH5320	-	-	Positive single side 	Wiper nose radius 	DCMT TCMT	S##C 93°
			MW	PH5320	MW	PH5320	-	-				
	Nodular Cast Iron HB 220 DIN GG15 GG25 GG35	●	FK	PH5705	MK	PH5320	MK	PH5320	Positive single side 	Conventional nose radius 	#CMT #BMT	S##C S##B
			FK	PH5705	MK	PH5320	MK	PH5320				
		✖	MK	PH5320	MK	PH5320	MK	PH5320	Positive single side 	Wiper nose radius 	CCMT	S##C 95°
			FW	PH5705	MW	PH5320	-	-				
		●	FW	PH5705	MW	PH5320	-	-	Positive single side 	Wiper nose radius 	DCMT TCMT	S##C 93°
			MW	PH5320	MW	PH5320	-	-				
S	Titanium Alloys DIN TiAl5Sn2.5 TiAl6V4 TiAl6V4ELI	●	FS	PH7910	FM	PH7910	MM	PH7920	Positive single side 	Conventional nose radius 	#CMT #BMT	S##C S##B
			FM	PH7920	MM	PH7920	MM	PH7920				
		✖	MM	PH7920	MM	PH7920	MM	PH7920	Positive single side 	Wiper nose radius 	CCMT	S##C 95°
			FW	PH7920	FW	PH7920	-	-				
		●	FW	PH7920	MW	PH7920	-	-	Positive single side 	Wiper nose radius 	DCMT TCMT	S##C 93°
			MW	PH7920	MW	PH7920	-	-				
	Super alloys DIN NiCr19Co11MoTi NiFe35Cr14MoTi CoCr20W15Ni	●	FS	PH7910	FM	PH7910	MM	PH7920	Positive single side 	Conventional nose radius 	#CMT #BMT	S##C S##B
			FM	PH7920	FM	PH7920	FM	PH7920				
		✖	MM	PH7920	MM	PH7920	MM	PH7920	Positive single side 	Wiper nose radius 	CCMT	S##C 95°
			FW	PH7920	FW	PH7920	-	-				
		●	FW	PH7920	MW	PH7920	-	-	Positive single side 	Wiper nose radius 	DCMT TCMT	S##C 93°
			MW	PH7920	MW	PH7920	-	-				
N	Aluminium Alloys DIN AW7075 AISI12 CuZn37	●	LN	PH0910	LN	PH0910	-	-	Positive single side 	Conventional nose radius 	#CMT #BMT	S##C S##B
		●	LN	PH0910	LN	PH0910	-	-				
		✖	LN	PH0910	LN	PH0910	-	-				

● Stable cutting

● General cutting

✖ Unstable cutting

ISO	Material	Grade fn (mm/r) HB (brinell)	CVD Coating															
			← Wear Resistance												Toughness →			
			PHG105			PH5115			PHG115			PH5125			PHG125			
			0.2	0.4	0.8	0.2	0.4	0.8	0.2	0.4	0.8	0.2	0.4	0.8	0.2	0.4	0.8	
P	Unalloyed steel	125-170	280-380	210-300	200-250	250-350	180-270	170-220	250-350	180-270	170-220	200-295	170-240	150-215	200-295	170-240	150-215	
	Low-alloy steel	180-350	220-280	200-260	170-210	190-250	170-230	140-180	190-250	170-230	140-180	170-230	140-210	120-190	170-230	140-210	120-190	
	High-alloy stel	200-325	165-250	150-235	140-230	135-220	120-205	110-200	135-220	120-205	110-200	125-215	110-185	100-170	125-215	110-185	100-170	
P	Material	Grade fn (mm/r) HB (brinell)	CVD Coating						PVD Coating									
			← Wear Resistance						Toughness →			← Wear Resistance			Toughness →			
			PHG140			PH5740			PH7910			PH7920						
			0.2	0.4	0.8	0.2	0.4	0.8	0.2	0.4	0.8	0.2	0.4	0.8	0.2	0.4	0.8	
P	Unalloyed steel	125-170	135-230	120-210	115-200	135-230	120-210	115-200	140-245	130-225	115-220	130-230	120-220	110-210				
	Low-alloy steel	180-350	125-205	105-185	95-185	125-205	105-185	95-185	130-230	125-225	125-215	125-220	115-210	100-200				
	High-alloy stel	200-325	105-205	75-175	50-135	105-205	75-175	50-135	-	-	-	-	-	-				

ISO	Material	Grade fn (mm/r) HB (brinell)	CVD Coating											
			← Wear Resistance									Toughness →		
			PH5215			PH5125			PH5225			PH5740		
			0.2	0.4	0.6	0.2	0.4	0.6	0.2	0.4	0.6	0.2	0.4	0.6
M	SS - Ferritic/martensitic	200-330	125-260	100-220	80-200	110-230	70-175	50-135	110-230	70-175	50-135	85-180	65-160	45-135
	SS - Austenitic	180-330	130-290	100-240	80-190	100-240	70-175	55-130	100-240	70-175	55-130	85-170	65-145	45-125
	SS - Austenitic-ferritic (Duplex)	230-260	190-220	150-185	120-145	150-190	120-150	90-110	150-190	120-150	90-110	130-160	110-135	85-105
M	Material	Grade fn (mm/r) HB (brinell)	PVD Coating											
			← Wear Resistance						Toughness →					
			PH7910			PH7920								
			0.2	0.4	0.6	0.2	0.4	0.6						
M	SS - Ferritic/martensitic	200-330	128-230	120-220	115-215	133-235	130-225	120-220						
	SS - Austenitic	180-330	124-225	115-215	105-205	129-223	125-220	115-215						
	SS - Austenitic-ferritic (Duplex)	230-260	121-212	110-205	100-195	125-216	115-210	100-200						

ISO	Material	Grade fn (mm/r) HB (brinell)	CVD Coating								
			← Wear Resistance						Toughness →		
			PH5705			PH5320			PH5740		
			0.2	0.4	0.6	0.2	0.4	0.6	0.2	0.4	0.6
K	Marble cast iron	130-230	160-360	140-280	120-235	150-330	130-240	110-220	110-230	100-215	100-190
	Grey cast iron	180-220	220-380	190-330	150-290	200-330	170-280	150-230	150-230	140-220	110-210
	Nodular cast iron	160-380	150-280	135-265	120-220	140-250	125-230	110-220	125-220	115-205	105-185

ISO	Material	Grade fn (mm/r) HB (brinell)	Uncoated	
			PH0910	
			0.15	0.8
N	Aluminium alloys	60-130	375-2400	40-240
	Cooper and cooper alloys	90-110	375-630	35-65

ISO	Material	Grade fn (mm/r) HB (brinell)	PVD Coating					
			← Wear Resistance			Toughness →		
			PH7910			PH7920		
			0.1	0.3	0.5	0.1	0.3	0.5
S	Heat resistant super alloys (Iron base)	200-280	75-130	62-127	55-115	70-120	55-115	50-110
	Heat resistant super alloys (Nickel base)	250-320	55-95	40-90	33-85	35-80	27-75	23-70
	Heat resistant super alloys (Cobalt base)	200-320	55-95	40-90	33-85	35-80	27-75	23-70
	Titanium alloys (400-or<1050[MPa])	-	80-172	70-162	65-155	65-152	50-145	45-135

ISO TURNING INSERTS CODE KEY

H		M	
O		V	
P		W	
S		L	
T		A	
C		B	
D		K	
E		R	
F		X	Special

1 - Insert shape symbol

Symbol	m (mm)	d (mm)	s (mm)
A	±0.005	±0.025	±0.025
F	±0.005	±0.013	±0.025
C	±0.013	±0.025	±0.025
H	±0.013	±0.013	±0.025
E	±0.025	±0.025	±0.025
G	±0.025	±0.025	±0.13
J	±0.005	±0.05~±0.13	±0.025
K*	±0.013	±0.05~±0.13	±0.025
L*	±0.025	±0.05~±0.13	±0.025
M*	±0.08~±0.20	±0.05~±0.13	±0.13
N*	±0.08~±0.20	±0.05~±0.13	±0.025
U*	±0.13~±0.38	±0.08~±0.25	±0.13

Triangular inserts with a facet (secondary cutting edge)

Detailed dimension of M class insert Insert height Tolerances (mm)					
Inscribed circle	T	S	C	D	V
6.35	±0.08	-	-	-	-
9.525	±0.08	±0.08	±0.11	±0.10	±0.13
12.70	±0.13	±0.13	±0.13	±0.15	-
15.875	±0.15	±0.15	±0.15	±0.18	-
19.05	±0.15	±0.15	±0.15	±0.18	-
25.40	-	±0.18	-	-	-
31.75	-	±0.25	-	-	-

Inscribed circle Tolerances (mm)					
Inscribed circle	T	S	C	D	V
6.35	±0.05	-	-	-	-
9.525	±0.05	±0.05	±0.05	±0.05	±0.05
12.70	±0.08	±0.08	±0.08	±0.08	±0.08
15.875	±0.10	±0.10	±0.10	±0.10	±0.10
19.05	-	-	-	-	±0.10
25.40	-	±0.13	-	-	±0.10
31.75	-	±0.20	-	-	±0.12

3 - Tolerances symbol

*As a rule, the sides of these inserts are as sintered. Tolerance differs with insert size, for the accuracy of class M, refer to the table on the right.

A	B	C	D	E
				Other clearance angle

2 - Normal clearance symbol



4 - Insert symbol															
symbol	Type	Hole type	Chipbreaker	Shape	symbol	Type	Hole type	Chipbreaker	Shape	symbol	Type	Hole type	Chipbreaker	Shape	
W	with hole	Round hole / one countersink (40°-60°)	Without chipbreaker		H	with hole	Round hole / one countersink (70°-90°)	Chipbreaker on one side		G	with hole	Round hole	Chipbreaker on both sides		
T			Chipbreaker on one side		C		Round hole / double countersink (70°-90°)	Without chipbreaker		N		-	Without chipbreaker		
Q		Round hole / double countersink (40°-60°)	Without chipbreaker		J		Round hole	Round hole	Chipbreaker on both sides		R	without hole	-	Chipbreaker on one side	
U			Chipbreaker on both sides		A				Without chipbreaker		F		-	Chipbreaker on both sides	
B		Round hole / one countersink (70°-90°)	Without chipbreaker		M		Chipbreaker on one side		X	-	-	-	-	-	On request

R's	35° V's	55° D's	80° C's	90° S's	60° T's	80° W's	Ø CI		ANSI
							mm	inch	Symbol
-	06	04	-	03	06	02	3,97	5/32	1,20
-	08	05	04	04	08	L3	4,76	3/16	1,50
-	09	06	05	05	09	03	5,56	7/32	1,80
06**	-	-	-	-	-	-	6,00	0,236	
06*	11	07	06	06	11	04	6,35	1/4	2,00
07*	13	09	08	07	13	05	7,94	5/16	2,50
08*	-	-	-	-	-	-	8,00	0,315	
09*	16	11	09	09	16	06	9,525	3/8	3,00
10**	-	-	-	-	-	-	10,00	0,394	
12**	-	-	-	-	-	-	12,00	0,472	
12*	22	15	12	12	22	08	12,70	1/2	4,00
15*	27	19	16	15	27	10	15,875	5/8	5,00
16**	-	-	-	-	-	-	16,00	0,63	
19*	33	23	19	19	33	13	19,05	3/4	6,00
20**	-	-	-	-	-	-	20,00	0,787	
25**	-	-	-	-	-	-	25,00	0,984	
25*	44	31	25	25	44	17	25,40	1,00	8,00
31*	54	38	32	31	54	21	31,75	1 1/4	10,00
32**	-	-	-	-	-	-	32,00	1,26	

5 - Insert size symbol

* ANSI designation only
(Radius Designation is R0)

** Metric designation only
(Radius Designation is M0)

According to International Standard ISO 1832 - 2012(E)

"Indexable inserts for cutting tools - Designation"

ISO	mm	ANSI	inch
01	1.59	1	0.062
T1	1.98	1.2	0.078
02	2.38	1.5	0.094
03	3.18	2	0.125
T3	3.97	2.5	0.156
04	4.76	3	0.188
05	5.56	3.5	0.219
06	6.35	4	0.250
07	7.94	5	0.312
09	9.52	6	0.375
12	12.70	8	0.500

6 - Insert thickness symbol



ISO	mm	inch	ANSI
00	Sharp nose		0
01	0.10	.004	0.2
02	0.20	.008	0.5
04	0.40	.015	1
08	0.80	.032	2
12	1.2	.047	3
16	1.6	.062	4
20	2.0	.078	5
24	2.4	.094	6
28	2.8	.109	7
32	3.2	.125	8
00 (inch or M0/metric)	Round insert		0

7.1* - Insert edges symbol			
For inserts having secondary edges two digits are used:			
1 st digit is secondary edge		2 nd digit is secondary edges relief angle	
A	45°	A	3°
D	60°	B	5°
E	75°	C	7°
F	85°	D	15°
P	90°	E	20°
Z	special	F	25°
*only when required.		G	30°
		N	0°
		P	11°
		Z	special

POSITIVE Chipbreakers	FLAT	FP	BO	FM	FK	FW	LM	MP	MM

10 - Chipbreaker geometries				
FLAT	MF	SF	LC	MS
MR	PM	ST	MW	SS
HR	RP	HY	HZ	

NEGATIVE Chipbreakers

8* - Cutting edge information		
Shape	Honing	Symbol
	No honing	F
	With honing	E
	Chamfered No honing	T
	Chamfered with honing	S
*only when required.		

9* - Cutting direction		
Shape	Hand	Symbol
	Right	R
	Left	L
	None	N
*only when required.		