



auf Druck und Zug

Quick change tapping chucks with length compensation on compression and expansion

Mandrins de taraudage à changement rapide avec compensation longitudinale à la compression et traction



Verwendung:

Zur Aufnahme von Schnellwechsel-Einsätzen für Gewindebohrer.

Application:

For the chucking of quick change adaptors for taps.

Application:

Pour le serrage d'adaptateurs portetafonds à changement rapide.

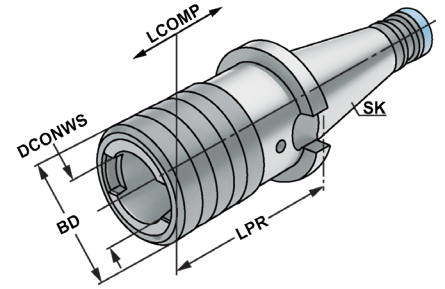

4



Bestell-Nr. Order no. Référence	SK	Spannbereich Capacity Capacité	Größe Size Taille	LPR	BD	DCONWS	LCOMP
301.16.12	SK 30	M3 - M14	1	55	38	19	7
301.16.20	SK 30	M5 - M22	2	86	54	31	12
401.16.12	SK 40	M3 - M14	1	55	38	19	7
401.16.20	SK 40	M5 - M22	2	86	54	31	12
401.16.36	SK 40	M14 - M36	3	132	78	48	17,5
501.16.12	SK 50	M3 - M14	1	62	38	19	7
501.16.20	SK 50	M5 - M22	2	90	54	31	12
501.16.36	SK 50	M14 - M36	3	117	78	48	17,5

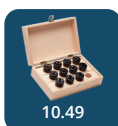

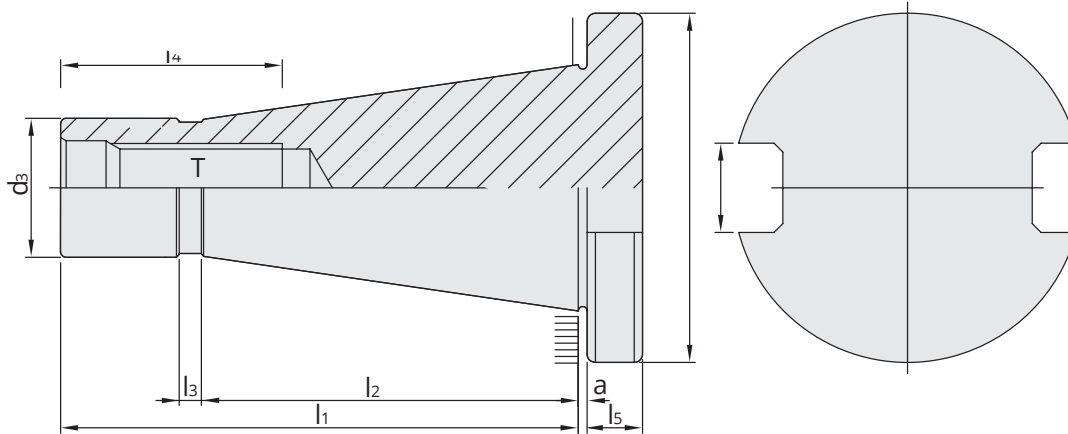
4

SK	D	d ₁	d ₂	d ₃	a	l ₁	l ₂	l ₃	l ₄	l ₅	T
	⁰ _{-0,4}		H12	min	±0.2					±0.15	
30	50	31,75	16,1	17,04	1,6	68,4	48,4	3	24	8	M12
40 ★	63	44,45	16,1	24,92	1,6	93,4	65,4	5	32	10	M16
50 ★	97,5	69,85	25,7	39,19	3,2	126,8	101,8	8	47	12	M24

- ★ Mit Kunststoff-Kantenschutzring
- ★ With plastic protection ring
- ★ Avec bague de protection en plastique

Vorgewuchtet G 6,3 15.000 min⁻¹
Pre-balanced
Pré-équilibré

G 2,5 Feinwuchten gegen Aufpreis
G 2.5 Fine balancing at extra charge
G 2,5 Equilibrage fin contre un supplément

Werkstoff: Legierter Einsatzstahl mit einer Zugfestigkeit im Kern von min. 950 N / mm². Einsatzgehärtet HRC 60 ± 2 (HV 700 ± 50), Härtetiefe 0,8 mm ± 0,2 mm, brüniert und präzisionsgeschliffen.

Genauigkeit: Kegelwinkel – Toleranzqualität < AT 3 nach DIN 7187 und DIN 2080.

Material: *Alloyed case-hardened steel, tensile core strength of min. 950 N / mm². Case hardened HRC 60 ± 2 (HV 700 ± 50), hardening depth 0.8 mm ± 0.2 mm, black-finished and precisely grinded.*

Accuracy: *Quality of taper < AT 3 according to DIN 7187 and DIN 2080.*

Matière: Acier de cémentation allié. Résistance à la traction dans le noyau de min 950 N / mm². Cémentation à HRC 60 ± 2 (HV 700 ± 50), profondeur de cémentation 0,8 mm ± 0,2 mm, bruni et rectifié précisément.

Précision: Qualité du cône < AT 3 selon DIN 7187 et DIN 2080.

Normative Verweise:
Normative references:
Références normatives:

DIN 2080-1:2011-11
Steilkegelschäfte für Werkzeuge und Spannzeuge

DIN 2080-1:2011-11
7/24 taper shanks for tools and clamping devices

DIN 2080-1:2011-11
Queues coniques 7/24 pour outils et dispositifs de serrage



Example:

40 3 . 02 . 20 . 1





The process of tapping is a complex balance of rotational and axial movements of the tool. It is sometimes necessary to restrict the axial movements of the tool.

If the axial movement is not accurately controlled, the leading or trailing flanks of the tap may be forced to progressively “shave” one flank of the component thread, thus producing a thin and oversize thread in the component.

Tension – forward float capability allows the tap to progress into the component without interference from the axial feed of the machine spindle.

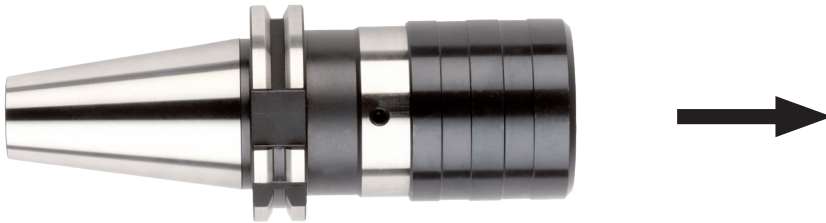

Compression – backward float capability, acts as a cushion and allows the tap to commence cutting at its own axial feed independent of the machine spindle.

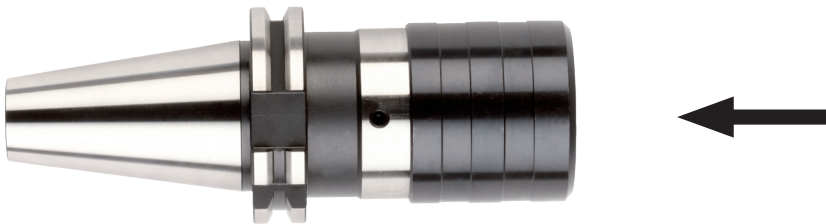

Compression/Tension – float is designed to negate any external forces during the machining operation.

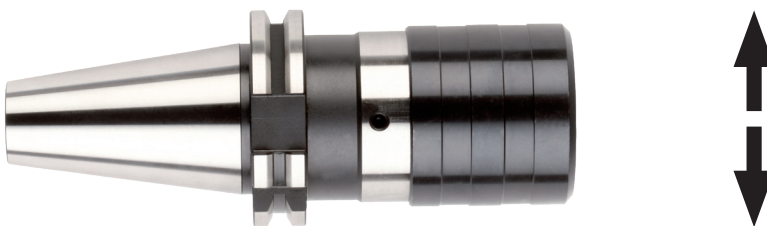

Radial float – allows for slight misalignment of the machine spindle axis and hole axis prior to tapping. This is not recommended manufacturing practice and should be avoided.

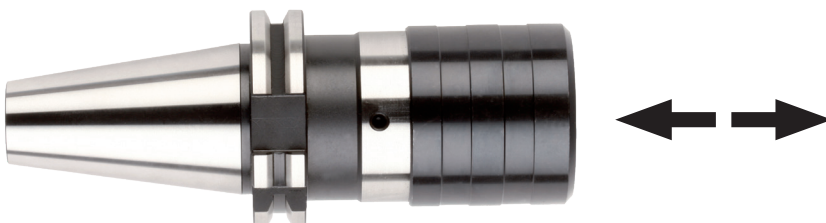



For a correct use of the tapping chuck, please check, during the first thread, not to exceed the max. axial stroke of the compensation values. This is to avoid damaging the thread or the tapping chuck.



Adjustment screw for amplification of chamfer edge pressure. Turning the screw clockwise amplifies the chamfer edge pressure.

Compensation in compression



Compensation in extension

Code	Tap capacity	Adapters	Length adjustment in mm on	
			Compression	Extension
xxx.16.12	M 3 - M14	16.11.xx / 16.01.xx	7	7
xxx.16.20	M 5 - M22	16.12.xx / 16.02.xx	12	12
xxx.16.36	M14 - M36	16.14.xx / 16.03.xx	17.5	17.5