



End mill holders DIN 6359 with coolant channels for end mills DIN 1835-B

Porte-fraises DIN 6359 avec canaux d'arrosage pour queues cylindriques DIN 1835-B



Verwendung:

Zum Spannen von zylindrischen Werkzeugschäften mit seitlicher Spannfläche nach DIN 1835 Form B (Weldon). Mit Kühlkanälen für optimale Kühlung der Werkzeugschneide.

Application:

For mounting straight-shank tools with lateral flat according to DIN 1835 form B (Weldon). With coolant channels for optimal coolant at the cutting edge.

Application:

Pour le serrage d'outils avec queue cylindrique et avec méplat de serrage latéral suivant DIN 1835 forme B (Weldon). Avec canaux d'arrosage pour refroidissement optimal des coupes.

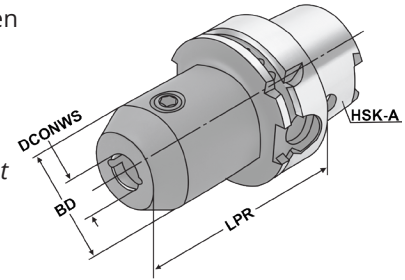

Bestell-Nr. Order no. Référence	HSK	DCONWS	TDCON	LPR	BD
A63.04.06.K	HSK-A 63	6	H4	65	25
A63.04.08.K	HSK-A 63	8	H4	65	28
A63.04.10.K	HSK-A 63	10	H4	65	35
A63.04.12.K	HSK-A 63	12	H4	80	42
A63.04.14.K	HSK-A 63	14	H4	80	44
A63.04.16.K	HSK-A 63	16	H4	80	48
A63.04.18.K	HSK-A 63	18	H4	80	50
A63.04.20.K	HSK-A 63	20	H4	80	52
A63.04.25.K	HSK-A 63	25	H4	110	65
A63.04.32.K	HSK-A 63	32	H4	110	72
A63.04.40.K	HSK-A 63	40	H4	125	80
A63.04.06.1.K	HSK-A 63	6	H4	100	25
A63.04.08.1.K	HSK-A 63	8	H4	100	28
A63.04.10.1.K	HSK-A 63	10	H4	100	35
A63.04.12.1.K	HSK-A 63	12	H4	100	42
A63.04.14.1.K	HSK-A 63	14	H4	100	44
A63.04.16.1.K	HSK-A 63	16	H4	100	48
A63.04.18.1.K	HSK-A 63	18	H4	100	50
A63.04.20.1.K	HSK-A 63	20	H4	100	52
A63.04.06.130.K	HSK-A 63	6	H4	130	25
A63.04.08.130.K	HSK-A 63	8	H4	130	28
A63.04.10.130.K	HSK-A 63	10	H4	130	35
A63.04.12.130.K	HSK-A 63	12	H4	130	35
A63.04.14.130.K	HSK-A 63	14	H4	130	44
A63.04.16.130.K	HSK-A 63	16	H4	130	48
A63.04.18.130.K	HSK-A 63	18	H4	130	50
A63.04.20.130.K	HSK-A 63	20	H4	130	52
A100.04.06.K	HSK-A 100	6	H4	80	25
A100.04.08.K	HSK-A 100	8	H4	80	28
A100.04.10.K	HSK-A 100	10	H4	80	35
A100.04.12.K	HSK-A 100	12	H4	80	42
A100.04.14.K	HSK-A 100	14	H4	80	44
A100.04.16.K	HSK-A 100	16	H4	100	48
A100.04.18.K	HSK-A 100	18	H4	100	50
A100.04.20.K	HSK-A 100	20	H4	100	52
A100.04.25.K	HSK-A 100	25	H4	100	65
A100.04.32.K	HSK-A 100	32	H4	100	72
A100.04.40.K	HSK-A 100	40	H4	105	80

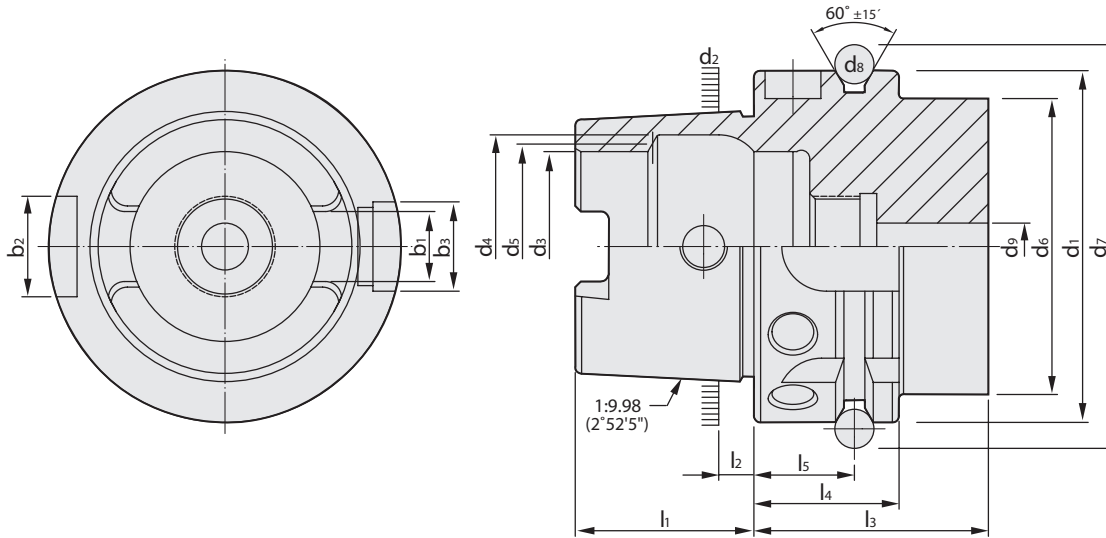

5

HSK	d ₁	d ₂	d ₃	d ₄	d ₅	d ₆	d ₇	d ₈	d ₉	l ₁	l ₂	l ₃	l ₄	l ₅	b ₁	b ₂	b ₃
	h10		H10	H11		max	⁰ _{-0,1}		max	⁰ _{-0,2}		min	⁰ _{-0,1}	±0,1	±0,04	H10	H10
25	25	19,006	14	16,4	15	20	28,5	3	3	13	2,5	20	10	4,5	6,05	6	7
32	32	24,007	17	20,5	19	26	37	4	4,2	16	3,2	35	20	16	7,05	7	9
40	40	30,007	21	25,5	23	34	45	4	5	20	4	35	20	16	8,05	9	11
50	50	38,009	26	32	29	42	59,3	7	6,8	25	5	42	26	18	10,54	12	14
63	63	48,010	34	40	37	53	72,3	7	8,4	32	6,3	42	26	18	12,54	16	18
80	80	60,012	42	50	46	68	88,8	7	10,2	40	8	42	26	18	16,04	18	20
100	100	75,013	53	63	58	88	109,75	7	12	50	10	45	29	20	20,02	20	22
125	125	95,016	67	80	73	111	134,75	7	14	63	12,5	45	29	20	25,02	25	28

Vorgewuchtet G 6,3 15.000 min-1
 Pre-balanced G 6,3 15.000 min-1
 Pré-équilibré G 6,3 15.000 min-1

G 2,5 Feinwuchten gegen Aufpreis
 G 2.5 Fine balancing at extra charge
 G 2,5 Equilibrage fin contre un supplément

Werkstoff: Legierter Einsatzstahl mit einer Zugfestigkeit im Kern von min. 950 N / mm². Einsatzgehärtet HRC 60 ± 2 (HV 700 ± 50), Härtetiefe 0,8 mm ± 0,2 mm, brüniert und präzisionsgeschliffen.

Material: Alloyed case-hardened steel, tensile core strength of min. 950 N / mm². Case hardened HRC 60 ± 2 (HV 700 ± 50), hardening depth 0.8 mm ± 0.2 mm, black-finished and precisely grinded.

Matière: Acier de cémentation allié. Résistance à la traction dans le noyau de min 950 N / mm². Cémentation à HRC 60 ± 2 (HV 700 ± 50), profondeur de cémentation 0,8 mm ± 0,2 mm, bruni et rectifié précisément.

Normative Verweise:

ISO 12164-1:2001-12
 Hohlkegelschnittstelle mit Plananlage
 - Teil 1: Schäfte; Maße

Normative references:

ISO 12164-1:2001
 Hollow taper interface with flange contact surface
 - Part 1: Shanks; Dimensions

Références normatives:

ISO 12164-1:2001
 Interfaces à cône creux-face
 - Partie 1: Queues; Dimensions

DIN 69893-1:2011
 Kegel-Hohlschäfte mit Plananlage besteht aus:
 - Teil 1: Kegel-Hohlschäfte Form A und Form C;
 Maße und Ausführung

DIN 69893-1:2011
 Hollow taper shanks with flange contact surface:
 - Part 1: Hollow taper shanks type A and type C;
 Dimensions and design

DIN 69893-1:2011
 Queues creuses coniques à surface de contact plane:
 - Partie 1: Queues creuses coniques type A et type C;
 Dimensions et conception



Example:

40 3 . 02 . 20 . 1

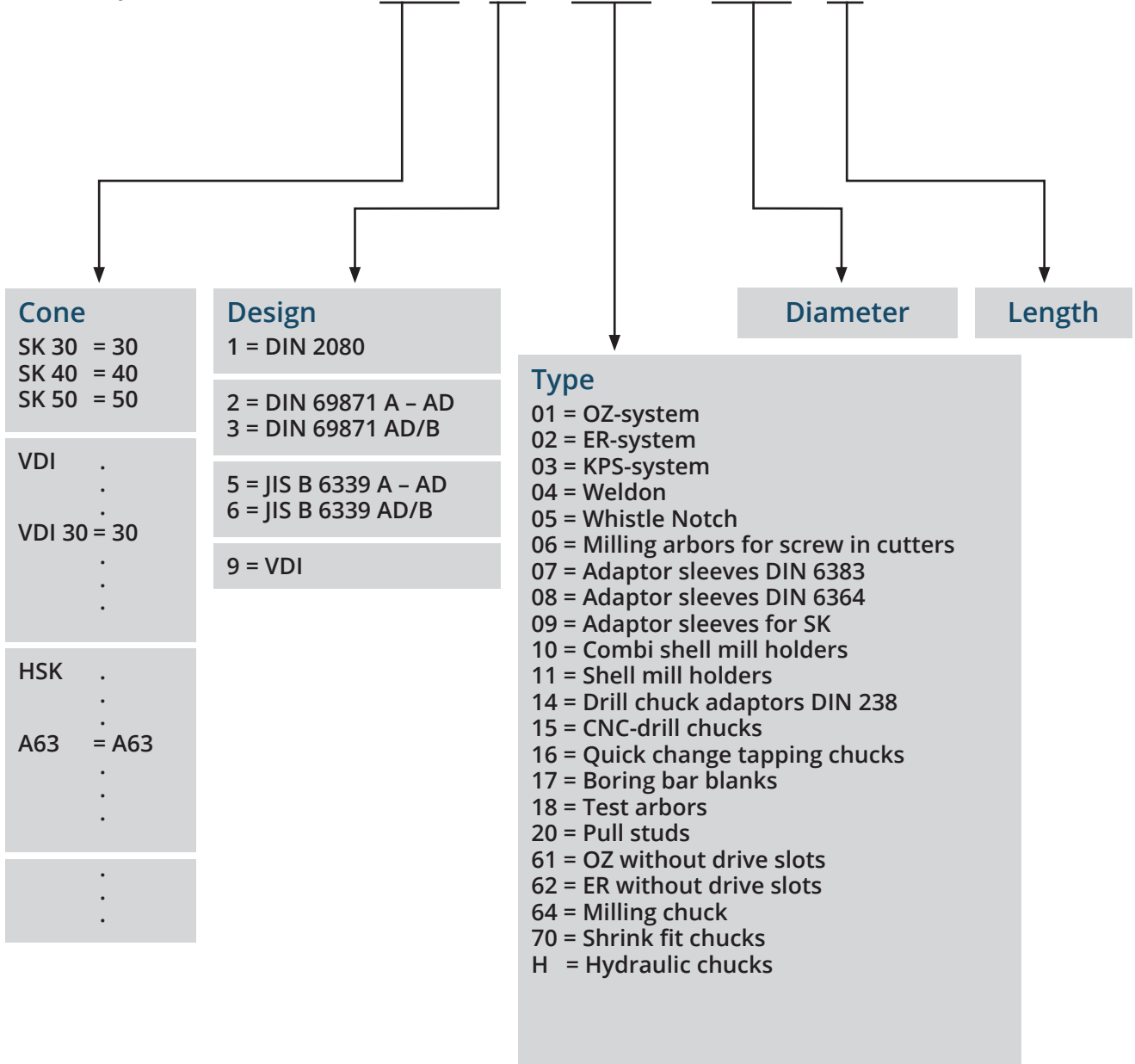



Highest concentricity by using defined torques with Weldon shafts:



Torques for DIN 1835

Bore	Screw		Torque
Ø 6 mm	M 6	SW 3	10 Nm
Ø 8 mm	M 8	SW 4	10 Nm
Ø 10 mm	M 10	SW 5	16 Nm
Ø 12 mm	M 12	SW 6	28 Nm
Ø 14 mm	M 12	SW 6	28 Nm
Ø 16 mm	M 14	SW 6	42 Nm
Ø 18 mm	M 14	SW 6	42 Nm
Ø 20 mm	M 16	SW 8	50 Nm
Ø 25 mm	M 18 × 2	SW 10	60 Nm
Ø 32 mm	M 20 × 2	SW 10	72 Nm
Ø 40 mm	M 20 × 2	SW 10	72 Nm
Ø 50 mm	M 24 × 2	SW 12	90 Nm
Ø 63 mm	M 24 × 2	SW 12	90 Nm

The load limits of the spindle mount must be complied with.

Operating temperature: + 20 °C ... + 50 °C

Max. coolant pressure: 80 bar

Clamp-Ø	max. Speed in m ⁻¹		Max. Tightening torque of the clamping screw	Clamping screw	SW	Shank-Ø in mm
	LPR to 125mm	LPR about 125mm				
Ø 6 mm	50.000	30.000	10 Nm	M 6	SW 3	Ø 6 h6
Ø 8 mm	50.000	30.000	10 Nm	M 8	SW 4	Ø 8 h6
Ø 10 mm	50.000	30.000	16 Nm	M 10	SW 5	Ø 10 h6
Ø 12 mm	50.000	30.000	28 Nm	M 12	SW 6	Ø 12 h6
Ø 14 mm	50.000	30.000	28 Nm	M 12	SW 6	Ø 14 h6
Ø 16 mm	50.000	30.000	42 Nm	M 14	SW 6	Ø 16 h6
Ø 18 mm	50.000	30.000	42 Nm	M 14	SW 6	Ø 18 h6
Ø 20 mm	50.000	30.000	50 Nm	M 16	SW 8	Ø 20 h6
Ø 25 mm	25.000	20.000	60 Nm	M 18 × 2	SW 10	Ø 25 h6
Ø 32 mm	25.000	20.000	72 Nm	M 20 × 2	SW 10	Ø 32 h6



DIN 69063-1 (ISO 12164-1) Form A

Standard type for machining centres and milling machines. HSK for automatic tool change with gripper groove and index notch. Manual operation is via access hole in taper. Form B relies on driving dogs on the joint face as shank isn't slotted. Torque is transmitted through highly accurate connection.

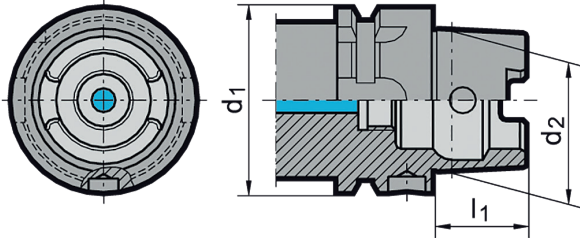

DIN 69063-2 (ISO 12164-1) Form B

For machining centres, milling and turning machines. With enlarged flange size for rigid machining. For automatic tool change. Coolant supply through the flange. Drive keys at the flange. Hole for data carrier DIN STD 69873 at the flange.

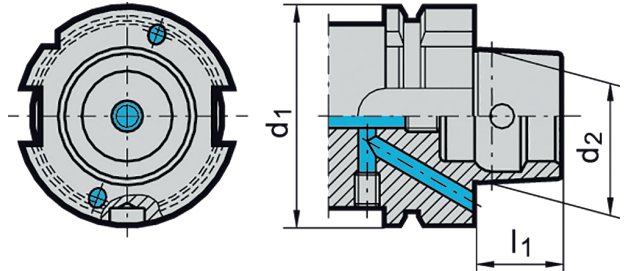

DIN 69063-1 (ISO 12164-1) Form C

For transfer lines, special machines and modular tooling systems. HSK for manual tool change. Operation is via access hole in taper. Form D relies on driving dogs on the joint face as shank isn't slotted. Torque is transmitted through highly accurate connection.

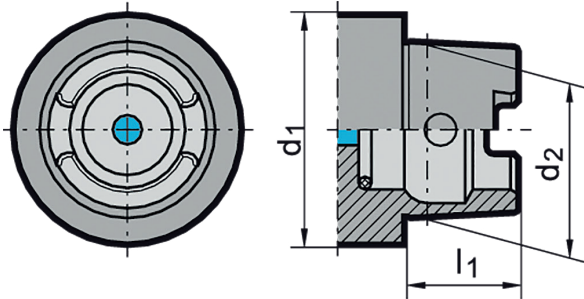

DIN 69063-2 (ISO 12164-2) Form D

For special machines. With enlarged flange size for rigid machining. For manual tool change. Coolant supply through the flange. Drive keys at the flange.

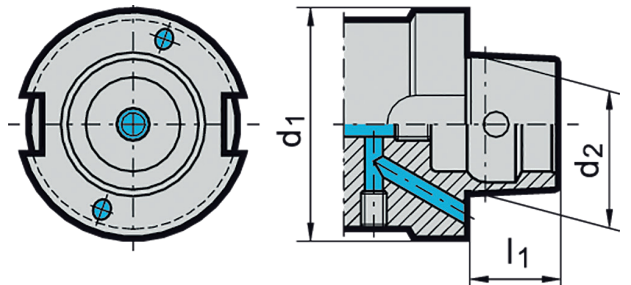

DIN 69063-5 Form E

For high-speed applications. For automatic tool change. HSK for automatic tool change. Torque is transmitted through highly accurate connection. Version with access hole acc. to DIN 69893-1 by arrangement.

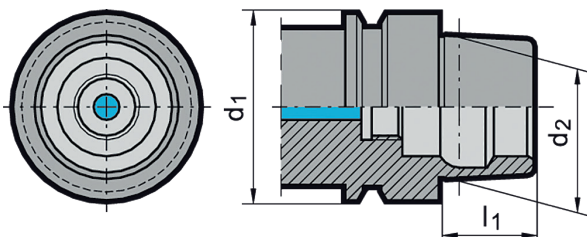

DIN 69063-6 Form F

For high-speed applications mainly in woodworking industries. HSK for automatic tool change. Torque is transmitted through highly accurate connection. Version with access hole acc. to DIN 69893-1 by arrangement.

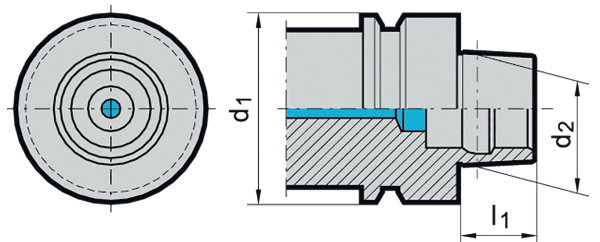



HSK form A, -B or -D holders must be equipped with a coolant tube.

Using holders without a coolant tube could cause unseen machine spindle damage.

DIN 69893 Form C, -E and -F do not require a coolant tube. Through coolant and sealing functions are provided by the locking unit.

The coolant tube is ideally mounted in vertical direction – from the bottom to the top. In this manner the sealing ring is prevented from being compressed during location which would cause the loss of its sealing function.

After mounting, the coolant pipe can be moved only to a minimum degree according to DIN ($\pm 1^\circ$).

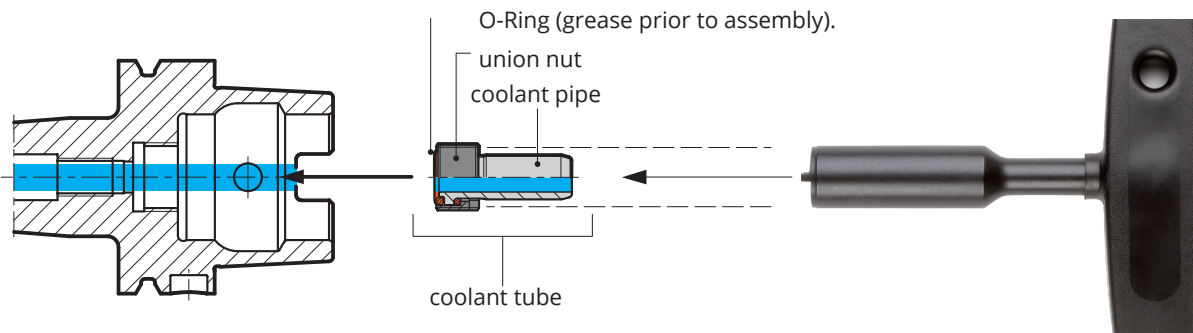

Installation

1. The HSK holder must be clean, free of swarf and undamaged.
2. Grease the O-rings prior to assembly.
3. Centrally insert the complete coolant tube (coolant pipe, union nut and 2 O-rings) in the HSK with the assistance of the socket spanner.
4. Screw in the coolant tube and tighten (see table for torque figures)
5. Check coolant pipe for radial mobility.

Torque figures

for HSK	Mt (Nm)
32	7
40	11
50	15
63	20
80	25
100	30