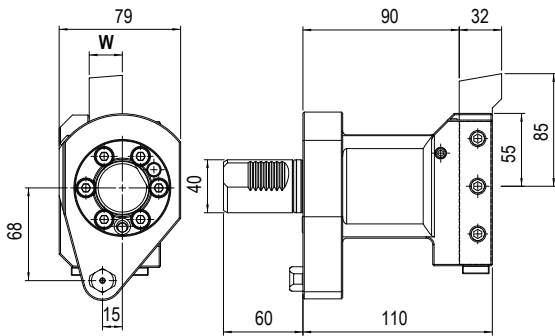

MODELLI DI TORNIO COMPATIBILI
 COMPATIBLE LATHE TYPES

MAZAK

Vedi pagine compatibilità 6.4 / 6.5 - See compatibility pages 6.4 / 6.5

VDI40
QTN1

TIPO - TYPE

Portautensile per sfacciare
Facing tool holder

 REFRIGERANTE
 COOLANT
Esterno
 External

Code	W	
T.53518000301	20	

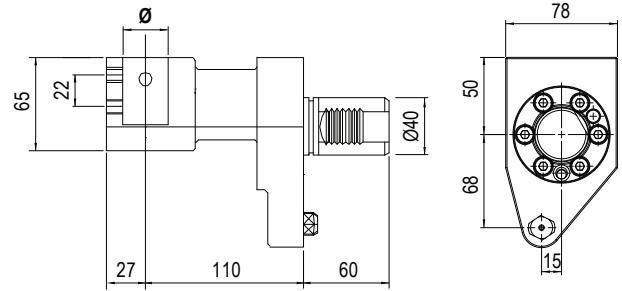

TIPO - TYPE

Portapunte
U'Drill holder

 REFRIGERANTE
 COOLANT
Esterno & Interno
 External & Internal

Code	Ø	
T.53518000501	32	

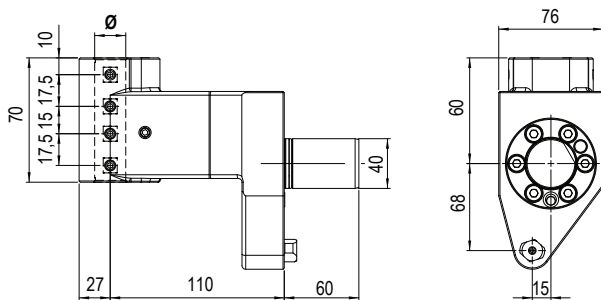

TIPO - TYPE

Portabareno doppio
Double boring bar holder

 REFRIGERANTE
 COOLANT
Esterno
 External

Code	Ø	
T.53538000201	20	

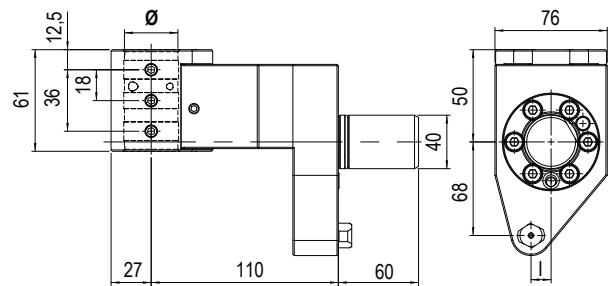

TIPO - TYPE

Portabareno
Boring bar holder

 REFRIGERANTE
 COOLANT
Esterno
 External

Code	Ø	
T.53518000201	32	

BMT - QTN1 Ø32



Code

T.53108000400



Code

T.53108000500

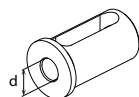

Ød	Code
Ø8	T.B.C3208K
Ø10	T.B.C3210K
Ø12	T.B.C3212K

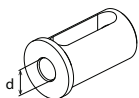

Ød	Code
Ø16	T.B.D3216K
Ø20	T.B.D3220K
Ø25	T.B.D3225K

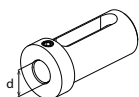

Ød	Code
Ø16	T.B.E3216K
Ø20	T.B.E3220K
Ø25	T.B.E3225K

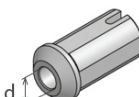

Ød	Code
Ø12,065	T.B.MZ.MT1
Ø17,78	T.B.MZ.MT2

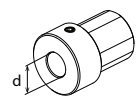

Ød	Code
Ø20	T.B.MZ3220G
Ø25	T.B.MZ3225G

BMT - QTN2 Ø40



Code

T.53108000400



Code

T.53208000100
T.53108000500

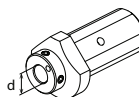

Ød	Code
Ø8	*53178010700
Ø10	*53178010600
Ø12	*53178010500
Ø16	*53178010400
Ø20	*53178010300

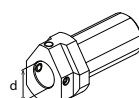

Ød	Code
Ø25	*53178010200
Ø32	*53178010100

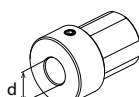

Ød	Code
Ø20	*53208001000
Ø25	*53208001100
Ø32	*53208001200

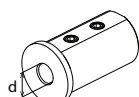

Ød	Code
Ø8	T.B.C4008K
Ø10	T.B.C4010K
Ø12	T.B.C4012K

BMT 68 Ø40

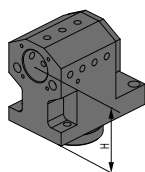

Code

137-00277

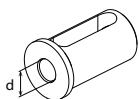

Ød	Code
Ø16	T.B.D.4016K
Ø20	T.B.D.4020K
Ø25	T.B.D.4025K
Ø32	T.B.D.4032K

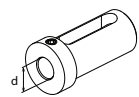

Ød	Code
Ø16	T.B.E4016k
Ø20	T.B.E4020k
Ø25	T.B.E4025k
Ø32	T.B.E4032k

VDI 40



Code

T.53538000201
T.53518000201



Code

T.53638000400



Code

T.532080005100



Code

T.532080005100

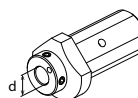

Ød	Code
Ø8	*53178010700
Ø10	*53178010600
Ø12	*53178010500
Ø16	*53178010400
Ø20	*53178010300

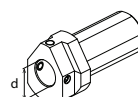

Ød	Code
Ø25	*53178010200
Ø32	*53178010100

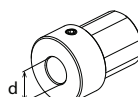

Ød	Code
Ø20	*53208001000
Ø25	*53208001100
Ø32	*53208001200
Ø20	T.B.MZ3220G
Ø25	T.B.MZ3225G

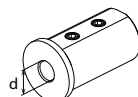

Ød	Code
Ø8	T.B.C4008K
Ø10	T.B.C4010K
Ø12	T.B.C4012K

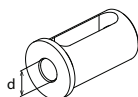

Ød	Code
Ø16	T.B.D.4016K
Ø20	T.B.D.4020K
Ø25	T.B.D.4025K
Ø32	T.B.D.4032K

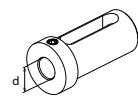

Ød	Code
Ø16	T.B.E4016k
Ø20	T.B.E4020k
Ø25	T.B.E4025k
Ø32	T.B.E4032k

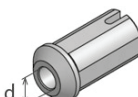

Ød	Code
Ø12,065	T.B.MZ.MT1
Ø17,78	T.B.MZ.MT2

VDI 50

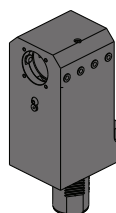

Code

T.53308000201

BMT & VDI Static Tools

STATIC TOOLS

Portautensili statici per torrette VDI e BMT !

Static tools for VDI & BMT turrets !

Viene proposta un'ampia gamma di modelli adatti ad attrezzare i torni e le torrette dei maggiori costruttori a livello mondiale, come BIGLIA, BMT, DMG MORI, GOODWAY, HAAS, MAZAK, MIYANO, NAKAMURA, OKUMA, TSUGAMI e VDI DIN69880.

The company proposes a wide range of suitable Driven Tools for equipping the lathes turrets by world leader manufacturers, such as BIGLIA, BMT, DMG MORI, GOODWAY, HAAS, MAZAK, MIYANO, NAKAMURA, OKUMA, TSUGAMI and VDI DIN69880.

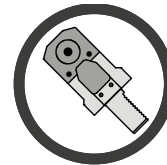

Maximum precision both for turning and drilling and boring!

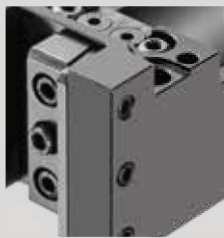

Treatment anti corrosion Anti-corrosion treatment

I Portautensili statici sono costruiti con acciaio rettificato altamente legato e sono sottoposti ad un trattamento anti-corrosione

Static toolholders are produced with certified top quality steel and are subjected to an anti-corrosion treatment

BMT Stelo quadro radiale
BMT radial face and cutting holder

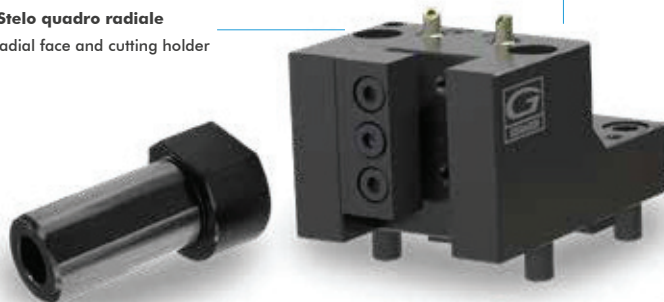

BMT Portabareno
BMT Boring bar holder



 **Refrigerante esterno standard**
External Coolant standard



VDI B2 Portautensile radiale Sinistro
VDI B2 Left radial holder



VDI E2 Portabareno
VDI E2 Boring bar holder



Bussole Porta-bareni Boring bar Sleeves

Le bussole portabareno vengono impiegate su tutte le tipologie di tornio. Possono essere fornite con grani e asole, con battuta, prolungate o ridotte.

The boring bar sleeves are used on all types of lathe. They can be supplied with screw and slot, with collar, extended or reduced.