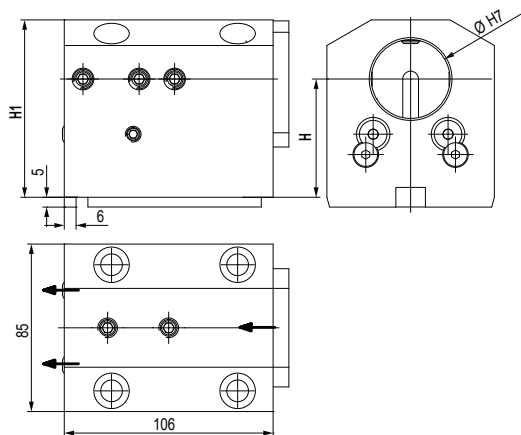

**MODELLI DI TORNIO COMPATIBILI**  
**COMPATIBLE LATHE TYPES**
**DOOSAN**
**HWACHEON**
**HYUNDAI WIA**
**SAMSUNG**
**VICTOR**

Vedi pagine compatibilità 6.4 / 6.5 - See compatibility pages 6.4 / 6.5

**BMT**  
**55**

 TIPO - TYPE  
**Portabareno**  
 Boring bar cutting holder

 REFRIGERANTE  
 COOLANT  
**Esterno & Interno**  
 External & Internal

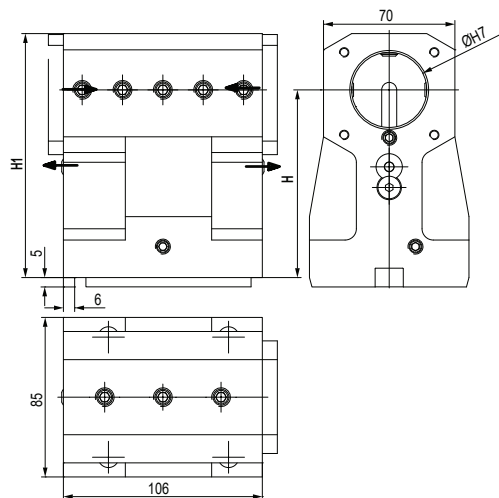
Code	Ø	H	H1	
T.BMT.55BBC4060K	40	60±0.02	90	

 TIPO - TYPE  
**Portabareno**  
 Boring bar cutting holder

 REFRIGERANTE  
 COOLANT  
**Esterno & Interno**  
 External & Internal

Code	Ø	H	H1	
T.BMT.55BBC40100K	40	100±0.02	130	

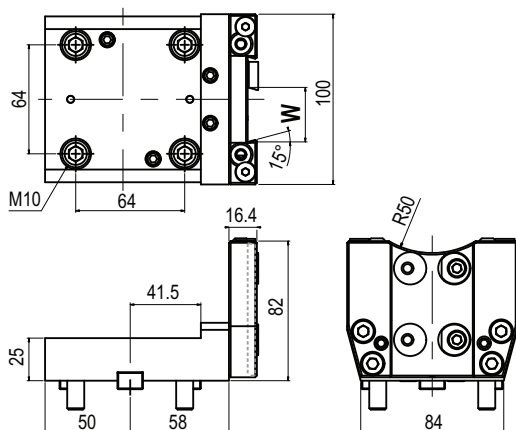
 TIPO - TYPE  
**Porta Lama**  
 Cut off holder

 REFRIGERANTE  
 COOLANT  
**Esterno**  
 External

Code	W	
T.BMT.55H12600H	26	
T.BMT.55H13200H	32	

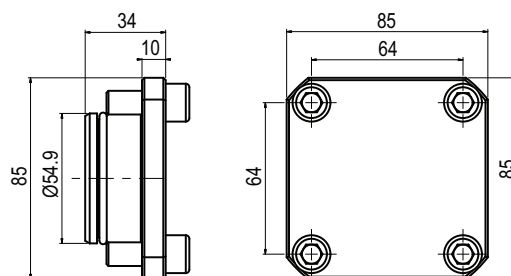
 TIPO - TYPE  
**Tappo in acciaio**  
 Steel Turret Cup

Code	
T.BMT.55Z10000H	

BMT 45 - 55 - 65 - 75 - 85

**BMT45 Ø20-Ø32**



Code

T.BMT.45BB3265H



Code

T.BMT.45BBD20H

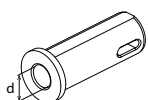

Ød	Code
Ø32	T.B.F32.MT1
Ø32	T.B.F32.MT2

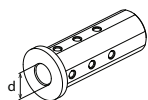

Ø8	T.B.A3208G
Ø10	T.B.A3210G
Ø12	T.B.A3212G
Ø16	T.B.A3216G
Ø20	T.B.A3220G

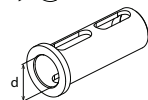

Ø25	T.B.B3225G
-----	------------

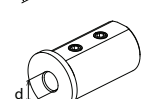

Ø16	T.B.D3216K
Ø20	T.B.D3220K
Ø25	T.B.D3225K

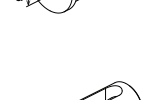

Ø8	T.B.E2008K
Ø10	T.B.E2010K
Ø12	T.B.E2012K
Ø16	T.B.E2016K
Ø16	T.B.E3216K
Ø20	T.B.E3220K
Ø25	T.B.E3225K

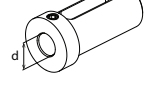

**BMT55 Ø40**



Code

T.BMT.55BB4070H



Code

T.BMT.55BBC4060K  
T.BMT.55BBC40100K

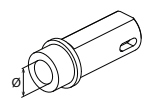

Ød	Code
-	T.B.L.MT1
-	T.B.L.MT2
-	T.B.L.MT3

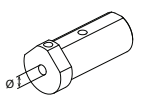

Ød	Code
Ø10	T.B.M4010G
Ø12	T.B.M4012G
Ø16	T.B.M4016G

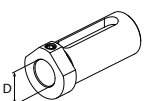

Ød	Code
Ø20	T.B.DS14020G
Ø25	T.B.DS14025G
Ø32	T.B.DS14032G

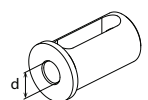

Ød	Code
Ø20	T.B.DS24020G
Ø25	T.B.DS24025G
Ø32	T.B.DS24032G

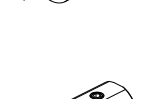

Ød	Code
Ø8	T.B.C4008K
Ø10	T.B.C4010K
Ø12	T.B.C4012K

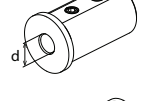

Ød	Code
Ø16	T.B.D.4016K
Ø20	T.B.D.4020K
Ø25	T.B.D.4025K
Ø32	T.B.D.4032K

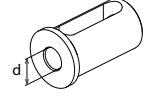

Ød	Code
Ø16	T.B.E4016G
Ø20	T.B.E4020G
Ø25	T.B.E4025G
Ø32	T.B.E4032G

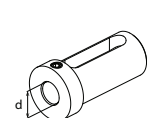

DOOSAN / HARDINGE / SAMSUNG / HWACHEON  
HYUNDAI WIA / VICTOR / HAAS / GOODWAY / JYOTI

**BMT65/75 Ø40/50**



Code

T.BMT.65BBC4072H  
T.BMT.65BBC40100H

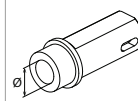

Ød	Code
-	T.B.L.MT1
-	T.B.L.MT2
-	T.B.L.MT3

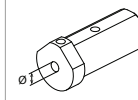

Ød	Code
Ø10	T.B.M4010G
Ø12	T.B.M4012G
Ø16	T.B.M4016G

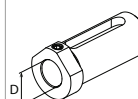

Ød	Code
Ø20	T.B.DS14020G
Ø25	T.B.DS14025G
Ø32	T.B.DS14032G

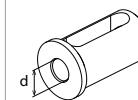

Ød	Code
Ø20	T.B.DS24020G
Ø25	T.B.DS24025G
Ø32	T.B.DS24032G

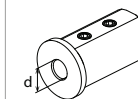

Ød	Code
Ø8	T.B.C4008K
Ø10	T.B.C4010K
Ø12	T.B.C4012K

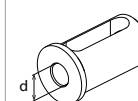

Ød	Code
Ø16	T.B.D.4016K
Ø20	T.B.D.4020K
Ø25	T.B.D.4025K
Ø32	T.B.D.4032K



Ød	Code
Ø16	T.B.E4016k
Ø20	T.B.E4020k
Ø25	T.B.E4025k
Ø32	T.B.E4032k

**BMT85 Ø60**



Code

T.BMT.75BBC60110H

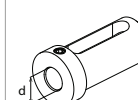

Ød	Code
Ø25	T.B.E5025k
Ø32	T.B.E5032k
Ø40	T.B.E5040k

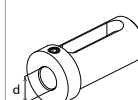

Ød	Code
Ø25	T.B.E6025k
Ø32	T.B.E6032k
Ø40	T.B.E6040k
Ø50	T.B.E6050k

## BMT & VDI Static Tools

# STATIC TOOLS

### Portautensili statici per torrette VDI e BMT !

#### Static tools for VDI & BMT turrets !

Viene proposta un'ampia gamma di modelli adatti ad attrezzare i torni e le torrette dei maggiori costruttori a livello mondiale, come BIGLIA, BMT, DMG MORI, GOODWAY, HAAS, MAZAK, MIYANO, NAKAMURA, OKUMA, TSUGAMI e VDI DIN69880.

The company proposes a wide range of suitable Driven Tools for equipping the lathes turrets by world leader manufacturers, such as BIGLIA, BMT, DMG MORI, GOODWAY, HAAS, MAZAK, MIYANO, NAKAMURA, OKUMA, TSUGAMI and VDI DIN69880.

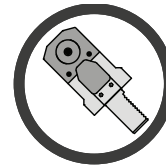

*Maximum precision both for turning and drilling and boring!*

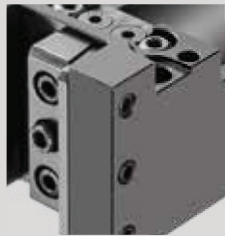

#### Treatment anti corrosion Anti-corrosion treatment

I Portautensili statici sono costruiti con acciaio rettificato altamente legato e sono sottoposti ad un trattamento anti-corrosione

Static toolholders are produced with certified top quality steel and are subjected to an anti-corrosion treatment

#### BMT Stelo quadro radiale

BMT radial face and cutting holder

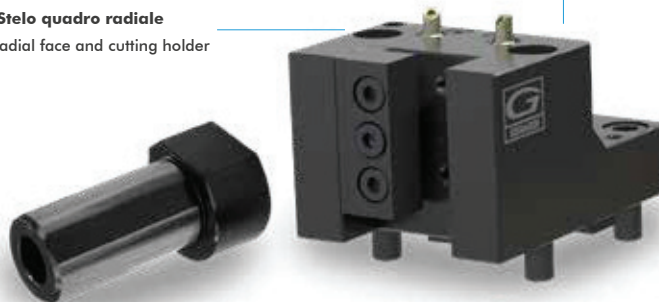

#### BMT Portabareno

BMT Boring bar holder



Refrigerante esterno standard  
External Coolant standard



VDI B2 Portautensile radiale Sinistro  
VDI B2 Left radial holder



VDI E2 Portabareno  
VDI E2 Boring bar holder



#### Bussole Porta-bareni Boring bar Sleeves

Le bussole portabareno vengono impiegate su tutte le tipologie di tornio. Possono essere fornite con grani e asole, con battuta, prolungate o ridotte.

The boring bar sleeves are used on all types of lathe. They can be supplied with screw and slot, with collar, extended or reduced.

PIÙ SEMPLICE / PIÙ INFO / PIÙ PRODOTTI - EASIER / MORE INFO / MORE PRODUCTS

TROVA IL TUO PRODOTTO IN POCHI CLICK - FIND YOUR PRODUCT IN FEW CLICKS

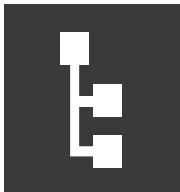

by category



by code



by description

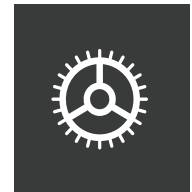

by configurator

## Un nuovo modo facile e veloce per ordinare la tua attrezzatura Gerardi

Il nuovo Gerardi estore offre la possibilità di visualizzare e ordinare qualsiasi articolo Gerardi appartenente alle categorie Workholding o Tooling presente sui nostri listini in modo semplice, veloce e completo. Da ora puoi ordinare la morsa, la testa angolare o il motorizzato che ti interessa direttamente on-line dal nostro estore senza costi aggiuntivi.

## A new quick and easy way to order your equipment branded Gerardi.

The new Gerardi estore offers the ability to view and order any item available on our Workholding and Tooling catalogues with the easiest, fastest and comprehensive way. You can now order the vise, angle head or driven tool of your interest directly online from our store without any additional cost.

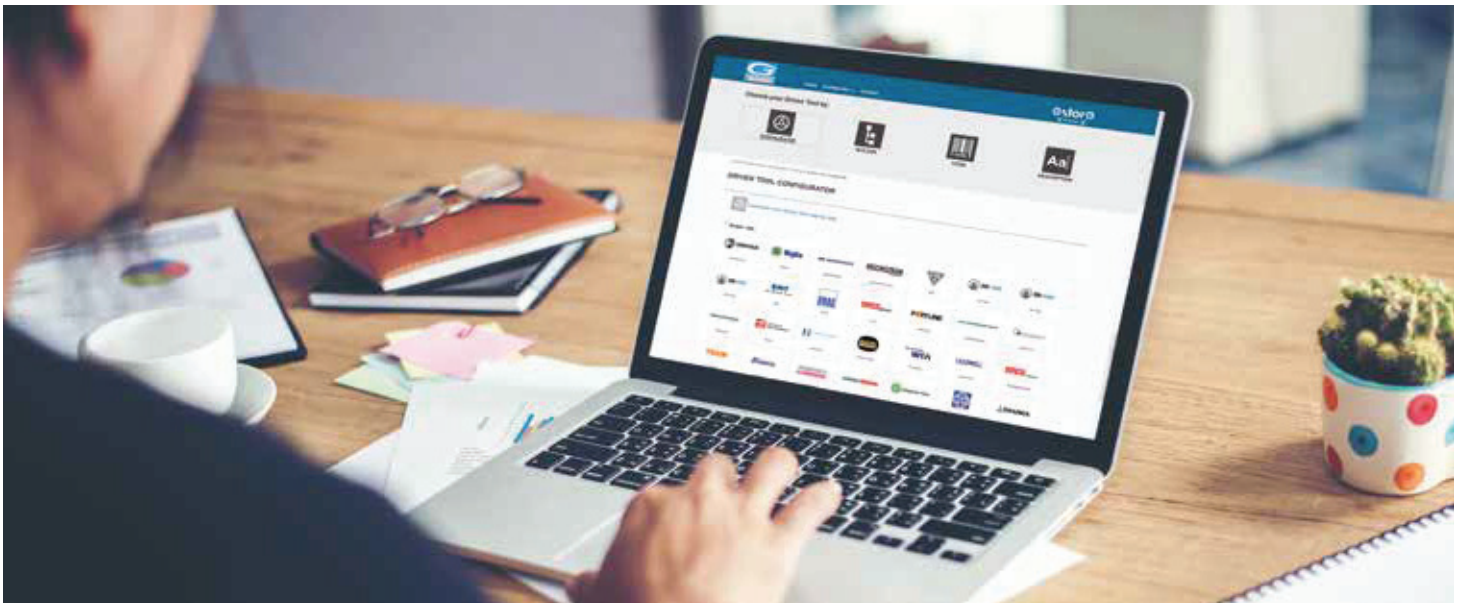

WINDOWS / IOS



ANDROID / IPHONE

