

MODELLI DI TORNIO COMPATIBILI
COMPATIBLE LATHE TYPES

DOOSAN

HWACHEON

HYUNDAI WIA

SAMSUNG

VICTOR

HAAS

MAXIS

TONGAI

Vedi pagine compatibilità 6.4 / 6.5 - See compatibility pages 6.4 / 6.5

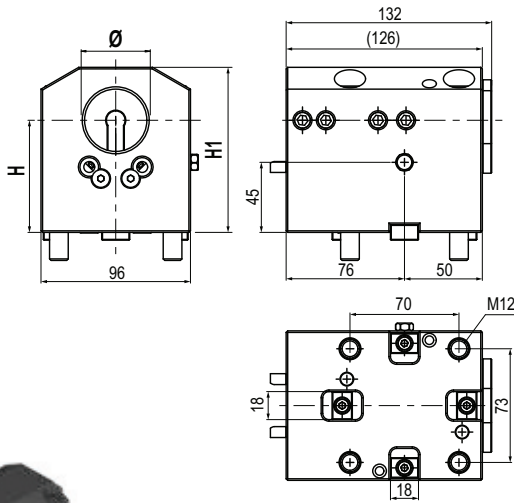
 TIPO - TYPE
Portabareno
 Boring bar cutting holder

 REFRIGERANTE
 COOLANT
Esterno & Interno
 External & Internal

Code	Ø	H	H1	
T.BMT.65BBC4072H	40	72	106	
T.BMT.65BBC40100H	40	100	140	

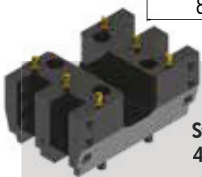
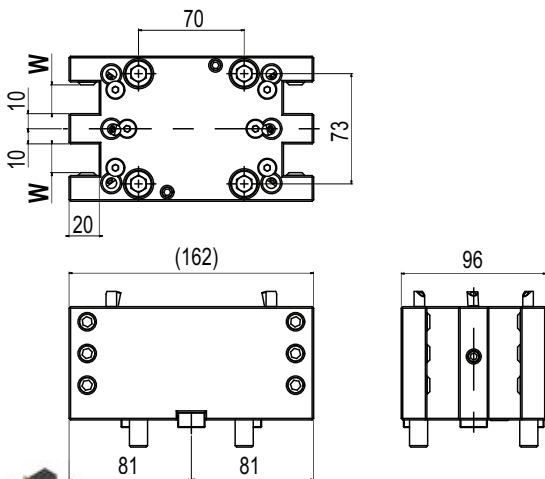
 TIPO - TYPE
Stelo quadro rad. quadruplo
 4 RD face and cutting holder

 REFRIGERANTE
 COOLANT
Esterno
 External

Code	W	
T.BMT.65C2D2020H	20	
T.BMT.65C2D2525H	25	

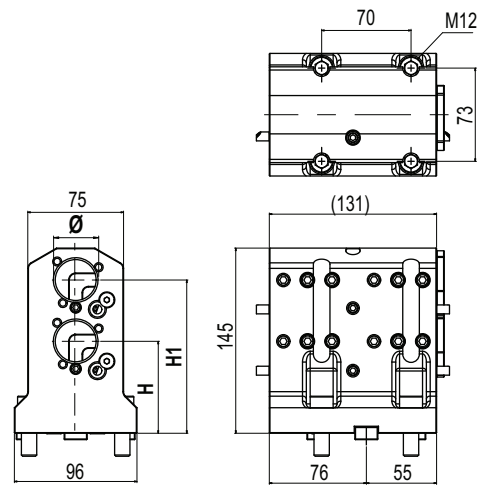
BMT
65

 TIPO - TYPE
Portabareno doppio
 Double boring bar holder

 REFRIGERANTE
 COOLANT
Esterno & Interno
 External & Internal

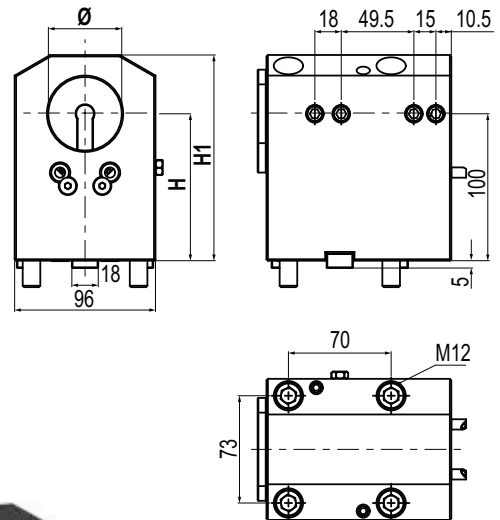
Code	Ø	H	H1	
T.BMT.65BBD32H	32	72	120	

 TIPO - TYPE
Portabareno
 Boring bar cutting holder

 REFRIGERANTE
 COOLANT
Esterno & Interno
 External & Internal

Code	Ø	H	H1	
T.BMT.65BBC5072H	50	72	106	
T.BMT.65BBC50100H	50	100	140	

6

BMT 45 - 55 - 65 - 75 - 85

BMT45 Ø20-Ø32



Code

T.BMT.45BB3265H



Code

T.BMT.45BBD20H

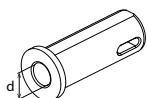

Ød	Code
Ø32	T.B.F32.MT1
Ø32	T.B.F32.MT2

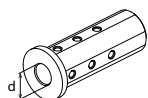

Ø8	T.B.A3208G
Ø10	T.B.A3210G
Ø12	T.B.A3212G
Ø16	T.B.A3216G
Ø20	T.B.A3220G

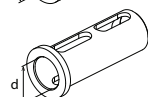

Ø25	T.B.B3225G
-----	------------

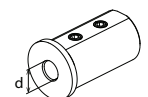

Ø16	T.B.D3216K
Ø20	T.B.D3220K
Ø25	T.B.D3225K

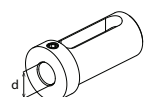

Ø8	T.B.E2008K
Ø10	T.B.E2010K
Ø12	T.B.E2012K
Ø16	T.B.E2016K
Ø16	T.B.E3216K
Ø20	T.B.E3220K
Ø25	T.B.E3225K

BMT55 Ø40



Code

T.BMT.55BB4070H



Code

T.BMT.55BBC4060K
T.BMT.55BBC40100K

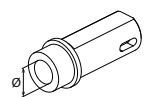

Ød	Code
-	T.B.L.MT1
-	T.B.L.MT2
-	T.B.L.MT3

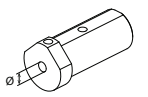

Ød	Code
Ø10	T.B.M4010G
Ø12	T.B.M4012G
Ø16	T.B.M4016G

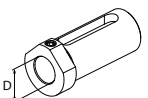

Ød	Code
Ø20	T.B.DS14020G
Ø25	T.B.DS14025G
Ø32	T.B.DS14032G

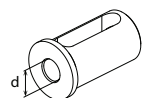

Ød	Code
Ø20	T.B.DS24020G
Ø25	T.B.DS24025G
Ø32	T.B.DS24032G

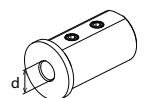

Ød	Code
Ø8	T.B.C4008K
Ø10	T.B.C4010K
Ø12	T.B.C4012K

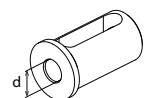

Ød	Code
Ø16	T.B.D.4016K
Ø20	T.B.D.4020K
Ø25	T.B.D.4025K
Ø32	T.B.D.4032K

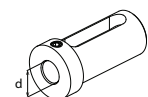

Ød	Code
Ø16	T.B.E4016G
Ø20	T.B.E4020G
Ø25	T.B.E4025G
Ø32	T.B.E4032G

DOOSAN / HARDINGE / SAMSUNG / HWACHEON
HYUNDAI WIA / VICTOR / HAAS / GOODWAY / JYOTI

BMT65/75 Ø40/50



Code

T.BMT.65BBC4072H
T.BMT.65BBC40100H

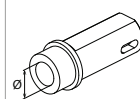

Ød	Code
-	T.B.L.MT1
-	T.B.L.MT2
-	T.B.L.MT3

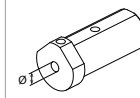

Ød	Code
Ø10	T.B.M4010G
Ø12	T.B.M4012G
Ø16	T.B.M4016G

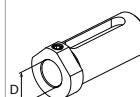

Ød	Code
Ø20	T.B.DS14020G
Ø25	T.B.DS14025G
Ø32	T.B.DS14032G

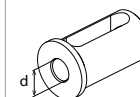

Ød	Code
Ø20	T.B.DS24020G
Ø25	T.B.DS24025G
Ø32	T.B.DS24032G

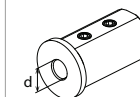

Ød	Code
Ø8	T.B.C4008K
Ø10	T.B.C4010K
Ø12	T.B.C4012K

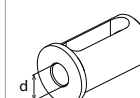

Ød	Code
Ø16	T.B.D.4016K
Ø20	T.B.D.4020K
Ø25	T.B.D.4025K
Ø32	T.B.D.4032K



Ød	Code
Ø16	T.B.E4016k
Ø20	T.B.E4020k
Ø25	T.B.E4025k
Ø32	T.B.E4032k

BMT85 Ø60



Code

T.BMT.75BBC60110H

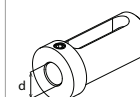

Ød	Code
Ø25	T.B.E5025k
Ø32	T.B.E5032k
Ø40	T.B.E5040k

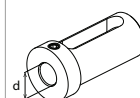

Ød	Code
Ø25	T.B.E6025k
Ø32	T.B.E6032k
Ø40	T.B.E6040k
Ø50	T.B.E6050k

BMT & VDI Static Tools

STATIC TOOLS

Portautensili statici per torrette VDI e BMT !

Static tools for VDI & BMT turrets !

Viene proposta un'ampia gamma di modelli adatti ad attrezzare i torni e le torrette dei maggiori costruttori a livello mondiale, come BIGLIA, BMT, DMG MORI, GOODWAY, HAAS, MAZAK, MIYANO, NAKAMURA, OKUMA, TSUGAMI e VDI DIN69880.

The company proposes a wide range of suitable Driven Tools for equipping the lathes turrets by world leader manufacturers, such as BIGLIA, BMT, DMG MORI, GOODWAY, HAAS, MAZAK, MIYANO, NAKAMURA, OKUMA, TSUGAMI and VDI DIN69880.

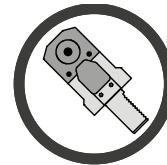

Maximum precision both for turning and drilling and boring!

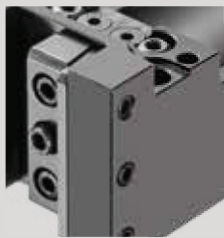

Treatment anti corrosion Anti-corrosion treatment

I Portautensili statici sono costruiti con acciaio rettificato altamente legato e sono sottoposti ad un trattamento anti-corrosione

Static toolholders are produced with certified top quality steel and are subjected to an anti-corrosion treatment

BMT Stelo quadro radiale
BMT radial face and cutting holder

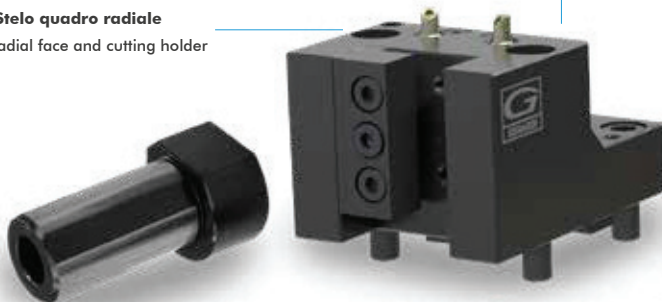

BMT Portabareno
BMT Boring bar holder



 **Refrigerante esterno standard**
External Coolant standard



VDI B2 Portautensile radiale Sinistro
VDI B2 Left radial holder



VDI E2 Portabareno
VDI E2 Boring bar holder



Bussole Porta-bareni Boring bar Sleeves

Le bussole portabareno vengono impiegate su tutte le tipologie di tornio. Possono essere fornite con grani e asole, con battuta, prolungate o ridotte.

The boring bar sleeves are used on all types of lathe. They can be supplied with screw and slot, with collar, extended or reduced.