

# RICAMBI PER GANASCE CON PIASTRE PIANE / SPARES FOR STRAIGHT JAW PLATES

Tipo (grandezza) morsa / Vise type (size)	1	2	3	4	5	6
---	---	---	---	---	---	---

**PIASTRE PIANE TEMPRATE, RIGATE O QUADRETTATE**
**HARDENED GROOVED OR SERRATED STRAIGHT JAW PLATES**

 Dotazione normale delle ganasce e delle morse complete  
 Standard equipment on complete jaws and vises

Per qualsiasi piastra ganascia speciale, raddoppiare il prezzo / For special tailor made jaw plate double the price

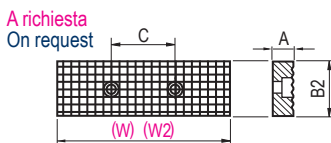
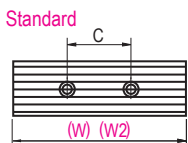
**Art. 242**
**Art. 242S**

 Per ganascia fissa e mobile - Art. 140, 143, 146 - **Larghezza normale (W)**  
 For fixed and movable jaw - Art. 140, 143, 146 - **Normal width (W)**

W	100	125	150	175	200	300
W2	74	94	124	144	169	194
A	12	12	13	13	18	18
B2	24,5	32	40	43	48	56
C	25	32	50	50	76	90

Cod. Art. 242	1.65.16000	1.65.26000	1.65.36000	1.65.46000	1.65.56000	1.65.66000
Cod. Art. 242S	4.24.2S100	4.24.2S200	4.24.2S300	4.24.2S400	4.24.2S500	4.24.2S600

**Art. 243**
**Art. 243S**

 Per ganascia fissa e mobile - Art. 141, 144, 147 - **Larghezza ridotta (W2)**  
 For fixed and movable jaw - Art. 141, 144, 147 - **Narrow width (W2)**

Cod. Art. 243	1.65.17000	1.65.27000	1.65.37000	1.65.47000	1.65.57000	1.65.67000
Cod. Art. 243S	4.24.3S100	4.24.3S200	4.24.3S300	4.24.3S400	4.24.3S500	4.24.3S600

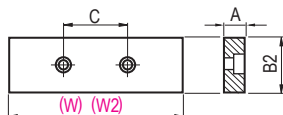
**PIASTRE PIANE LISCE TEMPRATE**
**HARDENED SMOOTH STRAIGHT JAW PLATES**

**Art. 244**

 Per ganascia fissa e mobile - Art. 140, 143, 146 - **Larghezza normale (W)**  
 For fixed and movable jaw - Art. 140, 143, 146 - **Normal width (W)**

Cod. Art. 244	4.24.41000	4.24.42000	4.24.43000	4.24.44000	4.24.45000	4.24.46000
---------------	------------	------------	------------	------------	------------	------------

**Art. 245**

 Per ganascia fissa e mobile - Art. 141, 144, 147 - **Larghezza ridotta (W2)**  
 For fixed and movable jaw - Art. 141, 144, 147 - **Narrow width (W2)**

Cod. Art. 245	4.24.51000	4.24.52000	4.24.53000	4.24.54000	4.24.55000	4.24.56000
---------------	------------	------------	------------	------------	------------	------------

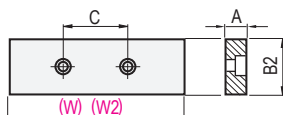
**PIASTRE PIANE IN ACCIAIO LAVORABILE (DOLCE)**
**MACHINEABLE STEEL STRAIGHT JAW PLATES (SOFT HRC)**

**Art. 246**

 Per ganascia fissa e mobile - Art. 140, 143, 146 - **Larghezza normale (W)**  
 For fixed and movable jaw - Art. 140, 143, 146 - **Normal width (W)**

Cod. Art. 246	1.65.16200	1.65.26200	1.65.36200	1.65.46200	1.65.56200	1.65.66200
---------------	------------	------------	------------	------------	------------	------------

**Art. 247**

 Per ganascia fissa e mobile - Art. 141, 144, 147 - **Larghezza ridotta (W2)**  
 For fixed and movable jaw - Art. 141, 144, 147 - **Narrow width (W2)**

Cod. Art. 247	1.65.17200	1.65.27200	1.65.37200	1.65.47200	1.65.57200	1.65.67200
---------------	------------	------------	------------	------------	------------	------------

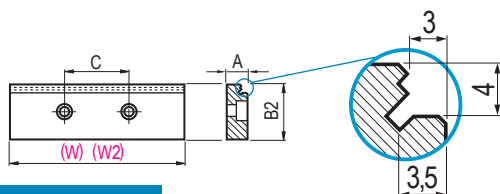
**PIASTRE PIANE TEMPRATE GRIP**
**HARDENED STRAIGHT JAW PLATES GRIP**

**PIASTRE GANASCE "GRIP" JAW PLATES**
**MINOR SUPERFICIE DI CONTATTO + PRESSIONE DI SERRAGGIO**
**LESS SURFACE CONTACT + CLAMPING PRESSURE**
**Art. 246T**

 Per ganascia fissa e mobile - Art. 140, 143, 146 - **Larghezza normale (W)**  
 For fixed and movable jaw - Art. 140, 143, 146 - **Normal width (W)**

Cod. Art. 246T	4.24.6T100	4.24.6T200	4.24.6T300	4.24.6T400	4.24.6T500	4.24.6T600
----------------	------------	------------	------------	------------	------------	------------

**Art. 247T**

 Per ganascia fissa e mobile - Art. 141, 144, 147 - **Larghezza ridotta (W2)**  
 For fixed and movable jaw - Art. 141, 144, 147 - **Narrow width (W2)**

Cod. Art. 247T	4.24.7T100	4.24.7T200	4.24.7T300	4.24.7T400	4.24.7T500	4.24.7T600
----------------	------------	------------	------------	------------	------------	------------

## Parti di ricambio / Spare parts

# STD / StdFLEX / XL

**Un'ampia scelta di componenti ed accessori modulari !**

**Wide range of components and modular accessories !**

### USURA INESISTENTE / NO WEAR

Grazie all'accurata scelta dei materiali impiegati ed allo studio dimensionale computerizzato dei componenti. Costruzione completamente in speciali leghe di acciaio ad alta resistenza, normalizzato, cementato e temprato con durezza 58 ±2 HRC. Tutto ciò al fine di conferire massima rigidità, elevate prestazioni e usura inesistente. A riprova di tutto ciò assicuriamo **5 ANNI DI GARANZIA** su tutto il programma morse e organi meccanici in genere.

Thanks to the manufacturing with only the most suitable materials and to the structure of the vise components (developed using computer customised softwares and the experience gained during many years spent working on the specific field). High alloyed quality resistance steel, case hardened HRC 58 ±2, is used in manufacturing all the Gerardi vises and accessories in order to give maximum rigidity, high performances and no wear. As evidence we give **5 YEARS WARRANTY** on all the vises and mechanical components.

### MODULARITÀ / MODULARITY

Tutte le morse ed accessori sono elementi componibili, intercambiabili e perfettamente allineabili fra loro e con i quali è possibile ottenere differenti soluzioni di bloccaggio. Secondo tale principio l'unico elemento che differenzia le attrezzature con identica larghezza di presa è la base (la cui lunghezza determina la massima apertura della morsa), mentre gli altri componenti sono identici. Mediante l'aggiunta o semplice sostituzione di alcuni particolari si può variare la tipologia di bloccaggio secondo le proprie esigenze utilizzando la stessa attrezzatura acquistata in un primo momento (bloccaggi singoli, con base girevole, doppi, verticali, di pezzi piani, tondi, piatti e grezzi, manuali, idraulici o pneumatici).

All vises and accessories are modular and components of all our vises will interchange with perfect alignment to provide different workholding solutions. With this basic principle the only difference between fixtures with the same width of clamping is the base (whose length determines the maximum opening of the vise), while the rest of components have same dimensions. Through the simple addition or substitution of some particulars You can change the type of clamping as Your needs require using the same fixture purchased before (single clamping, swivel base, double, vertical, smooth or round or flat or rough workpieces, manual, hydraulic or pneumatic).

### DESIGN COMPATTO / SPACE SAVING DESIGN

La semplicità nonché la compattezza costruttiva consentono un'apertura notevole rispetto all'ingombro totale dell'attrezzatura. Inoltre lo stesso peso (solo 25 kg per una morsa da 150 mm di larghezza ganasce) è tale da consentire un facile trasferimento da una macchina all'altra.

The space saving design and solid construction allow a maximum blocking ratio to total overall dimension of the vise. Furthermore the weight (only 25 kg for a 150 mm jaw width vise) allows a simple moving from one machine to another.

### SERRAGGI RAPIDI / QUICK CLAMPING

Grazie allo scorrimento del gruppo di serraggio nella guida della base (a cremagliera) fino in prossimità del pezzo da lavorare dove si adatterà automaticamente alla nicchia più vicina. L'operazione di serraggio si conclude agendo sulla vite di bloccaggio. Oltre a quello manuale meccanico, sono disponibili 4 ulteriori sistemi di serraggio intercambiabili e indipendenti: 1 - Idraulici / 2 - Pneumatici / 3 - Idraulici manuali / 4 - Idraulici elettrici. L'operazione è in termini di secondi.

Thanks to the clamping device sliding in the vise base slide (compact rack type) till the proximity of the workpiece. The clamping is completed with the main screw. Besides the manual mechanic system, 4 further interchangeable and independent clamping systems are available: 1- Hydraulic / 2- Pneumatic / 3- Manual hydraulic / 4- Electrical hydraulic. The change needs only few seconds.



#### Art.131 / 138 / 150

Ganasce Sovrapponibili  
Stack type jaws



#### Art.210

Ganasce mobili guidate monoblocco per pezzi tondi  
Solid guided movable jaws for round workpieces



#### Art.132 / 133

Prolunga per ganasce mobili e fisse  
Extension for movable and fixed jaws



#### Art.212

Ganasce mobile intermedia con doppio gradino  
Intermediate movable jaws with double step



#### Art.257 / 258 / 271

Gruppi di serraggio  
Spindle clamping devices

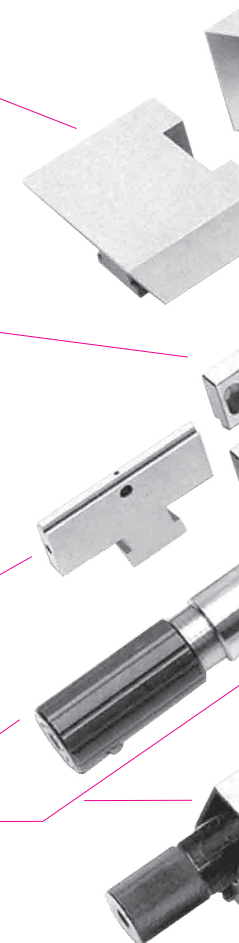

Sicuramente uno dei punti di forza del sistema modulare GERARDI consiste nell'ampissima scelta di componentistica ed accessori nonché nel continuo investimento e sviluppo nei più avanzati concetti e soluzioni originali. Il programma che viene presentato nelle pagine seguenti fa parte di un sistema modulare di bloccaggio fra i più ampi e completi a livello mondiale che permette realmente di trasformare in standard ciò che sembrerebbe essere speciale (oltre 1000 articoli moltiplicati per 6 grandezze diverse). Il segreto di tutto ciò sta proprio nella modularità del sistema che consente (con l'aggiunta di alcuni componenti) una più ampia gamma di impieghi.

One of the biggest point of strength of GERARDI modular system lies in the broadest assortment program of components and accessories and also in the continuous investment and development of the most advanced concepts and original solutions. The range of items shown in the following pages is part of a modular workholding system among the widest and complete in the world. So, any holding and clamping issue You ever have, You can solve it with Gerardi standard modular products. The secret lies just in the modularity of the system which allows (choosing different components) a wider range of solutions.



SCAN IT TO SEE



THE WEB PAGE



*Parallele, ganasce sovrapponibili,  
speciali e gruppi di serraggio  
intercambiabili*

*Parallel plates, stack type  
& special jaws and  
interchangeable clamping devices*

4

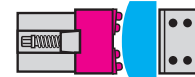
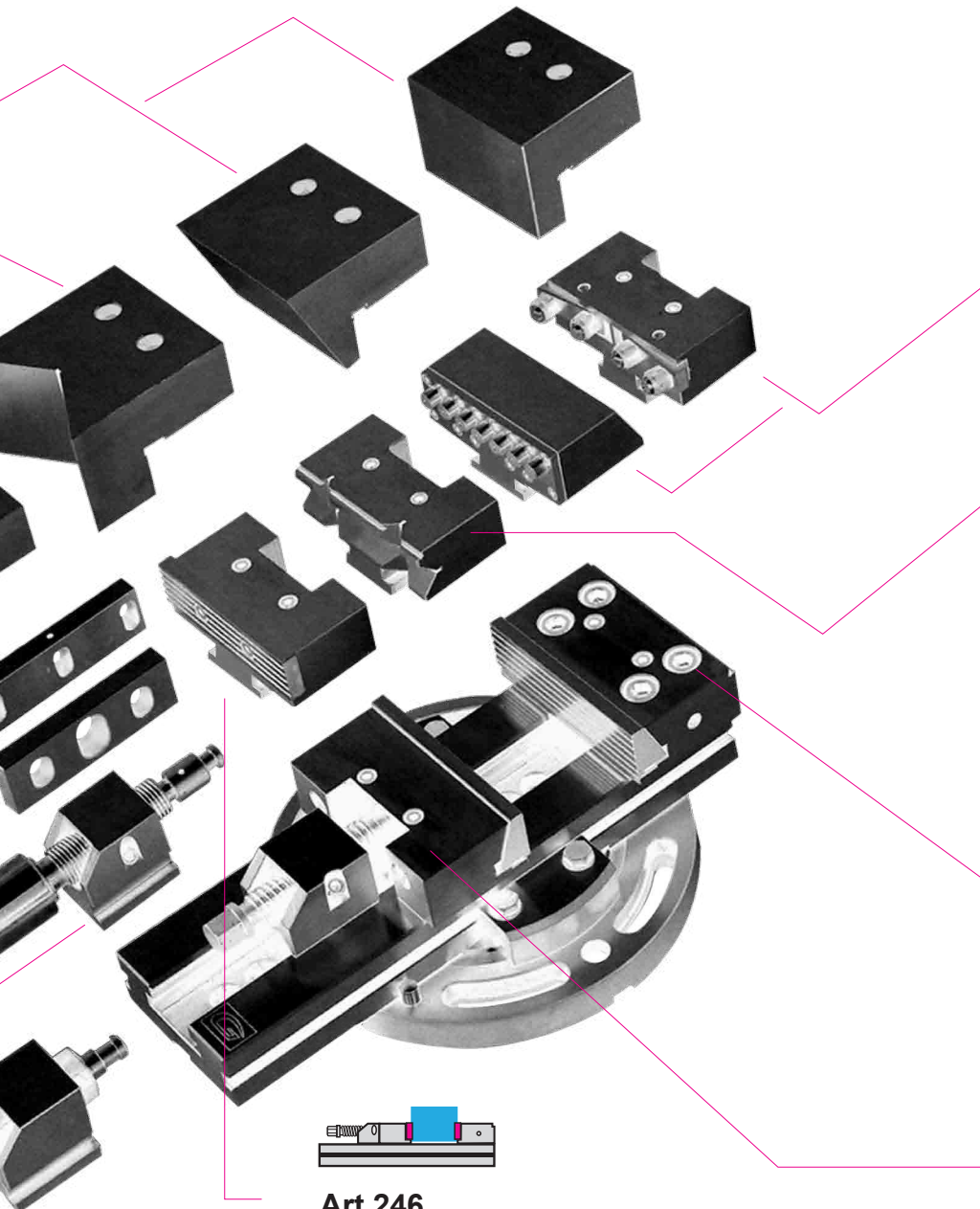
**Art.190 / 188**

Ganasce mobili guidate monoblocco  
Solid guided movable jaws

**Art.217**

Ganasce mobili guidate monoblocco prismatiche  
(per serraggio pezzi piatti e tondi)  
Solid guided movable prismatic jaws (for plates &  
round workpieces clamping)

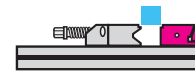
**Art.120**

Le ganasce fisse monoblocco consentono, una volta ruotate di 180°, il perfetto accoppiamento al gradino della ganascia prismatica mobile (Art. 217) ordinabile separatamente.

The solid standard fixed jaws with 5x5 mm back steps are matchable, if turned of 180°, to the prismatic movable jaw (Art.217) to be ordered separately.

**Art.127**

Ganascia mobili guidate monoblocco costruite con un angolo di spinta verso il basso.

Guided movable jaws built in one solid body with a pull down angle

**Art.246**

Ganasce mobili guidate monoblocco con piastre piane  
Solid guided movable jaw with straight plates

## Parti di ricambio / Spare parts

# Standard / StdFLEX / XL

### Piastre ganasce discendenti intercambiabili manualmente

Pull down jaws plates interchangeable by hand

4

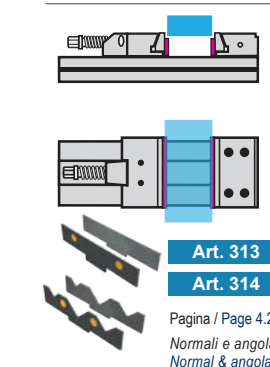
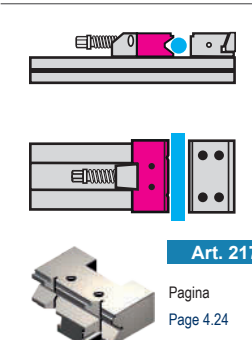
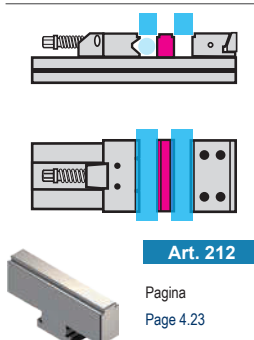
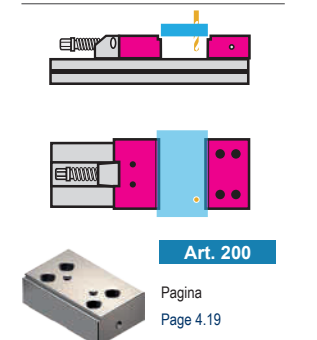
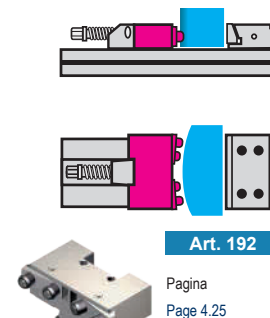
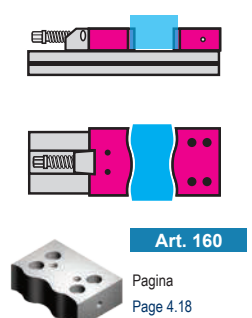
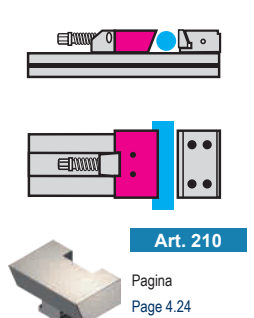
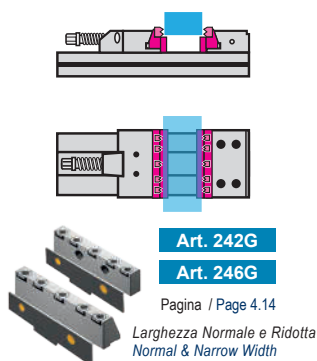

### PIASTRE GANASCE COMPATIBILI SOLO CON MORSE STDFLEX JAW PLATES COMPATIBLE ONLY WITH STDFLEX VISES

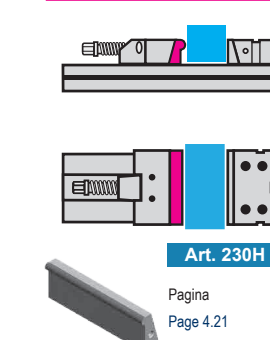
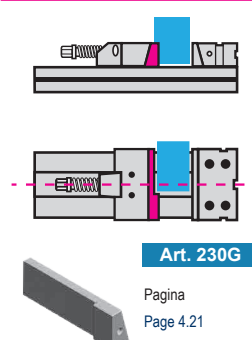
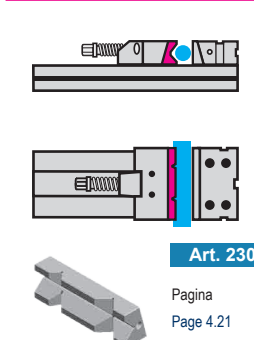
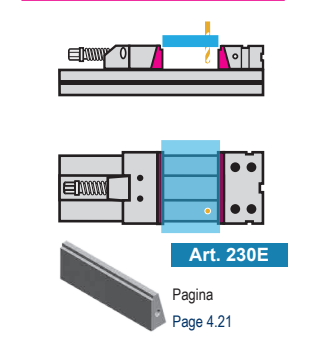
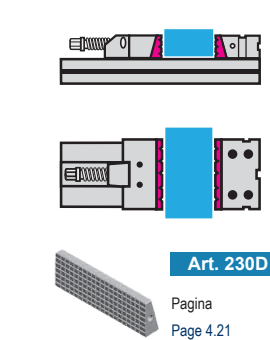
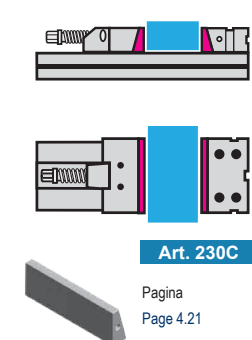
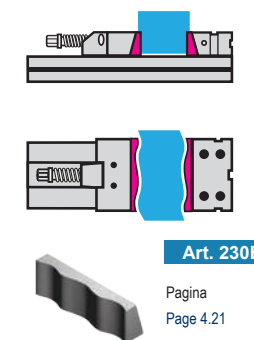
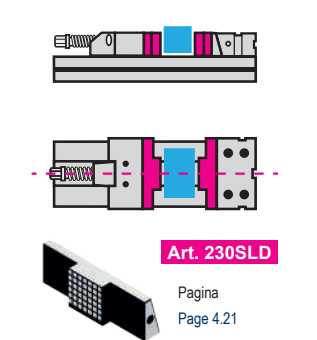

## Soluzioni personalizzate / Customized solutions

# Standard / StdFLEX / XL

### Soluzioni personalizzate a tutti i vostri problemi di serraggio

Customized solutions for all your clamping problems

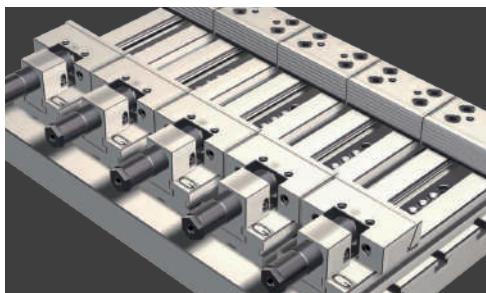

#### Serraggi idraulici

Hydraulic clamping

#### Morse Modulari di Precisione accoppiabili ed allineabili per serraggi multipli idraulici

Precision Modular vises matchable for gang operations and hydraulic clamping

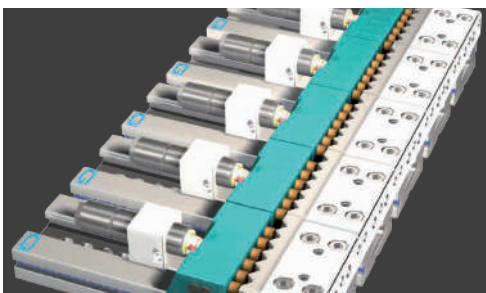

#### Serraggi multipli

Multiple clamping

#### Morse Modulari di Precisione accoppiabili ed allineabili per serraggi multipli idraulici con ganasce speciali oleodinamiche interfacciate a piastre ganasce con inserti prismatici

Matchable and alignable precision modular vises for multiple hydraulic clamping through special hydraulic jaws interfaced to prismatic inserts jaw plates.

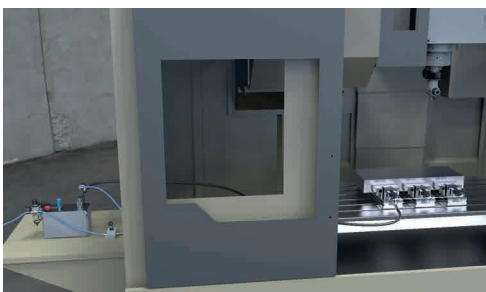

#### Morse StandardMatic

StandardMatic vises

#### Morse StandardMatic montate in serie su centro di lavoro verticale

StandardMatic vises series mounted on vertical machining centres

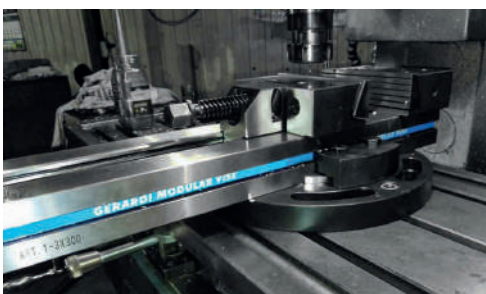

#### Art.2

Art.2

#### Morse Standard Art.1 montate con base girevole graduata su centro di lavoro verticale, per una maggiore versatilità su 360°

Standard vise Art.1 mounted with graduated swivel base on vertical machining centre for a greatest versatility 360°

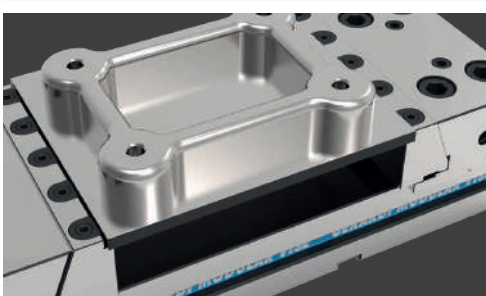

#### Ganasce con inserti Grip

Insert Grip jaw plate

#### Morsa Standard con piastre ganasce a gradino con inserti Grip per un serraggio più efficace

Standard vise equipped with insert grip step jaw plate for more effective workpiece clamping

# VALIGETTA DI CAMPIONATURA STD / StdFLEX

## SAMPLE KIT CASE STD / StdFLEX

### Art. 981



#### Morsa / Vise Art. 1

Cod. 0.98.10000

#### Art. 1 - All'Interno - Inside:

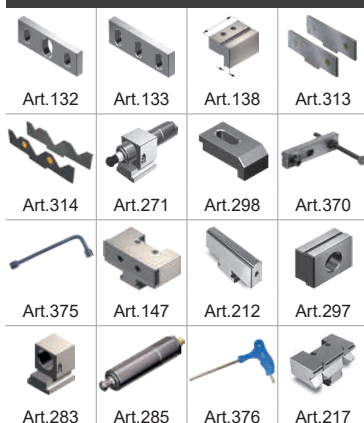

### Art. 985



#### Morsa / Vise Art. 1A

Cod. 0.98.50000

#### Art. 1 - All'Interno - Inside:



## SIMBOLOGIA DATI TECNICI

## TECHNICAL DATA ICONS

<b>GANASCE</b> <b>JAWS</b>							<b>POSSIBILITÀ</b> <b>POSSIBILITY</b>					
	Fissa Fixed	Mobile Movable	Intermedia Intermediate	Fissa con piastra singola Fixed with single plate	Fissa con piastra doppia Fixed with double plate	Ganasce sovrapponibili Stack Type Jaws		Montaggio sul fianco o in serie Side mounting or gang operation	Predisposizione Zero Point Zero Point ready	Cubi-morsa Vise tower	Divisore Automatico Automatic dividing head	Divisore Meccanico Mechanical dividing head
<b>PIASTRE</b> <b>GANASCE</b> <b>JAW PLATES</b>							<b>PAGINE</b> <b>PAGES</b>					
		Discendente Pull down	Piana Straight	Cambio rapido manuale Quick manual change	GRIP integrale integral GRIP	Inseri GRIP GRIP Inserts		Accessori & Ricambi Accessories & Spare Parts	Istruzioni corretto utilizzo Instruction for a proper use	Diagrammi forze di serraggio Clamping force diagrams	Sistema Idraulico Hydraulic System	

## OPZIONI LAVORAZIONI EXTRA

## OPTIONS FOR EXTRA MACHINING

Nei codici, **STD** si riferisce agli articoli dei gruppi 1, 2 e 3.  
 In codes, **STD** refers to articles in groups 1, 2 and 3.

Lavorazione extra Extra machining	Cod.	Lavorazione extra Extra machining	Cod.
AGGIUNTA di un foro calibrato ADDITION of a calibrated hole	MAN-010-STD	MONTAGGIO SEMPLICE SIMPLE ASSEMBLY	MAN-060-STD
AGGIUNTA di una chiave calibrata ADDITION of a calibrated key-way	MAN-020-STD	MONTAGGIO ed ALLINEAMENTO (Standard) (Standard) ASSEMBLY and ALIGNMENT	MAN-070-STD
PREDISPOSIZIONE SEMPLICE SIMPLE SET UP	MAN-030-STD	MONTAGGIO VERTICALE COMPLETE VERTICAL ASSEMBLY	MAN-080-STD
PREDISPOSIZIONE & MONTAGGIO COMPLETO COMPLETE SET UP & MOUNTING	MAN-040-STD	ALLINEAMENTO e CONTROLLO tramite DEA ALIGNMENT and CONTROL by DEA \ CMM	MAN-090-STD
MONTAGGIO PARZIALE PARTIAL ASSEMBLY	MAN-050-STD	TABULATO controllo DEA PRINTOUT DEA control	MAN-100-STD