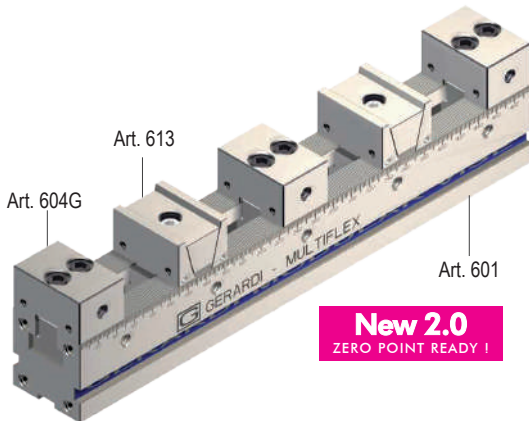

Tipo (grandezza) morsa / Vise type (size)
Art.611

 Morsa con ganasce doppie (Art. 613)
 Vise with double clamping jaws (Art. 613)

 Per particolari in appoggio oppure sollevati con parallele
 For workpieces on vise base or rised up with parallels

kN	1				
	20 kN				
A	4 x 21mm	4 x 46	4 x 71	4 x 94	4 x 121
B	25				
C $0_{-0,02}$	50				
D $0_{-0,05}$	300	400	500	600	700
G $0_{-0,02}$	50				
J	38				
J1	44 / 50				
I	10				
F	15				
W	49				
ØP	9				
Q $\pm 0,02$	100 / 200	100 / 200	200	300	400
kg	6,6	8,1	9,5	11	12,5
Cod.	6.61.11300	6.61.11400	6.61.11500	6.61.11600	6.61.11700

AMPLIA LE TUE APPLICAZIONI TRAMITE GLI ACCESSORI MODULARI !
Art. 604G*

 Ganasca fissa liscia da entrambi i lati
 Fixed smooth jaws both sides

Cod. 6.60.4G100

* Arresto laterale a richiesta - Workstop on request

Art. 610B

Piastra ganasca lavorabile / Soft jaw plate

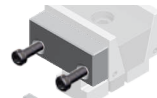

Cod. Art. 610B 6.61.0B100

Art. 610C

Piastra ganasca liscia / Smooth jaw plate



Cod. Art. 610C 6.61.0C100

Art. 610D

Piastra ganasca zigrinata / Serrated jaw plate



Cod. Art. 610D 6.61.0D100

Art. 610E

Piastra ganasca parallela / Parallel jaw plate



Cod. Art. 610E 6.61.0E100

Art. 610F

Piastra ganasca prismatica / Prismatic jaw plate



Cod. Art. 610F 6.61.0F100

Piastrine Art.610B - 610C - 610D - 610E - 610F dimensioni come pagina 6.36 - Jaw plates Art.610B - 610C - 610E - 610F dimensions as page 6.36

Art. 613

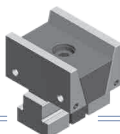
 Ganasca mobile doppia di spinta
 Double clamping movable jaws

Cod. 6.61.31000

Art. 611

Dotazione standard:

- 4 arresti laterali Art. 370
- 1 coppia di tasselli di posizionamento per cava da 16 mm Art. 297
- 1 chiave a T Art. 376

Extra charge for each hole for Zero Point - MAN-010-FMS

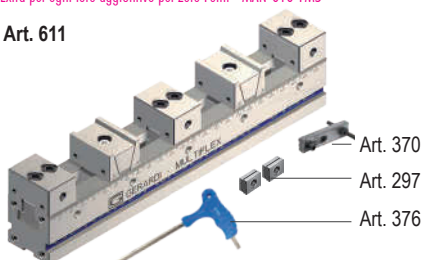
Art. 611

Standard equipment:

- 4 workstops Art. 370
- 1 pair of positioning key-nuts for 16 mm slot Art. 297
- 1 T-wrench Art. 376

Extra charge for each hole for Zero Point - MAN-010-FMS

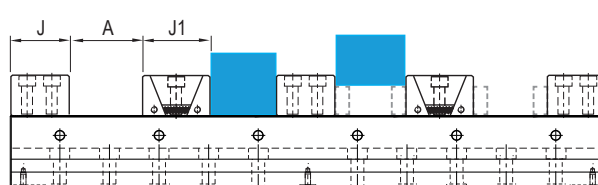
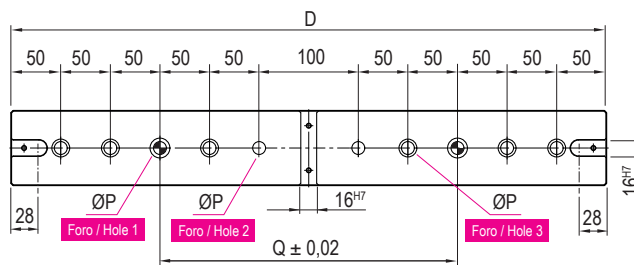

Fori per Zero Point Holes for Zero Point	Foro - Hole 1
Fori per fissaggio morsa Holes for vise clamping	Foro - Hole 2
	Foro - Hole 3

Vedi Pag - See Page 6.30



	2 30 kN						3 40 kN			
A	4 x 34	4 x 59	4 x 84	4 x 109	4 x 134	4x159	4 x 77	4 x 102	4 x 127	4 x 152
B	40						60			
C ⁰ _{-0,02}	75						100			
D ⁰ _{-0,05}	400	500	600	700	800	900	700	800	900	1000
G ⁰ _{-0,02}	75						100			
J	50						70			
J1	52 / 58						84 / 90			
I	11						12			
F	20						20			
W	74						99			
ØP	13						17			
Q ^{±0,02}	200 / 300	200	300	400	400 / 500	300 / 400 / 500	400	400 / 500	400 / 500	400 / 500
kg	20,79	24,29	27,79	31,29	34,8	38,3	63	68,5	74	79,5
Cod. Art. 606	6.61.12400	6.61.12500	6.61.12600	6.61.12700	6.61.12800	6.61.12900	6.61.13700	6.61.13800	6.61.13900	6.61.13100

UPGRADE YOUR VISE APPLICATIONS THROUGH MODULAR ACCESSORIES !

Cod.	6.60.4G200	6.60.4G300
------	------------	------------

Cod. Art. 610B	6.61.0B200	6.61.0B300
Cod. Art. 610C	6.61.0C200	6.61.0C300
Cod. Art. 610D	6.61.0D200	6.61.0D300
Cod. Art. 610E	6.61.0E200	6.61.0E300
Cod. Art. 610F	6.61.0F200	6.61.0F300

Piastrine Art.610B - 610C - 610D - 610E - 610F dimensioni come pagina 6.36 - Jaw plates Art.610B - 610C - 610E - 610F dimensions as page 6.36

Cod.	6.61.32000	6.61.33000
------	------------	------------

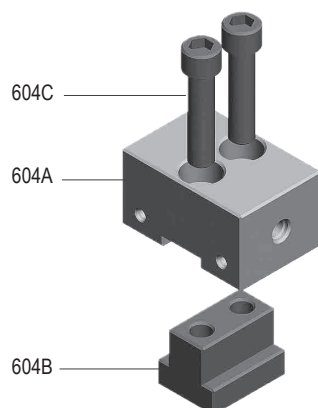
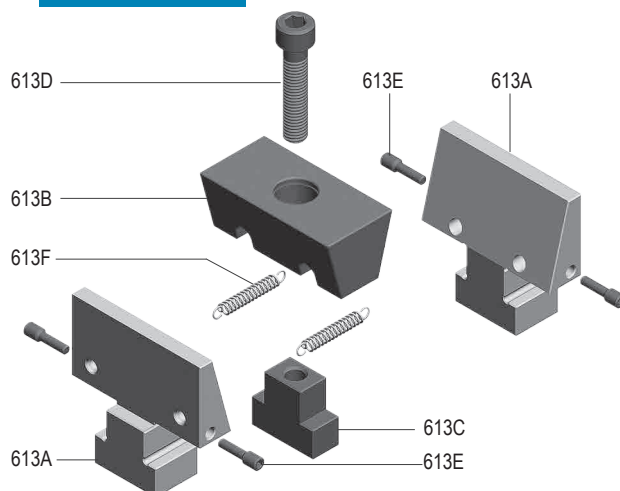
Art. 604G
**GANASCIA FISSA
FIXED JAW**

Art. 613
**GANASCIA DOPPIA
DOUBLE JAW**

Art.	Pag.
601	6.30
604A	6.35
604B	6.35
604C	6.35
604G	6.32
613	6.34
613A	6.37
613B	6.37
613C	6.37
613D	6.37
613E	6.37
613F	6.37

GUIDA RAPIDA

Per la scelta della morsa Multiflex più adatta alle vostre esigenze

Tipo (grandezza) morsa / Vise type (size)

Art. 600

Art. 600W

Art. 600S

 Ogni morsa è completa di
 1 ganaschia fissa,
 4 ganasce fisse-mobili

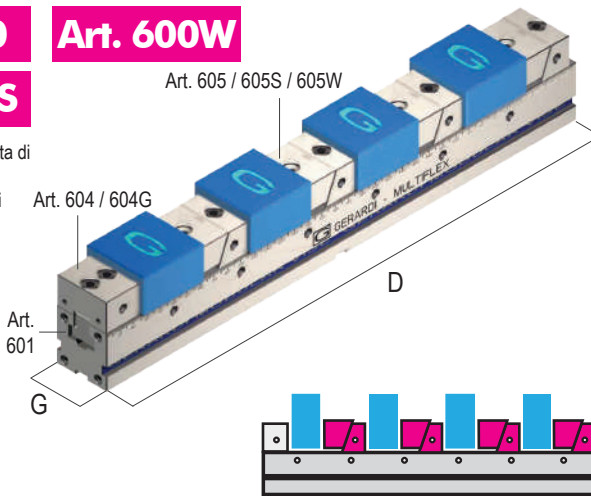
 Each vise is
 supplied with
 1 fixed jaw and
 4 fixed-movable
 jaws

 Per particolari in appoggio sulla base
 For workpieces clamped directly on vise base

 Apertura max in relazione al numero dei particolari
 Max opening according to workpieces to be clamped

kN	1		
	20 kN		
D	300	400	500
G ^{-0,02}	50	50	50
1 pezzo / piece	205	305	408
2 pezzi / pieces	75	125	175
3 pezzi / pieces	30	64	96
4 pezzi / pieces	8	33	58
5 pezzi / pieces	-	15	35
6 pezzi / pieces	-	3	19
7 pezzi / pieces	-	-	8
8 pezzi / pieces	-	-	-
9 pezzi / pieces	-	-	-
10 pezzi / pieces	-	-	-
11 pezzi / pieces	-	-	-
12 pezzi / pieces	-	-	-
Cod. Art. 600	6.60.01300	6.60.01400	6.60.01500
Cod. Art. 600S	6.60.0S130	6.60.0S140	6.60.0S150
Cod. Art. 600W	6.60.0W130	6.60.0W140	6.60.0W150

Art. 606

Art. 606T

 Ogni morsa è completa di
 1 ganaschia fissa,
 4 ganasce fisse-mobili

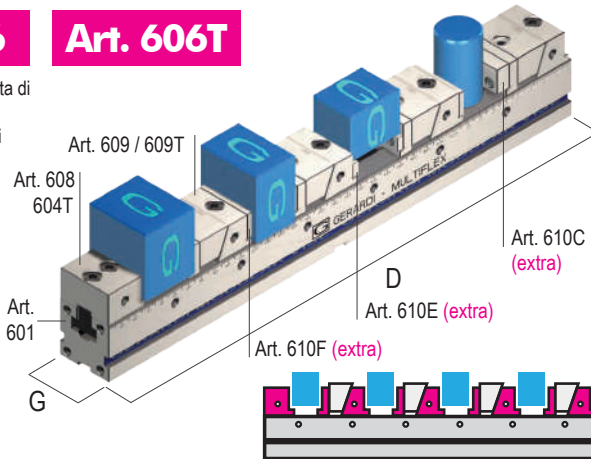
 Each vise is
 supplied with
 1 fixed jaw and
 4 fixed-movable
 jaws

 Per particolari sollevati per forature passanti
 Rised workpieces for drill through holes

 Apertura max in relazione al numero dei particolari
 Max opening according to workpieces to be clamped

D	300 *	400	500
	G ^{-0,02}		
G ^{-0,02}	50	50	50
1 pezzo / piece	193	293	393
2 pezzi / pieces	63	113	163
3 pezzi / pieces	19	53	86
4 pezzi / pieces	-	23	48
5 pezzi / pieces	-	-	25
6 pezzi / pieces	-	-	-
7 pezzi / pieces	-	-	-
8 pezzi / pieces	-	-	-
9 pezzi / pieces	-	-	-
10 pezzi / pieces	-	-	-
11 pezzi / pieces	-	-	-
12 pezzi / pieces	-	-	-
Cod. Art. 606	6.60.61300	6.60.61400	6.60.61500
Cod. Art. 606T	6.60.6T130	6.60.6T140	6.60.6T150

* Solo per tipo 1 x 300 e 2 x 400 n. 3 ganasce fisse-mobili in dotazione Standaard

Art. 611

 Ogni morsa è completa di
 3 ganasce fisse,
 2 ganasce mobili di spinta

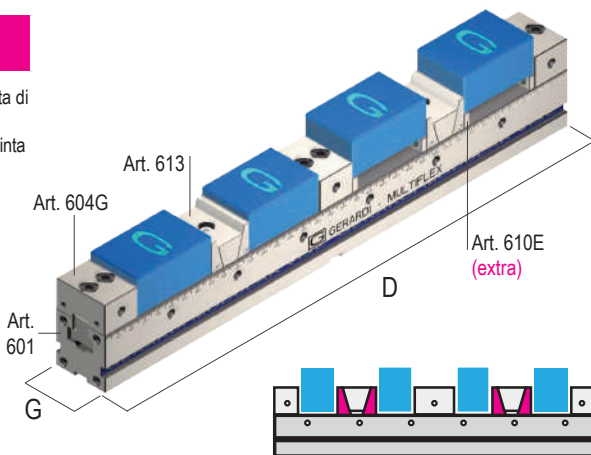
 Each vise is
 supplied with
 3 fixed jaws
 and 2 clamping
 movable jaws

 Per particolari in appoggio oppure sollevati con parallele
 For workpieces on vise base or rised up with parallels

 Apertura max in relazione al numero dei particolari
 Max opening according to workpieces to be clamped

D	300	400	500
	G ^{-0,02}		
G ^{-0,02}	50	50	50
1 pezzo / piece	174	274	374
2 pezzi / pieces	87	137	185
3 pezzi / pieces	28	62	95
4 pezzi / pieces	21	46	71
5 pezzi / pieces	-	19	39
6 pezzi / pieces	-	16	33
7 pezzi / pieces	-	-	15
8 pezzi / pieces	-	-	13
9 pezzi / pieces	-	-	2
10 pezzi / pieces	-	-	-
11 pezzi / pieces	-	-	-
12 pezzi / pieces	-	-	-
Cod.	6.61.11300	6.61.11400	6.61.11500

QUICK GUIDE

For the proper Multiflex vise choice according to your specific application

	1 20 kN		2 30 kN						3 40 kN			
D	600	700	400	500	600	700	800	900	700	800	900	1000
G _{-0,02}	50	50	75	75	75	75	75	75	100	100	100	100
1 pcs.	508	608	275	375	475	575	675	755	532	632	732	832
2 pcs.	225	275	100	150	200	250	300	350	217	267	317	367
3 pcs.	129	161	41	75	108	141	175	280	112	145	178	211
4 pcs.	83	108	12	37	62	87	112	137,5	59	84	109	134
5 pcs.	55	75	-	15	35	55	75	95	28	48	68	88
6 pcs.	36	52	-	-	16	33	50	66,5	7	23	39	55
7 pcs.	22	36	-	-	3	17	32	46	-	6	2	34
8 pcs.	12	24	-	-	-	6	18	31	-	-	5	18
9 pcs.	5	16	-	-	-	-	8	19	-	-	-	5
10 pcs.	-	8	-	-	-	-	-	10	-	-	-	-
11 pcs.	-	2	-	-	-	-	-	2	-	-	-	-
12 pcs.	-	-	-	-	-	-	-	-	-	-	-	-
Cod. Art.	6.60.01600	6.60.01700	6.60.02400	6.60.02500	6.60.02600	6.60.02700	6.60.02800	6.60.02900	6.60.03700	6.60.03800	6.60.03900	6.60.03100
Cod. Art.	6.60.0S160	6.60.0S170	6.60.0S240	6.60.0S250	6.60.0S260	6.60.0S270	6.60.0S280	6.60.0S290	6.60.0S370	6.60.0S380	6.60.0S390	6.60.0S310
Cod. Art.	6.60.0W160	6.60.0W170	6.60.0W240	6.60.0W250	6.60.0W260	6.60.0W270	6.60.0W280	6.60.0W290	6.60.0W370	6.60.0W380	6.60.0W390	6.60.0W310

D	600	700	400 *	500	600	700	800	900	700	800	900	1000
G _{-0,02}	50	50	75	75	75	75	75	75	100	100	100	100
1 pcs.	493	593	262	362	462	562	662	762	512	612	712	812
2 pcs.	213	263	87	137	187	237	287	337	197	247	294	347
3 pcs.	119	152	28	62	95	128	162	195	92	125	158	191
4 pcs.	73	97	-	4 x 27	4 x 52	4 x 77	4 x 102	4 x 127	39	64	89	114
5 pcs.	45	64	-	2	22	42	62	82	8	28	48	68
6 pcs.	26	42	-	-	3	20	37	53,5	-	3	20	37
7 pcs.	13	26	-	-	-	4	19	33	-	-	-	14
8 pcs.	-	14	-	-	-	-	5	18	-	-	-	-
9 pcs.	-	5	-	-	-	-	-	6	-	-	-	-
10 pcs.	-	-	-	-	-	-	-	-	-	-	-	-
11 pcs.	-	-	-	-	-	-	-	-	-	-	-	-
12 pcs.	-	-	-	-	-	-	-	-	-	-	-	-
Cod. Art.	6.60.61600	6.60.61700	6.60.62400	6.60.62500	6.60.62600	6.60.62700	6.60.62800	6.60.62900	6.60.63700	6.60.63800	6.60.63900	6.60.63100
Cod. Art.	6.60.6T160	6.60.6T170	6.60.6T240	6.60.6T250	6.60.6T260	6.60.6T270	6.60.6T280	6.60.6T290	6.60.6T370	6.60.6T380	6.60.6T390	6.60.6T310

* Only for type 1 x 300 and 2 x 400 n. 3 fixed-movable jaws Included in the standard equipment

D	600	700	400	500	600	700	800	900	700	800	900	1000
G _{-0,02}	50	50	75	75	75	75	75	75	100	100	100	100
1 pcs.	474	574	242	342	442	542	642	792	470	570	670	770
2 pcs.	237	287	121	171	221	271	321	371	235	285	335	285
3 pcs.	128	162	45	78	112	145	178	228	103	136	169	202
4 pcs.	96	121	34	59	84	109	134	158,5	77	102	127	152
5 pcs.	59	79	5	25	45	65	85	115	30	50	70	90
6 pcs.	49	66	-	21	38	54	71	87,5	25	41	57	73
7 pcs.	30	44	-	3	17	31	46	66,5	-	12	26	40
8 pcs.	26	38	-	-	15	27	40	52	-	11	23	35
9 pcs.	13	24	-	-	1	12	23	40	-	-	3	14
10 pcs.	12	22	-	-	-	11	21	31	-	-	-	-
11 pcs.	3	12	-	-	-	-	10	22,5	-	-	-	-
12 pcs.	2	11	-	-	-	-	9	16,5	-	-	-	-
Cod. Art.	6.61.11600	6.61.11700	6.61.12400	6.61.12500	6.61.12600	6.61.12700	6.61.12800	6.61.12900	6.61.13700	6.61.13800	6.61.13900	6.61.13100

Morse e cubi morsa / Vises & vise-towers

MULTIFLEX SERIES



Precisione / Accuracy
 $\pm 0,02\text{mm}$



Durezza / Hardened
HRC 58 \pm 2

Per serraggi multipli fino a 19 particolari di varie dimensioni

For flexible clamping of multiple workpieces of various sizes

USURA INESISTENTE / NO WEAR

Grazie all'accurata scelta dei materiali impiegati ed allo studio dimensionale computerizzato dei componenti. Costruzione in speciali lega di acciaio ad alta resistenza, normalizzato, cementato e temprato con durezza fino a 60 HRC. Tutto ciò al fine di conferire massima rigidità, elevate prestazioni e usura inesistente. A riprova di tutto ciò assicuriamo **5 ANNI DI GARANZIA** su tutto il programma morse e organi meccanici in genere.

Thanks to the manufacturing with only the most suitable materials and to the structure of the vise components (developed using computer customised softwares and the experience gained during many years spent working on the specific field). High alloyed quality resistance steel, case hardened up to 60 HRC, is used in manufacturing all the Gerardi vises and accessories in order to give maximum rigidity, high performances and no wear. As evidence we give **5 YEARS WARRANTY** on all the vises and mechanical components.

SERRAGGI ILLIMITATI / UNLIMITED CLAMPING

(Ganasce a gradino, zigrinate, lisce, per tondi, dolci, doppie, ecc.) La posizione, il numero o il tipo di ganasce può variare a seconda delle necessità di serraggio (possibilità di bloccare da 1 a 19 pezzi sulla stessa morse) Pag.6.21

(Step jaws, serrated, flat, prismatic, soft, double, etc.) The jaws positioning, number or type could vary according to the workholding needs (from 1 to 19 pcs. clamping possibility on the same vise base) Page. 6.21

TEMPI DI ATTREZZAGGIO RIDOTTI

REDUCED SET-UP TIMES

Posizionamenti ed ancoraggi delle ganasce sul corpo base di rapida esecuzione ed in prossimità del particolare da lavorare.

Quick and versatile jaws positioning very close to the workpiece.

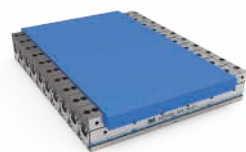

MONTAGGIO IN PARALLELO - PARALLEL MOUNTING

10 morse - Serraggio di 1 particolare
 10 vises - 1 workpiece clamped

10 morse - Serraggio di 4 particolari
 10 vises - 4 workpieces clamped

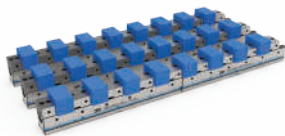
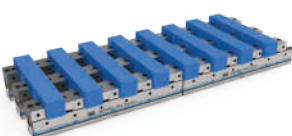

MONTAGGIO IN LINEA - IN LINE MOUNTING

6 morse - Serraggio di 8 particolari
 6 vises - 8 workpieces clamped

6 morse - Serraggio di 24 particolari
 6 vises - 24 workpieces clamped

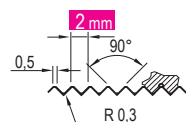

2 mm
 Passo delle righe
 Rows pitch

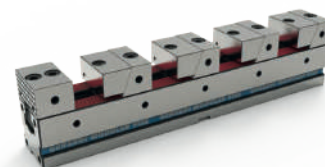

Versatilità - Versatility

Possibilità di posizionare, aggiungere o rimuovere le ganasce su qualsiasi posizione della dentatura della base.

Possibility of jaws positioning, addition or remove on whatever position on the vise base teeth

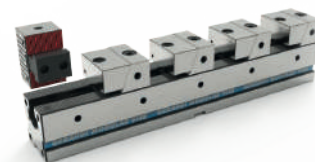

Massima precisione Highest accuracy

Garantita la massima precisione di posizionamento ed allineamento delle ganasce e delle morse grazie alla rettificatura dal pieno della dentatura di ancoraggio della base.

Highest accuracy guaranteed in positioning and alignment ($\pm 0,02\text{ mm}$) thanks to the ground rack teeth on both the base and the fixed jaws.

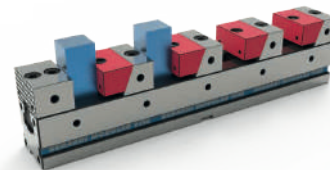

Azione discendente Pull down jaw action

Cuneo di spinta guidato grazie al sistema a pettine con righe rettificata sulla ganasce fissa e mobile.

Wedge clamps with guided pull-down law action thanks to the ground comb-teeth even between the fixed and movable jaws

Le morse della serie MULTIFLEX rappresentano un innovativo sistema modulare di serraggio in grado di sfruttare al massimo la capacità della tavola della macchina e di aumentarne, di conseguenza, la produttività. Il sistema è stato ideato per poter serrare contemporaneamente un notevole numero di pezzi sulla tavola della macchina utensile, riducendo così notevolmente i tempi morti.

The MULTIFLEX series vises are a total new concept of modular clamping system able to maximize the machine table capacity and thus to increase its productivity. This system is designated for clamping several workpieces at the same time on the machine tool table, thus reducing tool changeover times.

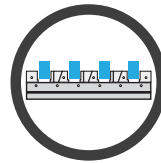

SCAN IT TO SEE



THE WEB PAGE



Le morse più versatili!
The most versatile vises!

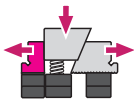

Ganascia fissa e mobile
 con gradino per il sollevamento del particolare
 Fixed & Movable Jaw
 with step to rise up the workpiece

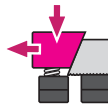

Ganascia fissa e mobile
 per particolari in appoggio sulla base
 Fixed & Movable Jaw
 with step to rise up the workpiece

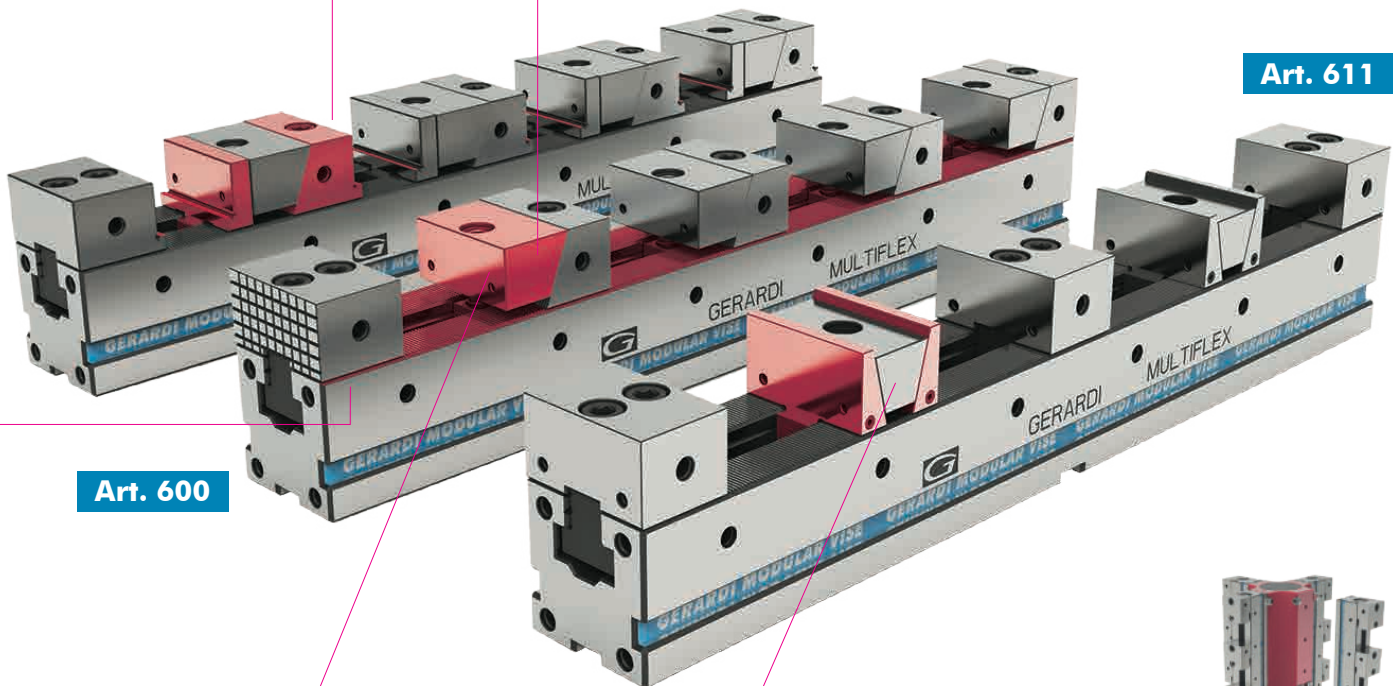
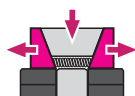
Art. 606
Art. 611

Art. 600

Cuneo di spinta
 Per il serraggio simultaneo di 2 particolari
 Clamping Wedge
 To the clamp of 2 workpieces simultaneously

Montaggio Verticale Vertical Set-Up



Tramite distanziali, strutture portapezzi o cubi-morsa verticali. Le morse modulari MULTIFLEX possono essere assemblate verticalmente, legate fra loro o montate su specifiche strutture portapezzi.

Through spacers, tombstones or vise-towers. MULTIFLEX vises can be vertically assembled linked each other or clamped to specific workholding structures.

Staffe d'ancoraggio / Vise holding clamps

NEW
2024

MULTIFLEX

Coppia staffe di fissaggio Art.296, complete di vite e dado a "T"
Pair of vise holding clamps Art.296 complete of screw and "T" nuts

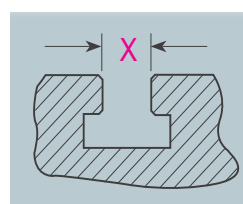
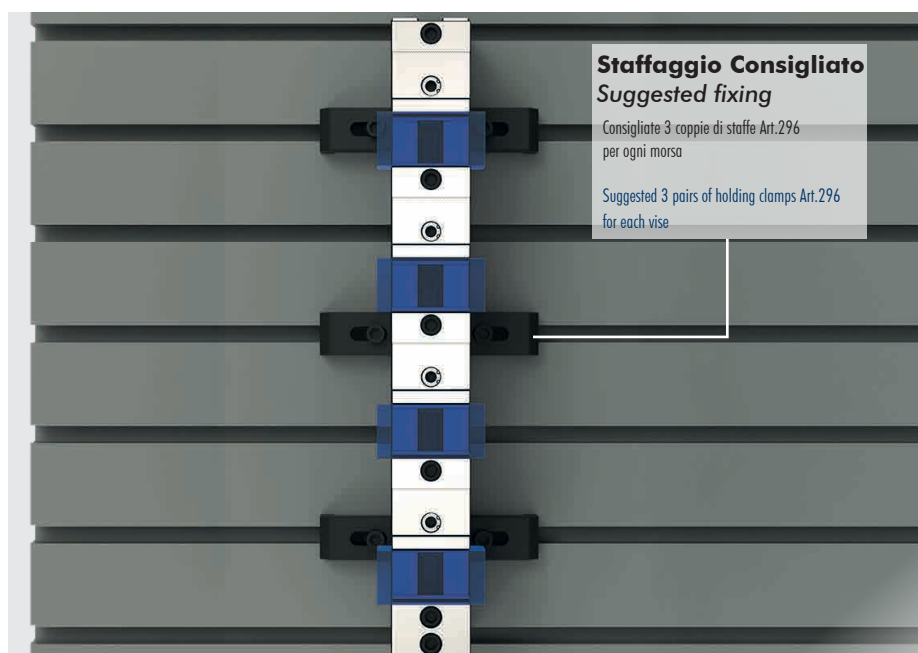
Esempio d'ordine per morsa tipo 3 su macchina con cave a T da 18mm: Art.296 T.3 X=18mm
Oppure con codice: 2.29.6200 X=18mm
Order example for Type 3 vise on machine with 18mm T-slots: Art.296 T.3 X=18mm
Also with code: 2.29.6200 X=18mm

Cava a T
T Slot

Specificare sempre la cava della vostra macchina

Always specify the machine T-slot dimension

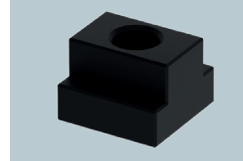
Ref N° Pag.4.34

Art.287
Dadi a T - T Nuts

Per fissaggio morse alle cave a T della macchina

For vise clamping on the machine T-slots

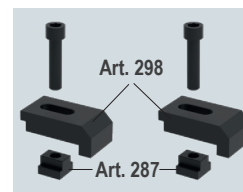
Art.296
(Art.298 + Art.287)

Consigliate 3 coppie di staffe Art.296 per ogni morsa

Suggested 3 pairs of holding clamps Art.296 for each vise

Tipo (grandezza) Type (size)	1				1								2 - 3								
Art. 296	Cava a T slot X	12	14	16	18	12*	14	16	16	18	20	18*	20	22	16	18	20	22	18*	20	22
	T-nuts Ref. N°	8	9	10	11	12	13	14	20	21	22	32	33	34	20	21	33	34	32	33	34
Coppia di staffe Holding clamps pair	Filetto vite Screw thread	M8				M10		M12 *		M16		M12			M16 *						
1 X M8 	A	50				50		50		50		76			76						
	B	24				24		24		24		30			30						
	C	6				6		6		6		6			6						
	Ø D	8,5				11		13		17		13			17						
	E	10				10		10		10		13			13						
	Ø F	14				-		-		-		-			-						
	G / G1	14				16/15		17,5/13		19/9		17/22			16/15						
	H	34				34		34		34		42			42						
	I	8				10		10		10		-			-						
	J	4				4		4		4		10			10						
T ± 0,1	15				15		15		15		20			20							
	Cod.	2.29.61000 / M8				2.29.61000 / M10		2.29.61000 / M12		2.29.61000 / M16		2.29.63000 / M12			2.29.63000 / M12						

* Scelta consigliata - Suggested choice

* Scelta NON consigliata - NOT Suggested choice

Soluzioni personalizzate / Customized solutions

MULTIFLEX

Soluzioni personalizzate a tutti i vostri problemi di serraggio

Customized solutions for all your clamping problems



Morse Multiflex montate verticalmente

Multiflex vises vertically mounted

Cubo portapezzi Art.53C con 8 morse Multiflex Art.606 2x600 montato su Matsura H.Plus 400 per serraggio di 32 pezzi

Tombstone Art.53C with 8 Multiflex vises Art.606 2x600 mounted on Matsura H.Plus 400 for 32 pcs clamping



Morse Multiflex

Multiflex vises

Morse Multiflex montate in parallelo su centro di lavoro verticale per serraggi multipli

Multiflex vises mounted in parallel on vertical machining centre for multiple clamping



Cubo Multiflex

Multiflex vise tower

Particolari fuori dimensione, ma lavorati su cubo Multiflex Art.607 tipo 2

Rather big work-pieces machined on a Multiflex vise tower Art.607 Type 2



Morse Multiflex su quarto asse

Multiflex vises on 4th axis

Morsa Multiflex con relativa piastra di interfaccia montata su quarto asse

Multiflex vise with interface plate assembled on 4th axis



Morse Multiflex

Multiflex vises

Morse Multiflex Art.611 Tipo 1x700mm con ganasce doppie montate su centro di lavoro HAAS per serraggio di 2 particolari, uno fuori dimensione ed uno molto più piccolo

Multiflex vises Art.611 Type 1x700mm with double jaws shown on Haas machining centre for 2 workpieces clamping, one rather big and the other much smaller.

VALIGETTA DI CAMPIONATURA STD (Art.600)

SAMPLE KIT CASE STD (Art.600)

Art. 984

Art.600 T.1x400



Morsa / Vise Art. 600

Cod. 0.98.40000

Art. 600 - All'Interno - Inside:

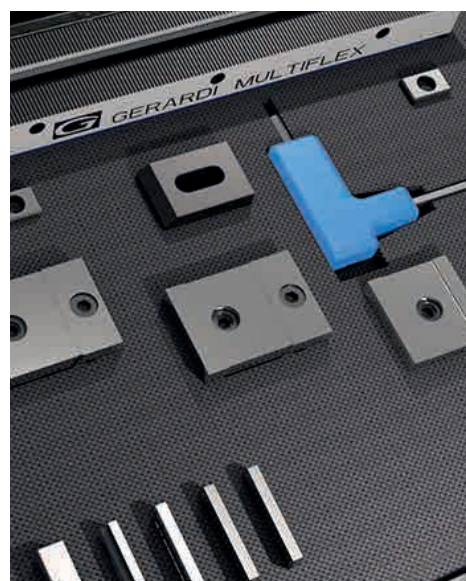
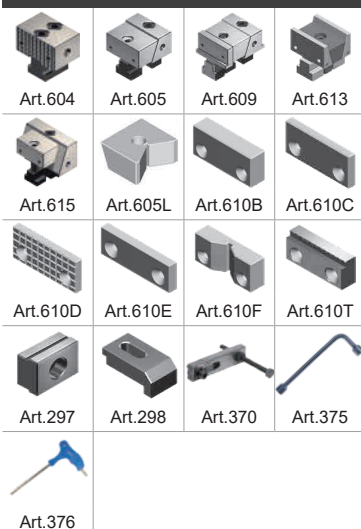

SIMBOLOGIA DATI TECNICI

TECHNICAL DATA ICONS

GANASCE JAWS				
	Fissa Fixed	Mobile e fissa Fixed and movable	Mobile e fissa a gradino Fixed and movable with step	Mobile doppia Double movable
PIASTRE JAW PLATES				
			Piana Straight	GRIP integrale Integral GRIP

POSSIBILITÀ POSSIBILITY				
	Predisposizione Zero Point Zero Point Ready	Cubi-morsa Vise tower	Divisore automatico Dividing head	Divisore Meccanico Mechanical dividing head
PAGINE PAGES				
		Accessori & Ricambi Accessories & Spare Parts	Istruzioni corretto utilizzo Instruction for a proper use	Diagrammi forze di serraggio Clamping force diagrams

OPZIONI LAVORAZIONI EXTRA

OPTIONS FOR EXTRA MACHINING

Nei codici, **FMS** si riferisce agli articoli dei gruppi 5, 6 e 7.
 In codes, **FMS** refers to articles in groups 5, 6 and 7.

Lavorazione extra Extra machining	Cod.
AGGIUNTA di un foro calibrato. ADDITION of a calibrated hole.	MAN-010-FMS
AGGIUNTA di una chiave calibrata. ADDITION of a calibrated key-way.	MAN-020-FMS
PREDISPOSIZIONE SEMPLICE SIMPLE SET UP	MAN-030-FMS
PREDISPOSIZIONE & MONTAGGIO COMPLETO COMPLETE SET UP & MOUNTING	MAN-040-FMS
MONTAGGIO PARZIALE PARTIAL ASSEMBLY	MAN-050-FMS

Lavorazione extra Extra machining	Cod.
MONTAGGIO SEMPLICE SIMPLE ASSEMBLY	MAN-060-FMS
MONTAGGIO ed ALLINEAMENTO (Standard) (Standard) ASSEMBLY and ALIGNMENT	MAN-070-FMS
MONTAGGIO VERTICALE COMPLETE VERTICAL ASSEMBLY	MAN-080-FMS
ALLINEAMENTO e CONTROLLO tramite DEA. ALIGNMENT and CONTROL by DEA \ CMM.	MAN-090-FMS
TABULATO controllo DEA PRINTOUT DEA control	MAN-100-FMS

Vedi pagina 6.44 per esempi applicativi - See page 6.44 for application examples