

**Tipo (grandezza) morsa / Vise type (size)**
**Art. 607**

 Cubo-morsa con ganasce a gradino (Art. 609)  
 Vise-tower with step jaws (Art. 609)

**Art. 607T**

 Cubo-morsa con ganasce **GRIP** (Art. 609T)  
 Vise-tower with **GRIP** jaws (Art. 609T)

 Ogni cubo-morsa è completo di 4 ganasce fisse, 16 ganasce fisse mobili,  
 1 chiave a T, 1 coppia tasselli di posizionamento per cava da 16mm e  
 16 arresti laterali

 Each vise-tower is supplied with 4 fixed jaws and 16 fixed-movable jaws 1  
 T wrench, 1 pair of positioning key-nuts for 16 mm slot Art. 297 and 16  
 workstops

 \* Solo tipo 1x300 e 2x400 n. 12 ganasce fisse-mobili in dotazione  
 Only type 1x300 and 2x400 n. 12 fixed-movable jaws included

Art. 828A extra

**kN**
**1**
**20 kN**

	3 x 19mm *	4 x 23	4 x 48	4 x 73	4 x 97
A					
B			25		
B1			32 / 25		
C <sup>-0</sup> <sub>-0.02</sub>			100		
D	300	400	500	600	700
G <sup>-0</sup> <sub>-0.02</sub>			50		
J			38		
J1			65 / 68		
J2			59 / 62		
H			66		
Ø I <sup>H7</sup>			25		
L			20		
M			14		
W			49		
kg	29,6	34,6	39,6	44,6	49,7
Cod. Art. 607	6.60.71300	6.60.71400	6.60.71500	6.60.71600	6.60.71700
Cod. Art. 607T	6.60.7T130	6.60.7T140	6.60.7T150	6.60.7T160	6.60.7T170

 Per particolari sollevati per forature passanti  
 Rised workpieces for drill through holes

**AMPLIA LE TUE APPLICAZIONI TRAMITE GLI ACCESSORI MODULARI !**
**Art. 609\***

 Ganasca fissa e mobile con gradino  
 Fixed and moving jaw with step

Cod. 6.60.91000

\* Arresto laterale a richiesta - Workstop on request

**Art. 610B**

Piastra ganasca lavorabile / Soft jaw plate



Cod. Art. 610B 6.61.0B100

**Art. 610C**

Piastra ganasca liscia / Smooth jaw plate



Cod. Art. 610C 6.61.0C100

**Art. 610D**

Piastra ganasca zigrinata / Serrated jaw plate



Cod. Art. 610D 6.61.0D100

**Art. 610E**

Piastra ganasca parallela / Parallel jaw plate



Cod. Art. 610E 6.61.0E100

**Art. 610F**

Piastra ganasca prismatica / Prismatic jaw plate



Cod. Art. 610F 6.61.0F100

Piastrine Art.610B - 610C - 610D - 610E - 610F dimensioni come pagina 6.36 - Jaw plates Art.610B - 610C - 610E - 610F dimensions as page 6.36

**Art. 609T\***

 Ganasca fissa e mobile con piastra ganasca  
**GRIP a forte serraggio**

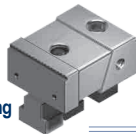
 Fixed and moving jaw with **GRIP** jaw-plates for strongest clamping

Cod. 6.60.9T100

\* Arresto laterale a richiesta - Workstop on request

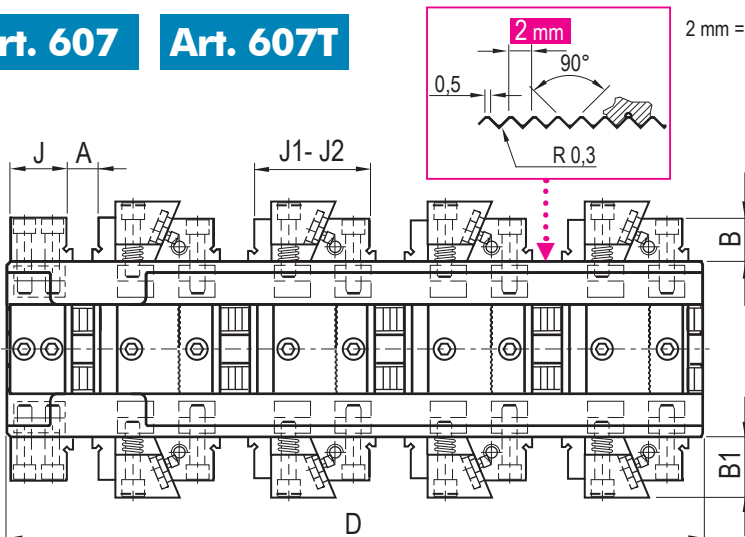
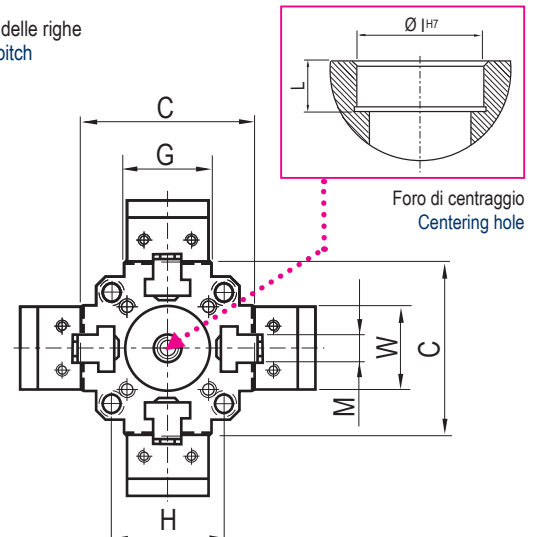
**Art. 607**
**Art. 607T**

 2 mm = Passo delle righe  
 Rows pitch

 Foro di centraggio  
 Centering hole

2 30 kN					3 40 kN							
A	3 x 28mm*	4 x 24	4 x 49	4 x 49	4 x 74	4 x 74	4 x 74	4 x 99	4 x 39	4 x 64	4 x 89	4 x 114
B		40		40	40			40			60	
B1		40		40	40			40			60	
C <sup>-0 -0.02</sup>		150		230	150	210	240				240	
D	400	500	600	600	700	700	700	800	700	800	900	1000
G <sup>-0 -0.02</sup>		75		75	75			75			100	
J		50		50	50			50			70	
J1		83 / 88		83 / 88	83 / 88			83 / 88			109 / 113	
J2		77 / 82		77 / 82	77 / 82			77 / 82			103 / 107	
H		100		-	100	-	-	-			150 / 200	
Ø I <sup>H7</sup>		50		50	50			50			50	
L		20		20	20			20			20	
M		22		22	22			22			30	
W		74		74	74			74			99	
kg	85,6	96,8	108	150	119,2	155,8	183	203	268	292	315	339
Cod. Art.	6.60.72400	6.60.72500	6.60.72600	6.60.72601	6.60.72700	6.60.72701	6.60.72702	6.60.72800	6.60.73700	6.60.73800	6.60.73900	6.60.73100
Cod. Art.	6.60.7T240	6.60.7T250	6.60.7T260	6.60.7T261	6.60.7T270	6.60.7T271	6.60.7T272	6.60.7T280	6.60.7T370	6.60.7T380	6.60.7T390	6.60.7T310

I prezzi su fondo magenta sono **comprensivi di base integrale** / Prices on the magenta background include the solid head plate with the vise-tower

### UPGRADE YOUR VISE APPLICATIONS THROUGH MODULAR ACCESSORIES !

Cod.	6.60.92000	6.60.93000
Cod. Art. 610B	6.61.0B200	6.61.0B300
Cod. Art. 610C	6.61.0C200	6.61.0C300
Cod. Art. 610D	6.61.0D200	6.61.0D300
Cod. Art. 610E	6.61.0E200	6.61.0E300
Cod. Art. 610F	6.61.0F200	6.61.0F300

Piastrine Art.610B - 610C - 610D - 610E - 610F dimensioni come pagina 6.36 - Jaw plates Art.610B - 610C - 610E - 610F dimensions as page 6.36

Cod.	6.60.9T200	6.60.9T300
------	------------	------------

#### Art. 609

Ganascia fissa e mobile con gradino  
Fixed and moving jaw with step

#### Art. 609T

Ganascia fissa e mobile con piastra ganascia **GRIP a forte serraggio**  
Fixed and moving jaw with GRIP jaw-plates for strongest clamping

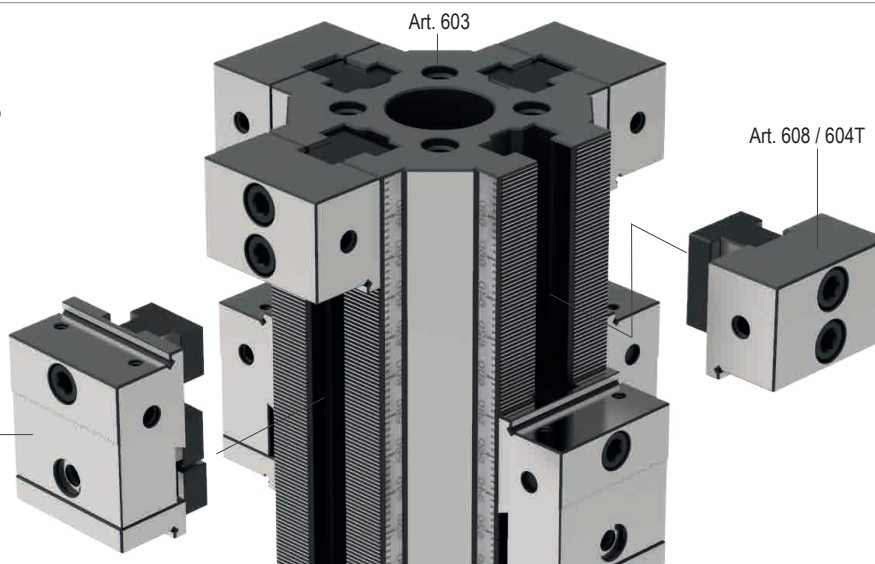

Art.	Pag.
603	6.31
608	6.32
609	6.33

# Morse e cubi morsa / Vises & vise-towers

# MULTIFLEX SERIES



Precisione / Accuracy  
 $\pm 0,02\text{mm}$



Durezza / Hardened  
**HRC 58 $\pm$ 2**

**Per serraggi multipli fino a 19 particolari di varie dimensioni**

*For flexible clamping of multiple workpieces of various sizes*

## USURA INESISTENTE / NO WEAR

Grazie all'accurata scelta dei materiali impiegati ed allo studio dimensionale computerizzato dei componenti. Costruzione in speciali lega di acciaio ad alta resistenza, normalizzato, cementato e temprato con durezza fino a 60 HRC. Tutto ciò al fine di conferire massima rigidità, elevate prestazioni e usura inesistente. A riprova di tutto ciò assicuriamo **5 ANNI DI GARANZIA** su tutto il programma morse e organi meccanici in genere.

Thanks to the manufacturing with only the most suitable materials and to the structure of the vise components (developed using computer customised softwares and the experience gained during many years spent working on the specific field). High alloyed quality resistance steel, case hardened up to 60 HRC, is used in manufacturing all the Gerardi vises and accessories in order to give maximum rigidity, high performances and no wear. As evidence we give **5 YEARS WARRANTY** on all the vises and mechanical components.

## SERRAGGI ILLIMITATI / UNLIMITED CLAMPING

(Ganasce a gradino, zigrinate, lisce, per tondi, dolci, doppie, ecc.) La posizione, il numero o il tipo di ganasce può variare a seconda delle necessità di serraggio (possibilità di bloccare da 1 a 19 pezzi sulla stessa morsa) Pag.6.21

(Step jaws, serrated, flat, prismatic, soft, double, etc.) The jaws positioning, number or type could vary according to the workholding needs (from 1 to 19 pcs. clamping possibility on the same vise base) Page. 6.21

## TEMPI DI ATTREZZAGGIO RIDOTTI

### REDUCED SET-UP TIMES

Posizionamenti ed ancoraggi delle ganasce sul corpo base di rapida esecuzione ed in prossimità del particolare da lavorare.

Quick and versatile jaws positioning very close to the workpiece.



### MONTAGGIO IN PARALLELO - PARALLEL MOUNTING

10 morse - Serraggio di 1 particolare  
 10 vises - 1 workpiece clamped

10 morse - Serraggio di 4 particolari  
 10 vises - 4 workpieces clamped

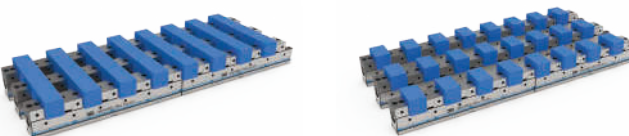

### MONTAGGIO IN LINEA - IN LINE MOUNTING

6 morse - Serraggio di 8 particolari  
 6 vises - 8 workpieces clamped

6 morse - Serraggio di 24 particolari  
 6 vises - 24 workpieces clamped

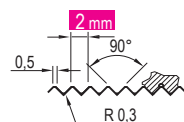

**2 mm**  
 Passo delle righe  
 Rows pitch

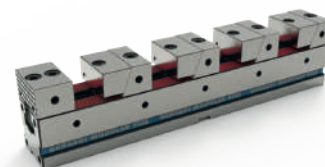

## Versatilità - Versatility

Possibilità di posizionare, aggiungere o rimuovere le ganasce su qualsiasi posizione della dentatura della base.

Possibility of jaws positioning, addition or remove on whatever position on the vise base teeth

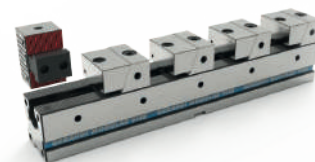

## Massima precisione Highest accuracy

Garantita la massima precisione di posizionamento ed allineamento delle ganasce e delle morse grazie alla rettificatura dal pieno della dentatura di ancoraggio della base.

Highest accuracy guaranteed in positioning and alignment ( $\pm 0,02\text{ mm}$ ) thanks to the ground rack teeth on both the base and the fixed jaws.



## Azione discendente Pull down jaw action

Cuneo di spinta guidato grazie al sistema a pettine con righe rettificata sulla ganasce fissa e mobile.

Wedge clamps with guided pull-down law action thanks to the ground comb-teeth even between the fixed and movable jaws

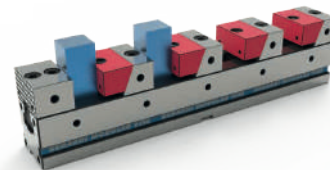

Le morse della serie MULTIFLEX rappresentano un innovativo sistema modulare di serraggio in grado di sfruttare al massimo la capacità della tavola della macchina e di aumentarne, di conseguenza, la produttività. Il sistema è stato ideato per poter serrare contemporaneamente un notevole numero di pezzi sulla tavola della macchina utensile, riducendo così notevolmente i tempi morti.

The MULTIFLEX series vises are a total new concept of modular clamping system able to maximize the machine table capacity and thus to increase its productivity. This system is designated for clamping several workpieces at the same time on the machine tool table, thus reducing tool changeover times.

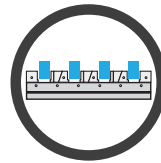

SCAN IT TO SEE



THE WEB PAGE



*Le morse più versatili!*  
*The most versatile vises!*

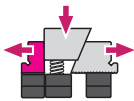

**Ganascia fissa e mobile**  
 con gradino per il sollevamento del particolare  
 Fixed & Movable Jaw  
 with step to rise up the workpiece

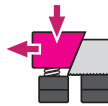

**Ganascia fissa e mobile**  
 per particolari in appoggio sulla base  
 Fixed & Movable Jaw  
 with step to rise up the workpiece

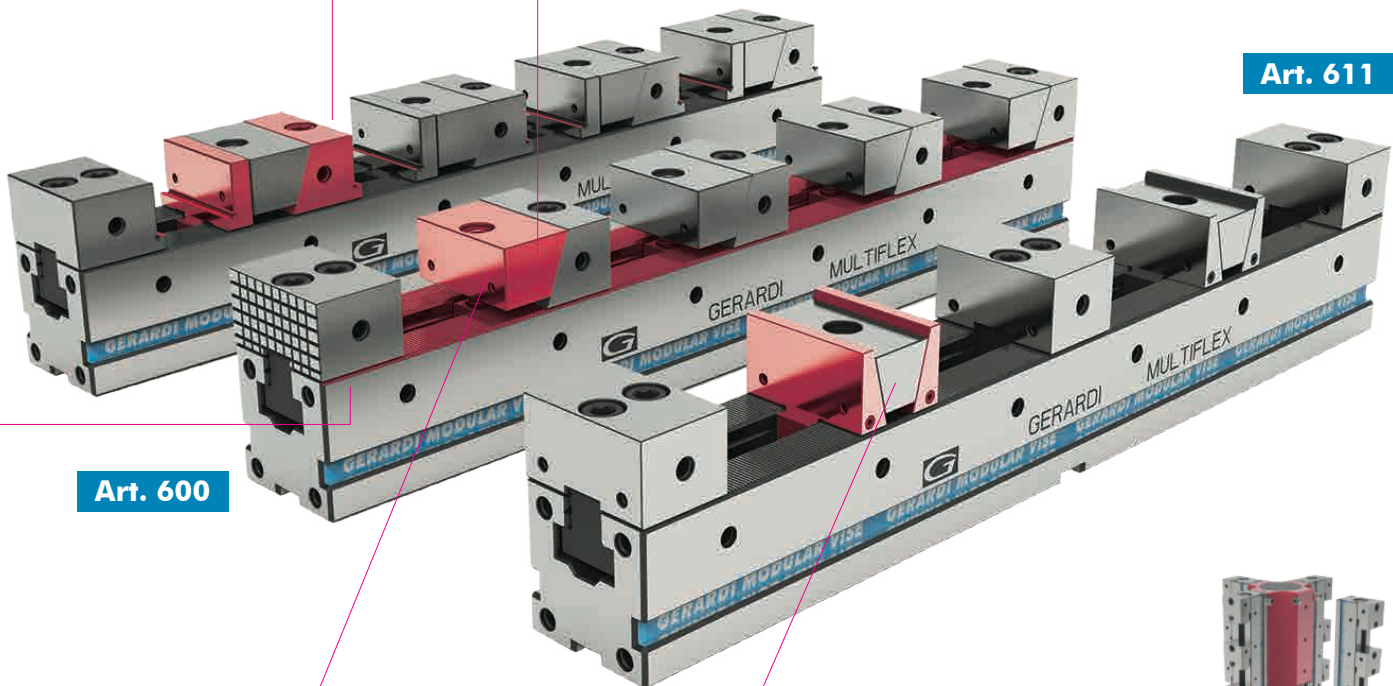
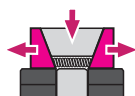
**Art. 606**
**Art. 611**

**Art. 600**

**Cuneo di spinta**  
 Per il serraggio simultaneo di 2 particolari  
 Clamping Wedge  
 To the clamp of 2 workpieces simultaneously

### Montaggio Verticale Vertical Set-Up



Tramite distanziali, strutture portapezzi o cubi-morsa verticali. Le morse modulari MULTIFLEX possono essere assemblate verticalmente, legate fra loro o montate su specifiche strutture portapezzi.

Through spacers, tombstones or vise-towers. MULTIFLEX vises can be vertically assembled linked each other or clamped to specific workholding structures.

# Staffe d'ancoraggio / Vise holding clamps

**NEW**  
**2024**

## MULTIFLEX

**Coppia staffe di fissaggio Art.296, complete di vite e dado a "T"**
*Pair of vise holding clamps Art.296 complete of screw and "T" nuts*

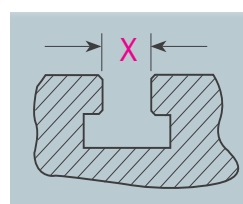
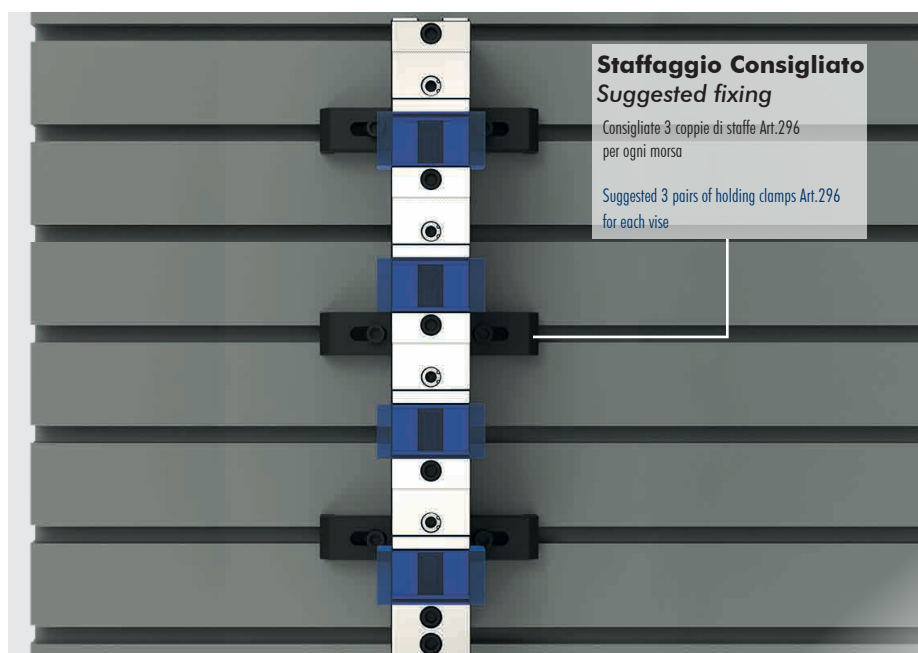
**Esempio d'ordine per morsa tipo 3 su macchina con cave a T da 18mm: Art.296 T.3 X=18mm**
**Oppure con codice: 2.29.6200 X=18mm**
*Order example for Type 3 vise on machine with 18mm T-slots: Art.296 T.3 X=18mm*
*Also with code: 2.29.6200 X=18mm*

**Cava a T**
**T Slot**

Specificare sempre la cava della vostra macchina

Always specify the machine T-slot dimension

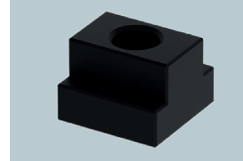
Ref N° Pag.4.34

**Art.287**
**Dadi a T - T Nuts**

Per fissaggio morse alle cave a T della macchina

For vise clamping on the machine T-slots

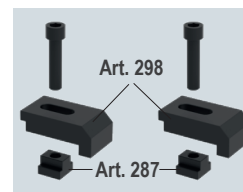
**Art.296**
**(Art.298 + Art.287)**

Consigliate 3 coppie di staffe Art.296 per ogni morsa

Suggested 3 pairs of holding clamps Art.296 for each vise

Tipo (grandezza) Type (size)	1				1								2 - 3								
<b>Art. 296</b>	Cava a T slot X	12	14	16	18	12*	14	16	16	18	20	18*	20	22	16	18	20	22	18*	20	22
	T-nuts Ref. N°	8	9	10	11	12	13	14	20	21	22	32	33	34	20	21	33	34	32	33	34
<b>Coppia di staffe</b> <b>Holding clamps pair</b>	Filetto vite Screw thread	<b>M8</b>				<b>M10</b>		<b>M12 *</b>		<b>M16</b>		<b>M12</b>			<b>M16 *</b>						
<b>1 X M8</b> 	A	50				50		50		50		76			76						
	B	24				24		24		24		30			30						
	C	6				6		6		6		6			6						
	Ø D	8,5				11		13		17		13			17						
	E	10				10		10		10		13			13						
	Ø F	14				-		-		-		-			-						
	G / G1	14				16/15		17,5/13		19/9		17/22			16/15						
	H	34				34		34		34		42			42						
	I	8				10		10		10		-			-						
	J	4				4		4		4		10			10						
T ± 0,1	15				15		15		15		20			20							
	Cod.	2.29.61000 / M8				2.29.61000 / M10		2.29.61000 / M12		2.29.61000 / M16		2.29.63000 / M12			2.29.63000 / M12						

\* Scelta consigliata - Suggested choice

\* Scelta NON consigliata - NOT Suggested choice

## Soluzioni personalizzate / Customized solutions

# MULTIFLEX

### Soluzioni personalizzate a tutti i vostri problemi di serraggio

*Customized solutions for all your clamping problems*



#### **Morse Multiflex montate verticalmente**

*Multiflex vises vertically mounted*

**Cubo portapezzi Art.53C con 8 morse Multiflex Art.606 2x600 montato su Matsura H.Plus 400 per serraggio di 32 pezzi**

Tombstone Art.53C with 8 Multiflex vises Art.606 2x600 mounted on Matsura H.Plus 400 for 32 pcs clamping



#### **Morse Multiflex**

*Multiflex vises*

**Morse Multiflex montate in parallelo su centro di lavoro verticale per serraggi multipli**

Multiflex vises mounted in parallel on vertical machining centre for multiple clamping



#### **Cubo Multiflex**

*Multiflex vise tower*

**Particolari fuori dimensione, ma lavorati su cubo Multiflex Art.607 tipo 2**

Rather big work-pieces machined on a Multiflex vise tower Art.607 Type 2



#### **Morse Multiflex su quarto asse**

*Multiflex vises on 4th axis*

**Morsa Multiflex con relativa piastra di interfaccia montata su quarto asse**

Multiflex vise with interface plate assembled on 4th axis



#### **Morse Multiflex**

*Multiflex vises*

**Morse Multiflex Art.611 Tipo 1x700mm con ganasce doppie montate su centro di lavoro HAAS per serraggio di 2 particolari, uno fuori dimensione ed uno molto più piccolo**

Multiflex vises Art.611 Type 1x700mm with double jaws shown on Haas machining centre for 2 workpieces clamping, one rather big and the other much smaller.

# VALIGETTA DI CAMPIONATURA STD (Art.600)

## SAMPLE KIT CASE STD (Art.600)

### Art. 984

Art.600 T.1x400



### Morsa / Vise Art. 600

Cod. 0.98.40000

### Art. 600 - All'Interno - Inside:

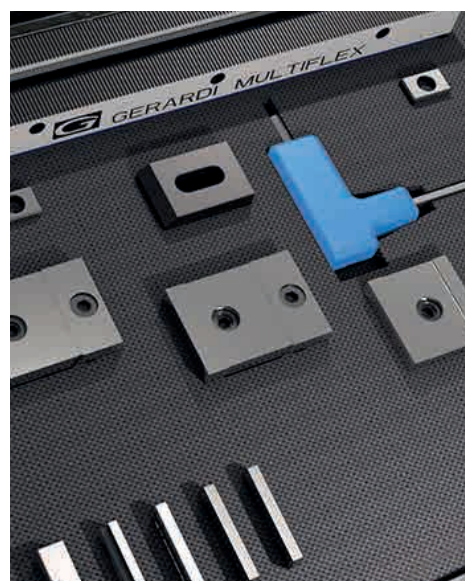
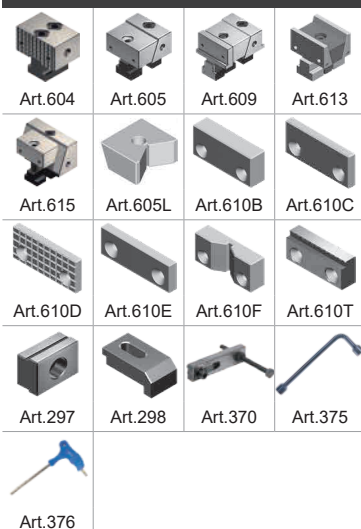

## SIMBOLOGIA DATI TECNICI

## TECHNICAL DATA ICONS

<b>GANASCE</b> JAWS				
	Fissa Fixed	Mobile e fissa Fixed and movable	Mobile e fissa a gradino Fixed and movable with step	Mobile doppia Double movable
<b>PIASTRE</b> GANASCE JAW PLATES				
			Piana Straight	GRIP integrale Integral GRIP

<b>POSSIBILITÀ</b> POSSIBILITY				
	Predisposi- zione Zero Point Zero Point Ready	Cubi-morsa Vise tower	Divisore automatico Dividing head	Divisore Meccanico Mechanical dividing head
<b>PAGINE</b> PAGES				
		Accessori & Ricambi Accessories & Spare Parts	Istruzioni corretto utilizzo Instruction for a proper use	Diagrammi forze di seraggio Clamping force diagrams

## OPZIONI LAVORAZIONI EXTRA

## OPTIONS FOR EXTRA MACHINING

Nei codici, **FMS** si riferisce agli articoli dei gruppi 5, 6 e 7.  
 In codes, **FMS** refers to articles in groups 5, 6 and 7.

Lavorazione extra Extra machining	Cod.
AGGIUNTA di un foro calibrato. ADDITION of a calibrated hole.	MAN-010-FMS
AGGIUNTA di una chiave calibrata. ADDITION of a calibrated key-way.	MAN-020-FMS
PREDISPOSIZIONE SEMPLICE SIMPLE SET UP	MAN-030-FMS
PREDISPOSIZIONE & MONTAGGIO COMPLETO COMPLETE SET UP & MOUNTING	MAN-040-FMS
MONTAGGIO PARZIALE PARTIAL ASSEMBLY	MAN-050-FMS

Lavorazione extra Extra machining	Cod.
MONTAGGIO SEMPLICE SIMPLE ASSEMBLY	MAN-060-FMS
MONTAGGIO ed ALLINEAMENTO (Standard) (Standard) ASSEMBLY and ALIGNMENT	MAN-070-FMS
MONTAGGIO VERTICALE COMPLETE VERTICAL ASSEMBLY	MAN-080-FMS
ALLINEAMENTO e CONTROLLO tramite DEA. ALIGNMENT and CONTROL by DEA \ CMM.	MAN-090-FMS
TABULATO controllo DEA PRINTOUT DEA control	MAN-100-FMS

Vedi pagina 6.44 per esempi applicativi - See page 6.44 for application examples