

Tipo (grandezza) morsa / Vise type (size)
Art. 602

 Cubo-morsa con ganasce lisce (Art. 605)
 Vise-tower with smooth jaws (Art. 605)

Art. 602S

 Cubo-morsa con ganasce zigrinate (Art. 605S)
 Vise-tower with serrated jaws (Art. 605S)

Art. 602W

 Cubo-morsa con ganasce mobili lisce e
 fisse zigrinate (Art. 605W)
 Vise cube with smooth movable jaw and
 fixed serrated jaws (Art. 605W)

 Ogni cubo-morsa è completo di 4 ganasce fisse, 16 ganasce fisse mobili,
 1 chiave a T, 1 coppia tasselli di posizionamento per cava da 16mm e 16
 arresti laterali

 Each vise-tower is supplied with 4 fixed jaws and
 16 fixed-movable jaws, 1 T wrench, 1 pair of
 positioning key-nuts for 16 mm slot Art. 297 and 16 workstops

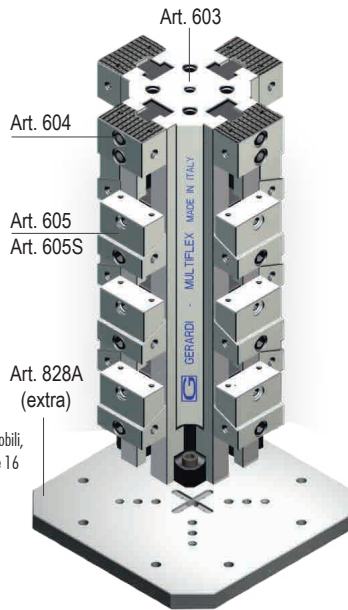
Per particolari in appoggio sulla base
For workpieces clamped directly on vise base

kN	1				
	20 kN				
A	4 x 8mm	4 x 33	4 x 58	4 x 83	4 x 108
B	25				
B1	32 / 25				
C ⁻⁰ _{-0,02}	100				
D	300	400	500	600	700
G ⁻⁰ _{-0,02}	50				
J	38				
J1	55 / 58				
H	66				
Ø I ^{H7}	25				
L	20				
M	14				
kg	26,2	31,2	36,2	41,2	46,3
Cod. Art.602	6.60.21300	6.60.21400	6.60.21500	6.60.21600	6.60.21700
Cod. Art.602S	6.60.2S130	6.60.2S140	6.60.2S150	6.60.2S160	6.60.2S170
Cod. Art.602W	6.60.2W130	6.60.2W140	6.60.2W150	6.60.2W160	6.60.2W170

AMPLIA LE TUE APPLICAZIONI TRAMITE GLI ACCESSORI MODULARI !
Art. 604*

 Ganasca fissa (1 lato liscia, 1 lato zigrinata)
 Fixed jaw (1 side smooth, 1 side serrated)

Cod. 6.60.41000

* Arresto laterale a richiesta - Workstop on request

Art. 605*

 Ganasca mobile
 e fissa liscia
 Fixed and movable
 smooth jaws

Art. 605S*

 Ganasca mobile
 e fissa zigrinata
 Fixed and movable
 serrated jaws

Cod. Art.605 6.60.51000

Cod. Art.605S 6.60.5S100

* Arresto laterale a richiesta - Workstop on request

Art. 605L

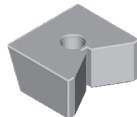
 Cuneo di spinta a "V"
 "V" clamping wedge

Cod. 6.60.5L100

Art. 615*

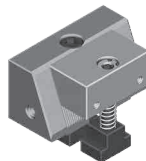
 Ganasca con cuneo di posizionamento maggiorato
 Jaw with bigger positioning wedge
 (increased with respect to standard dimensions)

Cod. 6.61.51000

* Arresto laterale a richiesta - Workstop on request

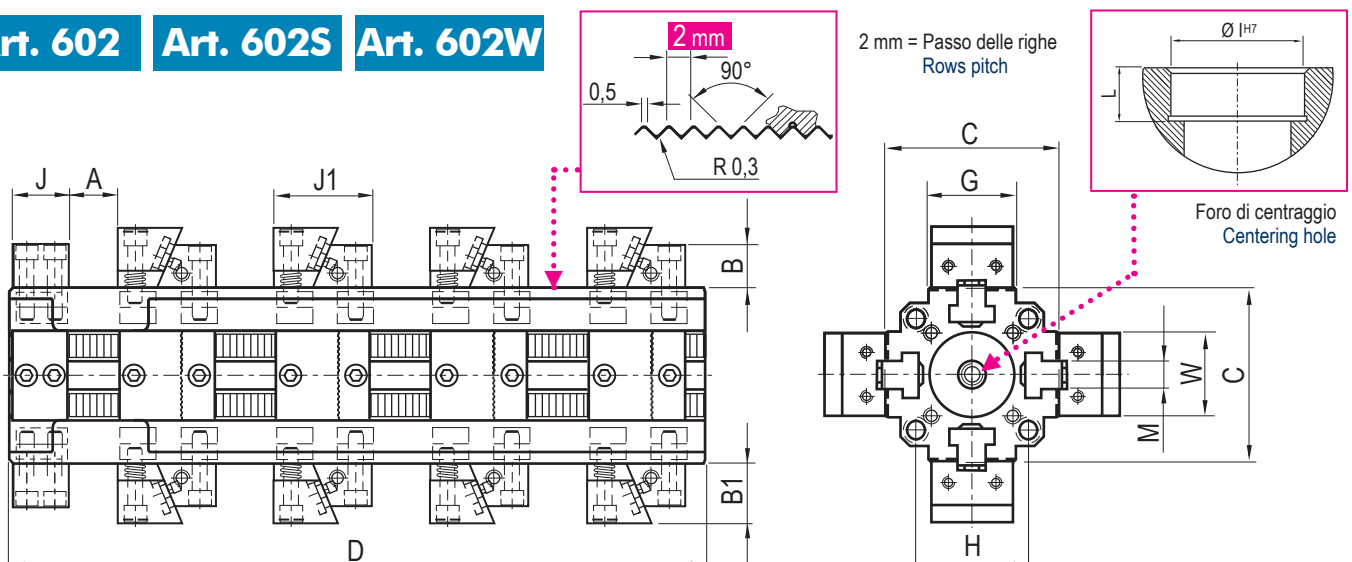
Art. 602 Art. 602S Art. 602W

				2 30 kN					3 40 kN			
A	4 x 12mm	4 x 37	4 x 62	4 x 62	4 x 87	4 x 87	4 x 87	4 x 112	4 x 59	4 x 84	4 x 109	4 x 134
B		40		40	40		40			60		
B1		40		40	40		40			60		
C ⁻⁰ _{-0,02}		150		230	150	210	240			240		
D	400	500	600	600	700	700	700	800	700	800	900	1000
G ⁻⁰ _{-0,02}		75		75	75		75			100		
J		50		50	50		50			70		
J1		70 / 75		70 / 75	70 / 75		70 / 75			94,5 / 98,5		
H		100		-	100	100	-	-		150 / 200		
Ø I ^{H7}		50		50	50		50			50		
L		20		20	20		20			20		
M		22		22	22		22			30		
kg	79	90,2	101,4	144	112,6	149,2	175	195	254	278	301	325
Cod. Art.	6.60.22400	6.60.22500	6.60.22600	6.60.22601	6.60.22700	6.60.22701	6.60.22702	6.60.22800	6.60.23700	6.60.23800	6.60.23900	6.60.23100
Cod. Art.	6.60.2S240	6.60.2S250	6.60.2S260	6.60.2S261	6.60.2S270	6.60.2S271	6.60.2S272	6.60.2S280	6.60.2S370	6.60.2S380	6.60.2S390	6.60.2S310
Cod. Art.	6.60.2W240	6.60.2W250	6.60.2W260	6.60.2W261	6.60.2W270	6.60.2W271	6.60.2W272	6.60.2W280	6.60.2W370	6.60.2W380	6.60.2W390	6.60.2W310

I prezzi su fondo magenta sono **comprensivi di base integrale** / Prices on the magenta background include the solid head plate with the vise-tower

UPGRADE YOUR VISE APPLICATIONS THROUGH MODULAR ACCESSORIES !

6.60.42000

6.60.43000

6.60.52000

6.60.53000

6.60.5S200

6.60.5S300

6.60.5L200

6.60.5L300

6.61.52000

6.61.53000

Art. 605
**GANASCIA LISCIA
JAW PLATE**

Per il serraggio di particolari finiti
To clamp finished workpieces

Art. 605W

Ganascia mobile liscia e fissa zigrinata
Smooth movable jaw and fixed serrated jaw

Art. 605S
**GANASCIA ZIGRINATA
SERRATED JAW**

Per il serraggio di particolari grezzi
To clamp rough workpieces

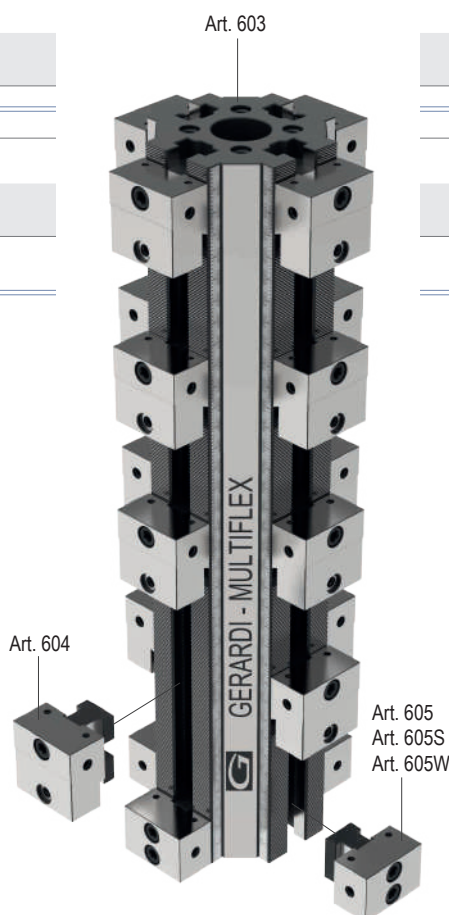

Art.	Pag.
603	6.31
604	6.32
605	6.33
605S	6.33

Morse e cubi morsa / Vises & vise-towers

MULTIFLEX SERIES



Precisione / Accuracy
 $\pm 0,02\text{mm}$



Durezza / Hardened
HRC 58 \pm 2

Per serraggi multipli fino a 19 particolari di varie dimensioni

For flexible clamping of multiple workpieces of various sizes

USURA INESISTENTE / NO WEAR

Grazie all'accurata scelta dei materiali impiegati ed allo studio dimensionale computerizzato dei componenti. Costruzione in speciali lega di acciaio ad alta resistenza, normalizzato, cementato e temprato con durezza fino a 60 HRC. Tutto ciò al fine di conferire massima rigidità, elevate prestazioni e usura inesistente. A riprova di tutto ciò assicuriamo **5 ANNI DI GARANZIA** su tutto il programma morse e organi meccanici in genere.

Thanks to the manufacturing with only the most suitable materials and to the structure of the vise components (developed using computer customised softwares and the experience gained during many years spent working on the specific field). High alloyed quality resistance steel, case hardened up to 60 HRC, is used in manufacturing all the Gerardi vises and accessories in order to give maximum rigidity, high performances and no wear. As evidence we give **5 YEARS WARRANTY** on all the vises and mechanical components.

SERRAGGI ILLIMITATI / UNLIMITED CLAMPING

(Ganasce a gradino, zigrinate, lisce, per tondi, dolci, doppie, ecc.) La posizione, il numero o il tipo di ganasce può variare a seconda delle necessità di serraggio (possibilità di bloccare da 1 a 19 pezzi sulla stessa morse) Pag.6.21

(Step jaws, serrated, flat, prismatic, soft, double, etc.) The jaws positioning, number or type could vary according to the workholding needs (from 1 to 19 pcs. clamping possibility on the same vise base) Page. 6.21

TEMPI DI ATTREZZAGGIO RIDOTTI

REDUCED SET-UP TIMES

Posizionamenti ed ancoraggi delle ganasce sul corpo base di rapida esecuzione ed in prossimità del particolare da lavorare.

Quick and versatile jaws positioning very close to the workpiece.



MONTAGGIO IN PARALLELO - PARALLEL MOUNTING

10 morse - Serraggio di 1 particolare
 10 vises - 1 workpiece clamped

10 morse - Serraggio di 4 particolari
 10 vises - 4 workpieces clamped

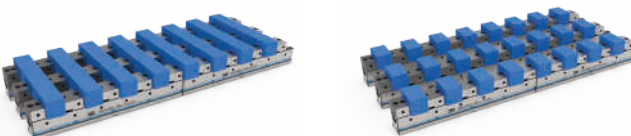

MONTAGGIO IN LINEA - IN LINE MOUNTING

6 morse - Serraggio di 8 particolari
 6 vises - 8 workpieces clamped

6 morse - Serraggio di 24 particolari
 6 vises - 24 workpieces clamped

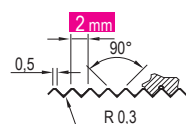

2 mm
 Passo delle righe
 Rows pitch

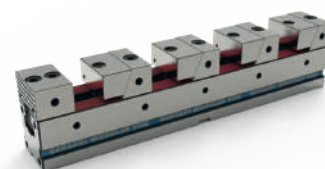

Versatilità - Versatility

Possibilità di posizionare, aggiungere o rimuovere le ganasce su qualsiasi posizione della dentatura della base.

Possibility of jaws positioning, addition or remove on whatever position on the vise base teeth



Massima precisione Highest accuracy

Garantita la massima precisione di posizionamento ed allineamento delle ganasce e delle morse grazie alla rettificatura dal pieno della dentatura di ancoraggio della base.

Highest accuracy guaranteed in positioning and alignment ($\pm 0,02\text{ mm}$) thanks to the ground rack teeth on both the base and the fixed jaws.

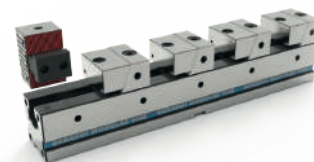

Azione discendente Pull down jaw action

Cuneo di spinta guidato grazie al sistema a pettine con righe rettificata sulla ganasce fissa e mobile.

Wedge clamps with guided pull-down law action thanks to the ground comb-teeth even between the fixed and movable jaws

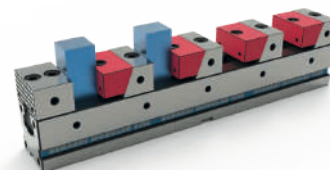

Le morse della serie MULTIFLEX rappresentano un innovativo sistema modulare di serraggio in grado di sfruttare al massimo la capacità della tavola della macchina e di aumentarne, di conseguenza, la produttività. Il sistema è stato ideato per poter serrare contemporaneamente un notevole numero di pezzi sulla tavola della macchina utensile, riducendo così notevolmente i tempi morti.

The MULTIFLEX series vises are a total new concept of modular clamping system able to maximize the machine table capacity and thus to increase its productivity. This system is designated for clamping several workpieces at the same time on the machine tool table, thus reducing tool changeover times.

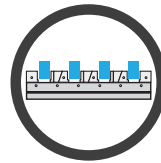

SCAN IT TO SEE



THE WEB PAGE



Le morse più versatili!
The most versatile vises!

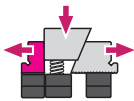

Ganascia fissa e mobile
 con gradino per il sollevamento del particolare
 Fixed & Movable Jaw
 with step to rise up the workpiece

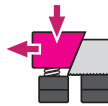

Ganascia fissa e mobile
 per particolari in appoggio sulla base
 Fixed & Movable Jaw
 with step to rise up the workpiece

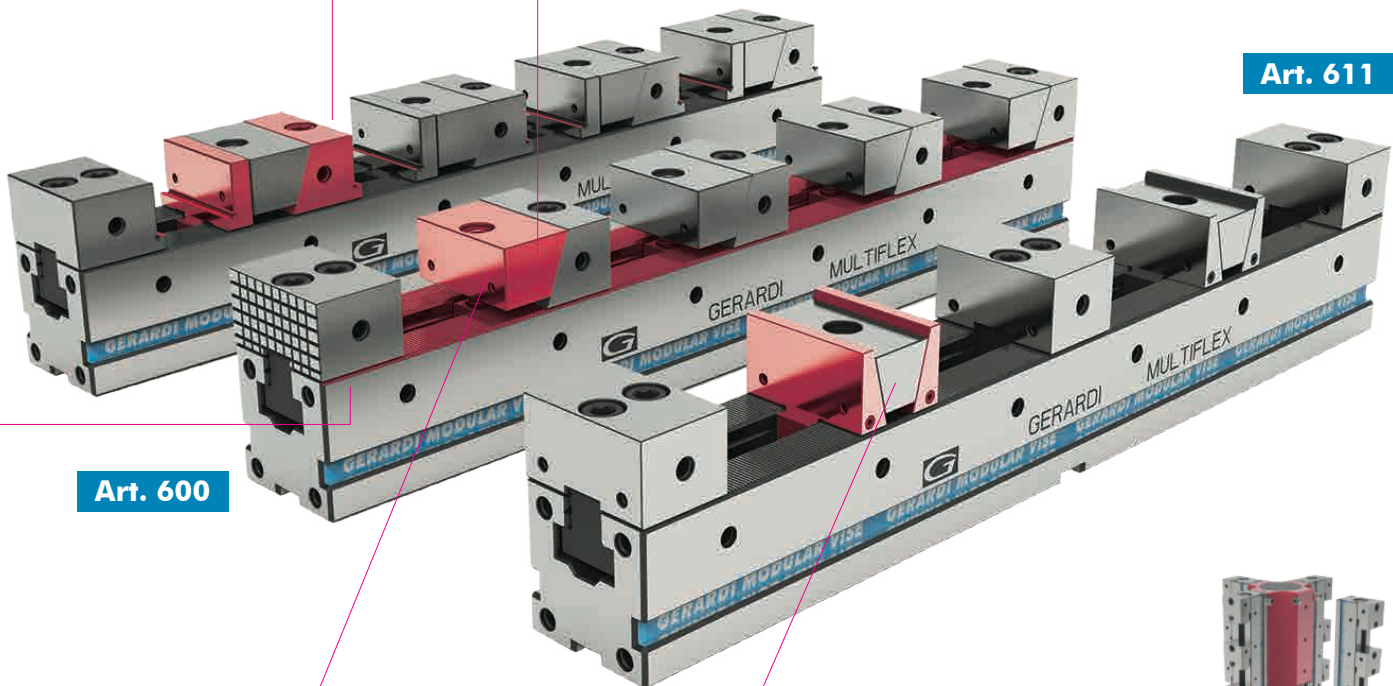
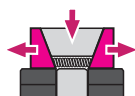
Art. 606
Art. 611

Art. 600

Cuneo di spinta
 Per il serraggio simultaneo di 2 particolari
 Clamping Wedge
 To the clamp of 2 workpieces simultaneously

Montaggio Verticale Vertical Set-Up



Tramite distanziali, strutture portapezzi o cubi-morsa verticali. Le morse modulari MULTIFLEX possono essere assemblate verticalmente, legate fra loro o montate su specifiche strutture portapezzi.

Through spacers, tombstones or vise-towers. MULTIFLEX vises can be vertically assembled linked each other or clamped to specific workholding structures.

Staffe d'ancoraggio / Vise holding clamps

NEW
2024

MULTIFLEX

Coppia staffe di fissaggio Art.296, complete di vite e dado a "T"
Pair of vise holding clamps Art.296 complete of screw and "T" nuts

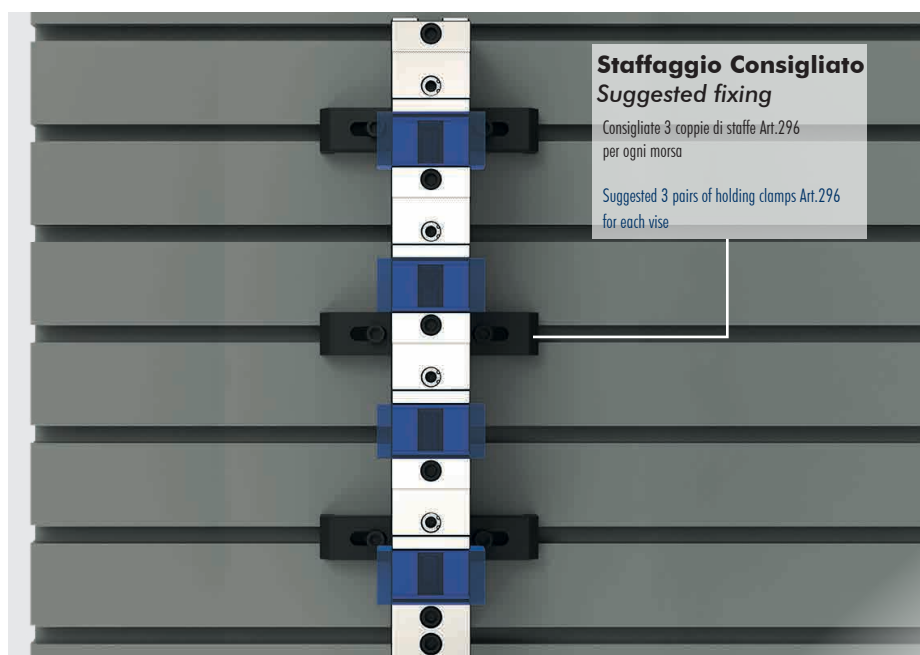
Esempio d'ordine per morsa tipo 3 su macchina con cave a T da 18mm: Art.296 T.3 X=18mm
Oppure con codice: 2.29.6200 X=18mm
Order example for Type 3 vise on machine with 18mm T-slots: Art.296 T.3 X=18mm
Also with code: 2.29.6200 X=18mm

Staffaggio Consigliato
Suggested fixing

Consigliate 3 coppie di staffe Art.296 per ogni morsa

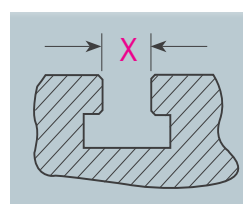
Suggested 3 pairs of holding clamps Art.296 for each vise

Cava a T
T Slot

Specificare sempre la cava della vostra macchina

Always specify the machine T-slot dimension

Ref N° Pag.4.34

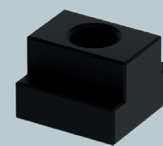
Art.287
Dadi a T - T Nuts

Per fissaggio morse alle cave a T della macchina

For vise clamping on the machine T-slots

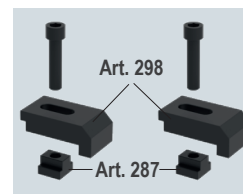
Art.296

(Art.298 + Art.287)

Consigliate 3 coppie di staffe Art.296 per ogni morsa

Suggested 3 pairs of holding clamps Art.296 for each vise

Tipo (grandezza) Type (size)	1				1								2 - 3								
Art. 296	Cava a T slot X	12	14	16	18	12*	14	16	16	18	20	18*	20	22	16	18	20	22	18*	20	22
	T-nuts Ref. N°	8	9	10	11	12	13	14	20	21	22	32	33	34	20	21	33	34	32	33	34
Coppia di staffe Holding clamps pair	Filetto vite Screw thread	M8				M10		M12 *		M16		M12			M16 *						
1 X M8 	A	50				50		50		50		76			76						
	B	24				24		24		24		30			30						
	C	6				6		6		6		6			6						
	Ø D	8,5				11		13		17		13			17						
	E	10				10		10		10		13			13						
	Ø F	14				-		-		-		-			-						
	G / G1	14				16/15		17,5/13		19/9		17/22			16/15						
	H	34				34		34		34		42			42						
	I	8				10		10		10		-			-						
	J	4				4		4		4		10			10						
T ± 0,1	15				15		15		15		20			20							
	Cod.	2.29.61000 / M8				2.29.61000 / M10		2.29.61000 / M12		2.29.61000 / M16		2.29.63000 / M12			2.29.63000 / M12						

* Scelta consigliata - Suggested choice

* Scelta NON consigliata - NOT Suggested choice

Soluzioni personalizzate / Customized solutions

MULTIFLEX

Soluzioni personalizzate a tutti i vostri problemi di serraggio

Customized solutions for all your clamping problems



Morse Multiflex montate verticalmente

Multiflex vises vertically mounted

Cubo portapezzi Art.53C con 8 morse Multiflex Art.606 2x600 montato su Matsura H.Plus 400 per serraggio di 32 pezzi

Tombstone Art.53C with 8 Multiflex vises Art.606 2x600 mounted on Matsura H.Plus 400 for 32 pcs clamping



Morse Multiflex

Multiflex vises

Morse Multiflex montate in parallelo su centro di lavoro verticale per serraggi multipli

Multiflex vises mounted in parallel on vertical machining centre for multiple clamping



Cubo Multiflex

Multiflex vise tower

Particolari fuori dimensione, ma lavorati su cubo Multiflex Art.607 tipo 2

Rather big work-pieces machined on a Multiflex vise tower Art.607 Type 2



Morse Multiflex su quarto asse

Multiflex vises on 4th axis

Morsa Multiflex con relativa piastra di interfaccia montata su quarto asse

Multiflex vise with interface plate assembled on 4th axis



Morse Multiflex

Multiflex vises

Morse Multiflex Art.611 Tipo 1x700mm con ganasce doppie montate su centro di lavoro HAAS per serraggio di 2 particolari, uno fuori dimensione ed uno molto più piccolo

Multiflex vises Art.611 Type 1x700mm with double jaws shown on Haas machining centre for 2 workpieces clamping, one rather big and the other much smaller.

VALIGETTA DI CAMPIONATURA STD (Art.600)

SAMPLE KIT CASE STD (Art.600)

Art. 984

Art.600 T.1x400



Morsa / Vise Art. 600

Cod. 0.98.40000

Art. 600 - All'Interno - Inside:

Art.604	Art.605	Art.609	Art.613
Art.615	Art.605L	Art.610B	Art.610C
Art.610D	Art.610E	Art.610F	Art.610T
Art.297	Art.298	Art.370	Art.375
Art.376			

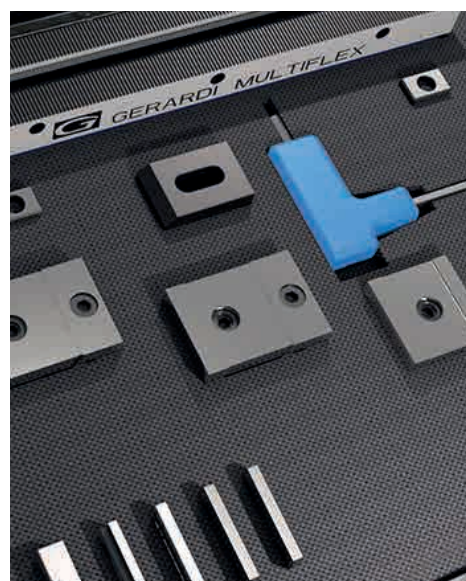

SIMBOLOGIA DATI TECNICI

TECHNICAL DATA ICONS

GANASCE JAWS				
	Fissa Fixed	Mobile e fissa Fixed and movable	Mobile e fissa a gradino Fixed and movable with step	Mobile doppia Double movable
PIASTRE GANASCE JAW PLATES				
			Piana Straight	GRIP integrale Integral GRIP

POSSIBILITÀ POSSIBILITY				
	Predisposi- zione Zero Point Zero Point Ready	Cubi-morsa Vise tower	Divisore automatico Dividing head	Divisore Meccanico Mechanical dividing head
PAGINE PAGES				
		Accessori & Ricambi Accessories & Spare Parts	Istruzioni corretto utilizzo Instruction for a proper use	Diagrammi forze di seraggio Clamping force diagrams

OPZIONI LAVORAZIONI EXTRA

OPTIONS FOR EXTRA MACHINING

Nei codici, **FMS** si riferisce agli articoli dei gruppi 5, 6 e 7.
 In codes, **FMS** refers to articles in groups 5, 6 and 7.

Lavorazione extra Extra machining	Cod.
AGGIUNTA di un foro calibrato. ADDITION of a calibrated hole.	MAN-010-FMS
AGGIUNTA di una chiave calibrata. ADDITION of a calibrated key-way.	MAN-020-FMS
PREDISPOSIZIONE SEMPLICE SIMPLE SET UP	MAN-030-FMS
PREDISPOSIZIONE & MONTAGGIO COMPLETO COMPLETE SET UP & MOUNTING	MAN-040-FMS
MONTAGGIO PARZIALE PARTIAL ASSEMBLY	MAN-050-FMS

Lavorazione extra Extra machining	Cod.
MONTAGGIO SEMPLICE SIMPLE ASSEMBLY	MAN-060-FMS
MONTAGGIO ed ALLINEAMENTO (Standard) (Standard) ASSEMBLY and ALIGNMENT	MAN-070-FMS
MONTAGGIO VERTICALE COMPLETE VERTICAL ASSEMBLY	MAN-080-FMS
ALLINEAMENTO e CONTROLLO tramite DEA. ALIGNMENT and CONTROL by DEA \ CMM.	MAN-090-FMS
TABULATO controllo DEA PRINTOUT DEA control	MAN-100-FMS

Vedi pagina 6.44 per esempi applicativi - See page 6.44 for application examples