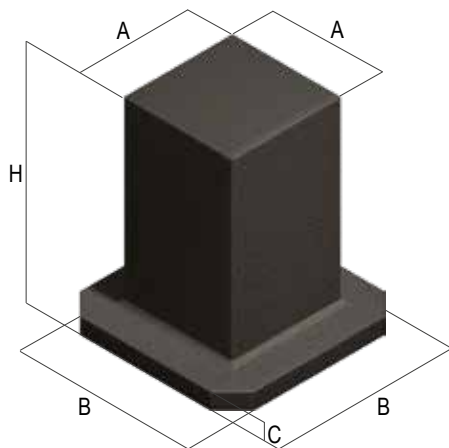

CUBI - CUBES
Art. 53A

General tolerance +12 +8 mm

Dimensioni - Dimensions

A	B	C	H	kg	Cod.
90	260	45	410	44	8.53.A00009
170	260	50	300	66	8.53.A00020
210	325	50	310	96	8.53.A00030
210	360	50	380	119	8.53.A00040
210	360	50	535	153	8.53.A00045
210	510	50	610	217	8.53.A00050
260	410	50	460	179	8.53.A00060
260	460	50	460	195	8.53.A00070
260	410	50	560	207	8.53.A00080
260	410	50	670	239	8.53.A00081
260	390	40	570	239	8.53.A00082
260	510	50	620	258	8.53.A00090
260	510	50	660	270	8.53.A00100
260	510	50	760	298	8.53.A00105
260	640	50	710	337	8.53.A00106
260	510	50	1010	368	8.53.A00107
280	410	50	520	210	8.53.A00110
310	510	50	610	293	8.53.A00111
310	510	50	760	345	8.53.A00113
310	510	50	910	397	8.53.A00115
340	510	50	670	335	8.53.A00120
360	510	50	420	252	8.53.A00140
360	510	50	460	268	8.53.A00150
360	510	50	560	310	8.53.A00160
360	510	50	620	334	8.53.A00170
360	510	50	710	372	8.53.A00171
360	640	50	710	425	8.53.A00172
360	640	50	830	496	8.53.A00180
360	510	50	830	420	8.53.A00181
360	640	50	960	529	8.53.A00185
460	640	50	560	431	8.53.A00190
460	640	50	660	486	8.53.A00200
510	640	50	870	655	8.53.A00211
560	760	50	860	763	8.53.A00220
510	810	50	810	704	8.53.A00230
640	810	50	1100	1623	8.53.A00235

Art. 53B

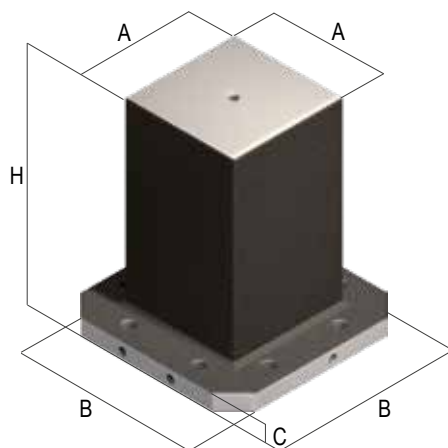
 Base finita
 Base finished

General tolerance +12 +8 mm

Dimensioni - Dimensions

A	B	C	H	kg	Cod.
90	250	40	400	40	8.53.B00009
170	250	45	290	61	8.53.B00020
210	315	45	300	89	8.53.B00030
210	350	45	370	112	8.53.B00040
210	350	45	525	147	8.53.B00045
210	500	45	600	203	8.53.B00050
260	400	45	450	169	8.53.B00060
260	450	45	450	183	8.53.B00070
260	400	45	550	197	8.53.B00080
260	400	45	660	228	8.53.B00081
260	380	35	560	228	8.53.B00082
260	500	45	610	244	8.53.B00090
260	500	45	650	255	8.53.B00100
260	500	45	750	284	8.53.B00105
260	630	45	700	316	8.53.B00106
260	500	45	1000	355	8.53.B00107
280	400	45	510	198	8.53.B00110
310	500	45	600	278	8.53.B00111
310	500	45	750	330	8.53.B00113
310	500	45	900	383	8.53.B00115
340	500	45	660	321	8.53.B00120
360	500	45	410	236	8.53.B00140
360	500	45	450	253	8.53.B00150
360	500	45	550	294	8.53.B00160
360	500	45	610	319	8.53.B00170
360	500	45	700	356	8.53.B00171
360	630	45	700	403	8.53.B00172
360	630	45	820	452	8.53.B00180
360	500	45	820	403	8.53.B00181
360	630	45	950	508	8.53.B00185
460	630	45	550	409	8.53.B00190
460	630	45	650	463	8.53.B00200
510	630	45	860	631	8.53.B00211
560	750	45	850	732	8.53.B00220
510	800	45	800	671	8.53.B00230
640	800	45	1050	1565	8.53.B00235

Art. 53C

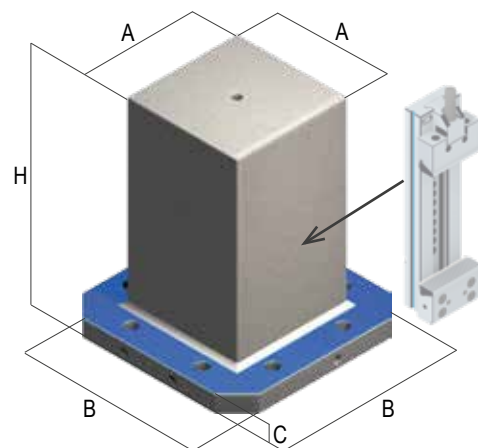
 Completamente lavorati
 Completely machined

General tolerance ± 0,02 mm

Dimensioni - Dimensions

A	B	C	H	kg	Cod.
80	250	35	400	33	8.53.C00009
160	250	40	290	54	8.53.C00020
200	315	40	300	79	8.53.C00030
200	350	40	370	99	8.53.C00040
200	350	40	525	128	8.53.C00045
200	500	40	600	179	8.53.C00050
250	400	40	450	150	8.53.C00060
250	450	40	450	164	8.53.C00070
250	400	40	550	174	8.53.C00080
250	400	40	660	201	8.53.C00081
250	380	30	560	201	8.53.C00082
250	500	40	610	215	8.53.C00090
250	500	40	650	225	8.53.C00100
250	500	40	750	249	8.53.C00105
250	630	40	700	279	8.53.C00106
250	500	45	1000	310	8.53.C00107
270	400	40	510	176	8.53.C00110
300	500	40	600	247	8.53.C00111
300	500	40	750	293	8.53.C00113
300	500	40	900	338	8.53.C00115
330	500	40	660	287	8.53.C00120
350	500	40	410	212	8.53.C00140
350	500	40	450	226	8.53.C00150
350	500	40	550	263	8.53.C00160
350	500	40	610	284	8.53.C00170
350	500	40	700	317	8.53.C00171
350	630	40	700	359	8.53.C00172
350	630	40	820	402	8.53.C00180
350	500	40	820	358	8.53.C00181
350	630	40	950	450	8.53.C00185
450	630	40	550	367	8.53.C00190
450	630	40	650	415	8.53.C00200
500	630	40	860	565	8.53.C00211
550	750	40	850	656	8.53.C00220
500	800	40	800	600	8.53.C00230
630	800	40	1050	1556	8.53.C00235

Modelli normalmente presenti a magazzino

! Per lavorazioni o materiali diversi (alluminio), richiedere quotazione specifica

Portapezzi

TOMBSTONES

Cubi, spalle, squadre, piastre, pallets

Cubes, 2 sides tombstones, Angle plates, plates



Precisione / Accuracy
 $\pm 0,005\text{mm}$



Durezza / Hardened
HRC 58 \pm 2

QUALITÀ GERARDI

- 1 - FUSIONE MONOBLOCCO IN GHISA G30
- 2 - DOPPIO TRATTAMENTO TERMICO DI DISTENSIONE
- 3 - LAVORAZIONE COMPLETA DI FRESATURA E PREDISPOSIZIONE PER NOSTRO SISTEMA ZERO POINT
- 4 - DISTENSIONE NATURALE DI RIPOSO MINIMO 48 ORE
- 5 - RASCHIETTATURA BASE D'APPOGGIO PER UNA PLANARITA' PERFETTA
- 6 - LAVORAZIONE COMPLETA DI FINITURA
- 7 - ESECUZIONE DI FORI O CAVE DI POSIZIONAMENTO E CENTRAGGIO PORTAPEZZO SULLA BASE D'APPOGGIO RASCHIETTATA
- 8 - CONTROLLO DIMENSIONALE PORTAPEZZO
- 9 - EVENTUALE RITOCOCCO TRAMITE RASCHIETTATURA PER RIPORTARE IL PORTAPEZZO NELLA PERPENDICOLARITA', ORTOGONALITA' E PARALLELISMO PREVISTI
- 10 - IDENTIFICAZIONE TRAMITE NUMERO DI MATRICOLA INCISO SUL PORTAPEZZO CON ALLEGATO CERTIFICATO DI COLLAUDO

GERARDI QUALITY

- 1 - INTEGRAL CAST IRON G30 CASTING
- 2 - DOUBLE STRESS RELIEVING HEAT TREATMENT
- 3 - COMPLETE ROUGH MILLING WORK AND PREARRANGED WORK FOR THE USE OF OUR ZERO POINT GERARDI SYSTEM
- 4 - NATURAL 48 HOURS STRESS RELIEVING
- 5 - HAND SCRAPING OF BOTTOM BASE FACE FOR A PERFECT PLANARITY
- 6 - COMPLETE MACHINE FINISHING
- 7 - BASE FACE TAILOR-MADE, TOMBSTONE CENTERED ON THE HAND SCRAPE BASE PLATE
- 8 - DIMENSIONAL CONTROL AND QUALITY CHECK
- 9 - SOME HAND-SCRAPED COULD BE MADE IN ORDER TO GET A PERFECT - PARALLELISM - ORTHOGONALITY AND PERPENDICULARITY WITHIN THE QUOTED TOLERANCES.
- 10 - PART IDENTIFICATION ENGRAVED ON THE PRODUCT WITH INSPECTION SHEET INCLUDED.



Soluzioni Speciali

Specific Tombstones

Soluzioni speciali e personalizzate integrate con sistemi di bloccaggio adeguati possono essere studiate e realizzate su richiesta per sfruttare al meglio il campo di lavoro e le capacità delle macchine.

Specific or tailor-made tombstones complete with clamping systems applications could be studied and manufactured on request in order to better exploit the machines runs and capacity



Cubo a croce
 Cross cube

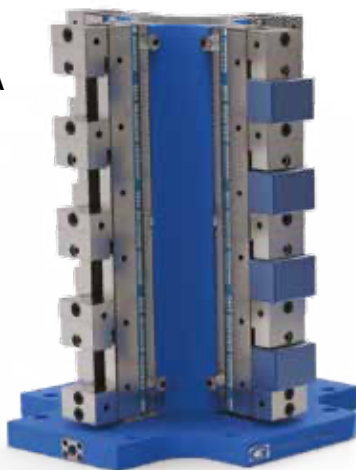

Cubo a reticolo
 Grid Cube

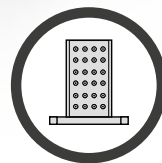

Predisposizione Zero Point

Zero Point Ready

Predisposizione della base di appoggio di 4 fori Ø20F7 e filetto M16 con interassi precisi, pronte per l'utilizzo dei ns. Zero point, oppure per l'interfacciamento con altri pallett o piastre.

Base with 4 precision holes Ø 20F7 and bottom threads M16 with precise pitch dimensions for the use of our Zero Point or to be interfaced with other pallets or head plates

A supporto ed integrazione dei sistemi di bloccaggio la GERARDI ha progettato e via via sviluppato una gamma di portapezzi in fusioni monoblocco di ghisa G30 (con pareti spessore 43-45mm circa e con doppio trattamento di distensione e stabilizzazione) e recentemente anche di alluminio speciale ad alta resistenza. Tali prodotti possono essere forniti nelle forme di: Cubi, Spalle, Squadre, Piastre, Mensole e speciali a richiesta. L'importanza sempre maggiore di questi prodotti deriva dallo sviluppo e diffusione di centri di lavoro orizzontali e sistemi pallettizzati che richiedono appunto tali strutture di supporto per le attrezzature o per i pezzi da lavorare stessi. I controlli vengono eseguiti con macchine tridimensionali su ogni pezzo eseguito.

To support and complete the Gerardi Modular Workholding System a more and more strategic and important role is played by all the range of modular tombstones and sub-plates. They are manufactured in the most different shapes and versions, anyway always provided in one solid cast iron cast G30 with walls about 40 mm thickness and with double stress relieving heat treatment. Recently in high resistance aluminum. The shapes available are: Cubes, Two side tombstone, Angles, Plates and subplates, Shelves and special on specific request. The greater importance of such products originates from the development and widespread of Horizontal machining centres and multipallet systems which require just such structures to support the fixtures or work-pieces. The checking is carried out piece by piece on a 3-dimensional machine.

Cubo leggero Light Cube



Nuova serie di cubi ALLEGGERITA con pareti di spessore 20/25mm ideali per centri di lavoro ad alta velocità
 New cubes light series with wall reduced thickness 20/25mm ideal for high speed machine

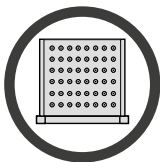
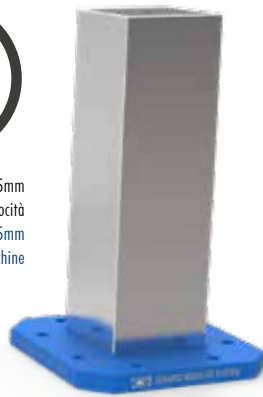

Spalla a reticolo 2 side tombstone



Qualsiasi modifica, lavorazione o personalizzazione extra sarà eseguita previo preventivo. Per le versioni speciali pagamento 50% all'ordine. Il ns. ufficio tecnico è a Vs. disposizione per eventuali chiarimenti e consegne

Any special requirement will be quoted "Extra" for special type payment 50% on order. Our technical department is always available for any explanations or delivery time

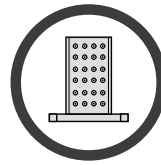

Per centri di lavoro orizzontali For horizontal machining centre

DISPONIBILI IN 5 VERSIONI DIVERSE AVAILABLE IN 5 DIFFERENT FINISHING



Versione A - Type A

FUSIONE IN GHISA - CAST IRON CASTING

Fusione in ghisa G30 monoblocco con doppio trattamento di distensione. Pareti spessore 43-45 mm (Sovrametallo 10 mm)
 *Alcuni modelli indicati non vengono sgrassati

One integral G30 cast iron casting with double stress relieving heat treatment. Wall thickness 43-45 mm (10 mm stock)
 *Few highlighted items are not rough milled



Versione B - Type B

BASE FINITA - BASE FINISHED

Fusione con base lavorata e raschiata per pallet a norme Europee o Giapponesi.

Casting with base face machined and hand scraped for direct clamping on European or Japanese standard pallet.



Versione C - Type C

COMPLETAMENTE LAVORATI - COMPLETELY FINISHED

Cubo completamente finito con pareti spessore 38-40 mm circa. Tolleranza $\pm 0,02$ mm

Cube completely finished with wall thickness roughly 38-40 mm. Tolerance $\pm 0,02$ mm

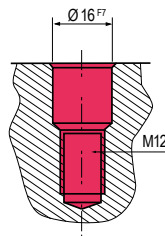

Versione E - Type E

RETICOLO INTEGRALE - GRIND CUBE

Cubo a reticolo con fori calibrati e filetti integrali nella fusione. Tolleranza $\pm 0,02$ mm

Integral cube with calibrated holes and solid threads in the casting itself. Tolerance $\pm 0,02$ mm

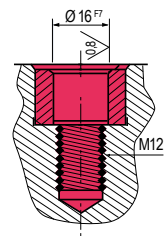

Versione F - Type F

RETICOLO CON BUSSOLE - GRID CUBE WITH BUSHINGS

Cubo a reticolo con bussole di centraggio in acciaio temprato 100 Cr6 - DIN 179C. Filetti riportati in acciaio inox 18/8. Tolleranza $\pm 0,02$ mm

Integral cube with centering bushings in special hardened alloy steel 100Cr6 - DIN 179C. Inserted threads are in 18/8 stainless steel. Tolerance $\pm 0,02$ mm

INTERFACCIAMENTO STANDARD

STANDARD INTERFACE

STANDARD EUROPEO EUROPEAN STANDARD

A	400	500	630	800
B	-	-	-	-
C	80	100	125	160
B	-	-	-	-

STANDARD GIAPPONESE (Normativa JIS) JAPANESE STANDARD (Normative JIS)

A	400	500	630	800
B	55	75	100	135
C	80	100	125	160
B	55	75	100	135

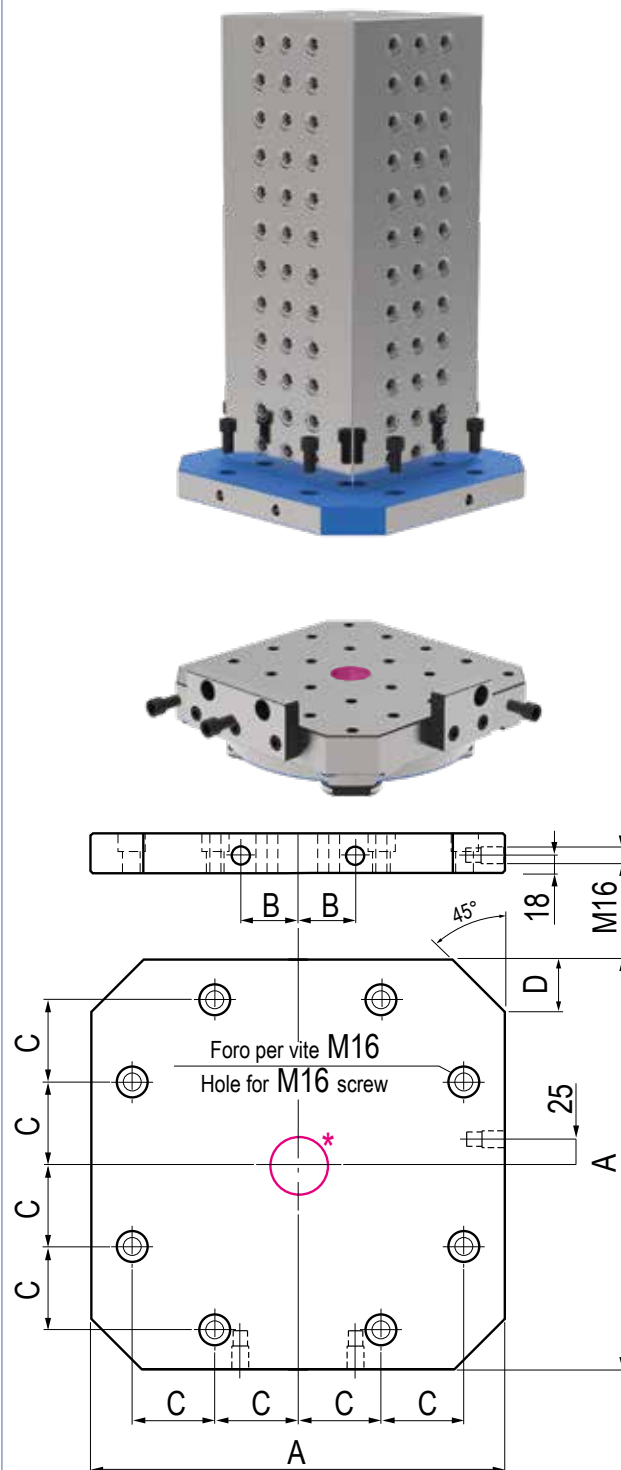
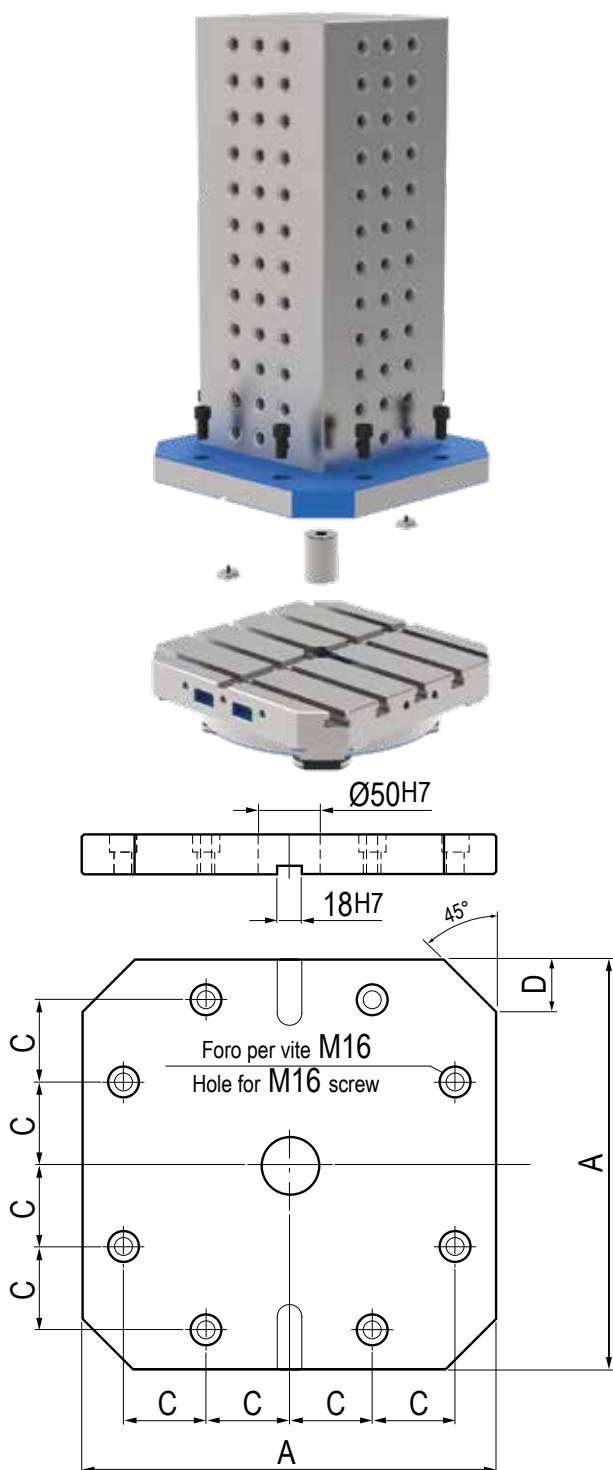

Foro centrale (OPZIONE)* - Central hole (OPTIONAL)*

COME LAVORARE I PORTAPEZZI, TRAMITE ZERO POINT E STAFFE INTELLIGENTI

HOW TO MACHINE TOMBSTONES WITH ZERO POINT AND INTELLIGENT CLAMPS

Tutti i ns. portapezzi (escluso la fusione grezza), sono predisposti, sulla base di appoggio con forature e filettature per l'uso dei tiranti

Zero-Point Art.11A T.2 Questo principalmente significa che tutti i ns. portapezzi possono essere velocemente fissati, posizionati e lavorati sulle 5 facce senza nessun impedimento per quanto riguarda il percorso utensili.

All our tombstone fixture (rough cast iron casting excluded) are pre-worked and prepared on the bottom base face for our Zero-Point pull-stud Art.11A T.2. This important feature will give you many possible application.

Fig.1
Pic.1

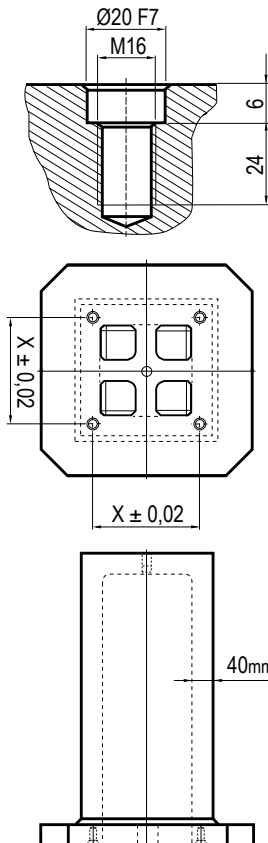

* Sulle superfici grezze aggiungere 5mm
 * Add 5mm on the rough surfaces

Fig.2
Pic.2

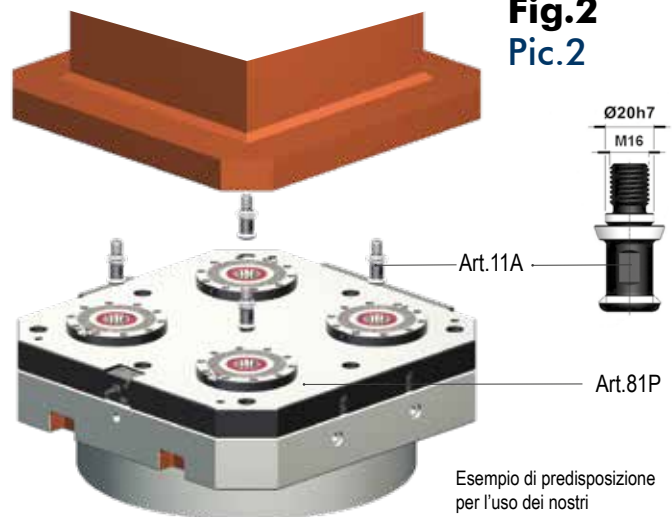

Esempio di predisposizione per l'uso dei nostri "Zero Point System"
 Prearranged work for the use of our "Zero Point System"

Per montaggio, posizionamento e ancoraggio istantaneo con necessità di collegamento pneumatico solo per lo sbloccaggio. Il bloccaggio è meccanico tramite molle. Con questo sistema il pallet può tranquillamente essere movimentato senza l'ausilio di collegamenti elettrici, elettronici, idraulici o pneumatici.

Quick clamping and accurate positioning set up of your tombstone through pneumatic source (only for unclamping - clamping is mechanically maintained by springs)
 With this system your pallet could easily travel without the need of electrical pneumatic or electronic connection.

Fig.3
Pic.3

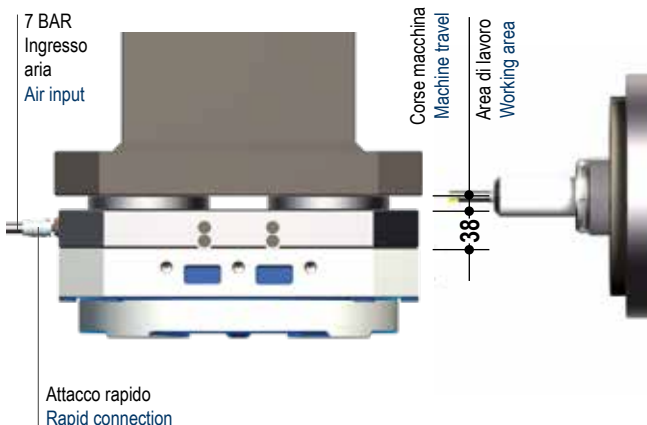

Gli "Zero Point Gerardi" sono utilizzabili anche per ottimizzare le corse del Vs. centro orizzontale sollevando il pezzo all'altezza desiderata senza l'ausilio di sovravole.

Our hydraulic or pneumatic "Zero Point Gerardi" are also used to optimize the vertical travel of your horizontal machining center without the need of extra over pallet plates.

Fig.4
Pic.4

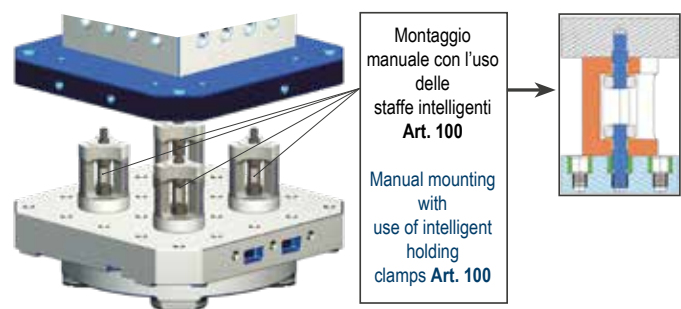

I fori di predisposizione (Fig.1- pag. 8.5) possono essere usati anche per l'utilizzo di "staffe intelligenti" Art.100 e relativi prigionieri.

The pre-work holes (Pic.1- pag. 8.5) are also coming handy for the use of our "intelligent clamps" Art. 100

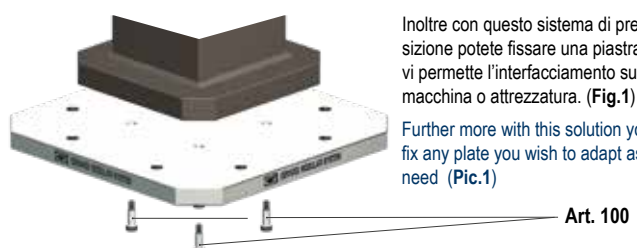

Inoltre con questo sistema di predisposizione potete fissare una piastra che vi permette l'interfacciamento sulla Vs. macchina o attrezzatura. (Fig.1)

Further more with this solution you can fix any plate you wish to adapt as you need (Pic.1)

Art. 100



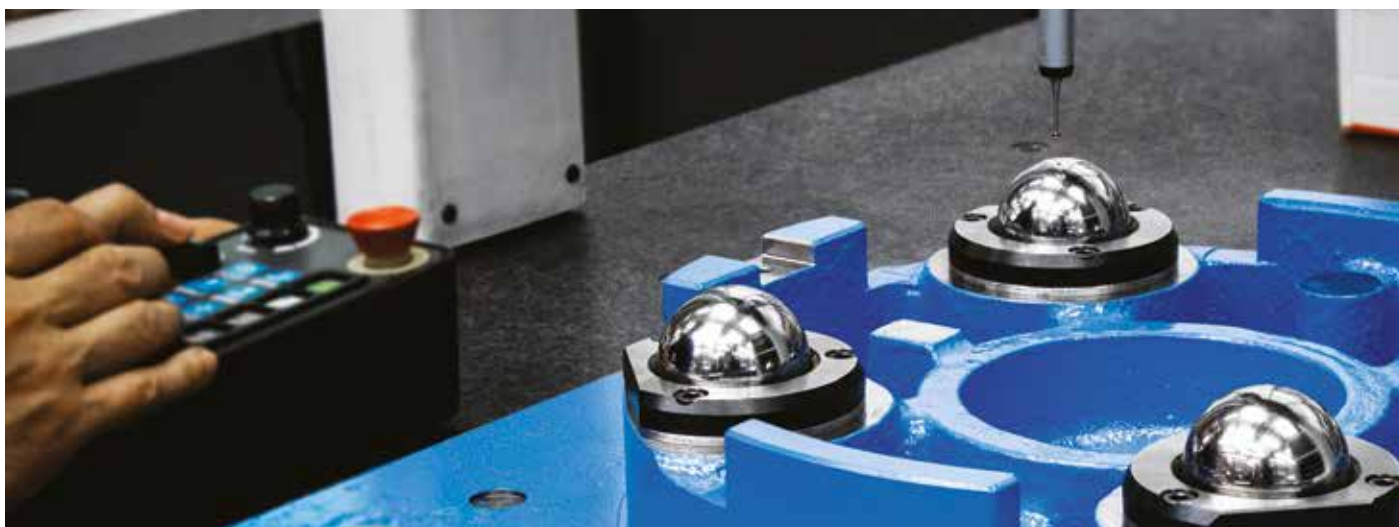

VERIFICHE DIMENSIONALI TRAMITE MACCHINE DI MISURA

DIMENSIONAL CHECK THROUGH MEASUREMENT MACHINES

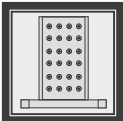
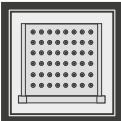

SIMBOLOGIA DATI TECNICI

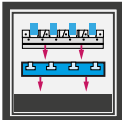
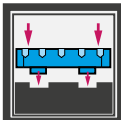
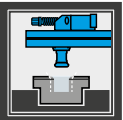
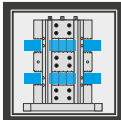
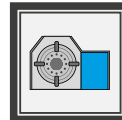
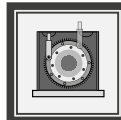
TECHNICAL DATA ICONS

MODELLI PORTAPEZZI TOMBSTONE MODELS			 Cubi Cubes	 Spalle 2 Sides tombstones	 Cubi a croce Cross cubes	 Squadre Angles
PIASTRE E PALLET PLATES AND PALLET					 Piastre e sovratavole Plates & Interfaced plates	 Pallet macchina Machine pallet
POSSIBILITÀ DI POSSIBILITY OF			 Posizionamento & cambio rapido Quick change & positioning	 Cubi-morsa Vise tower	 Divisore Automatico Automatic dividing head	 Divisore Meccanico Mechanical dividing head
PAGINE PAGES					 Accessori & Ricambi Accessories & Spare Parts	 Istruzioni corretto utilizzo Instruction for a proper use