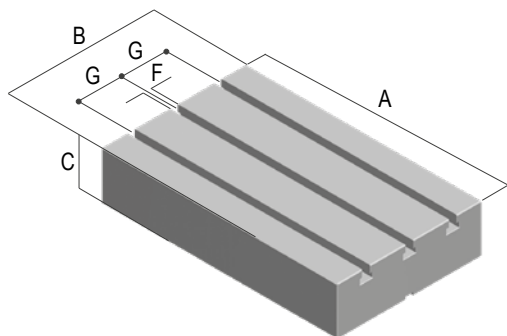

SOVRATAVOLA - BASE PLATES
ACCIAIO - STEEL METAL Fe420
Dimensioni - Dimensions (mm)

A	B	C	F	G	Kg	Cod.
420	230	98	16	70	75	8.86.G230420A
490	300	98	16	100	105	8.86.G300490A
630	370	98	16	100	170	8.86.G370630A
630	630	98	16	100	290	8.86.G630630A
800	550	98	16	100	320	8.86.G550800A*
800	800	98	16	100	480	8.86.G800800A
900	410	98	16	100	280	8.86.G410900A*
900	460	98	16	100	310	8.86.G460900A*
1000	550	98	16	100	410	8.86.G5501000A
1200	550	98	16	100	502	8.86.G5501200A
1240	550	98	16	100	518	8.86.G5501240A*
1740	750	98	16	100	960	8.86.G7501740A*
900	400	68	16	100	201	8.86.G400900A*
1000	400	68	16	100	224	8.86.G4001000A*
1100	400	68	16	100	245	8.86.G4001100A*
1200	380	78	16	100	262	8.86.G3801200A*
1600	380	78	16	100	389	8.86.G3801600A*
2000	380	78	16	100	437	8.86.G3802000A*
800	500	68	16	100	224	8.86.G500800A*
900	500	68	16	100	252	8.86.G500900A*
1000	500	68	16	100	280	8.86.G5001000A*
1100	500	68	16	100	308	8.86.G5001100A*
1200	500	68	16	100	336	8.86.G5001200A*
1400	500	68	16	100	392	8.86.G5001400A*

Art. 86G

 Piastra base con cave H7
 H7 T-slots base plate

* Misure disponibili a richiesta - Sizes available on request

SOVRATAVOLA - BASE PLATES
ACCIAIO - STEEL METAL Fe420
Dimensioni - Dimensions (mm)

A	B	C ^{H7}	D	G	Kg	Cod.
400	125	14	140	50	46	8.94.400125
600	125	14	140	50	68	8.94.600125
800	125	14	140	50	92	8.94.800125
1000	125	14	140	50	114	8.94.1000125

Art. 94

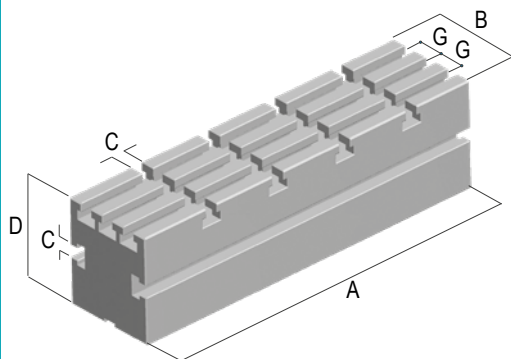
 Supporto base con cave H7 temprato
 H7 T-slots support base plate case hardened

 Materiale: acciaio cementato e temprato 55HRC ± 2
 Material: case-hardened steel 55HRC ± 2

! Per lavorazioni o materiali diversi (alluminio), richiedere quotazione specifica - For different finishing and materials (aluminium), ask for specific quotation

INTERFACCIAMENTO STANDARD

STANDARD INTERFACE

STANDARD EUROPEO EUROPEAN STANDARD

A	400	500	630	800
B	-	-	-	-
C	80	100	125	160
B	-	-	-	-

STANDARD GIAPPONESE (Normativa JIS) JAPANESE STANDARD (Normative JIS)

A	400	500	630	800
B	55	75	100	135
C	80	100	125	160
B	55	75	100	135

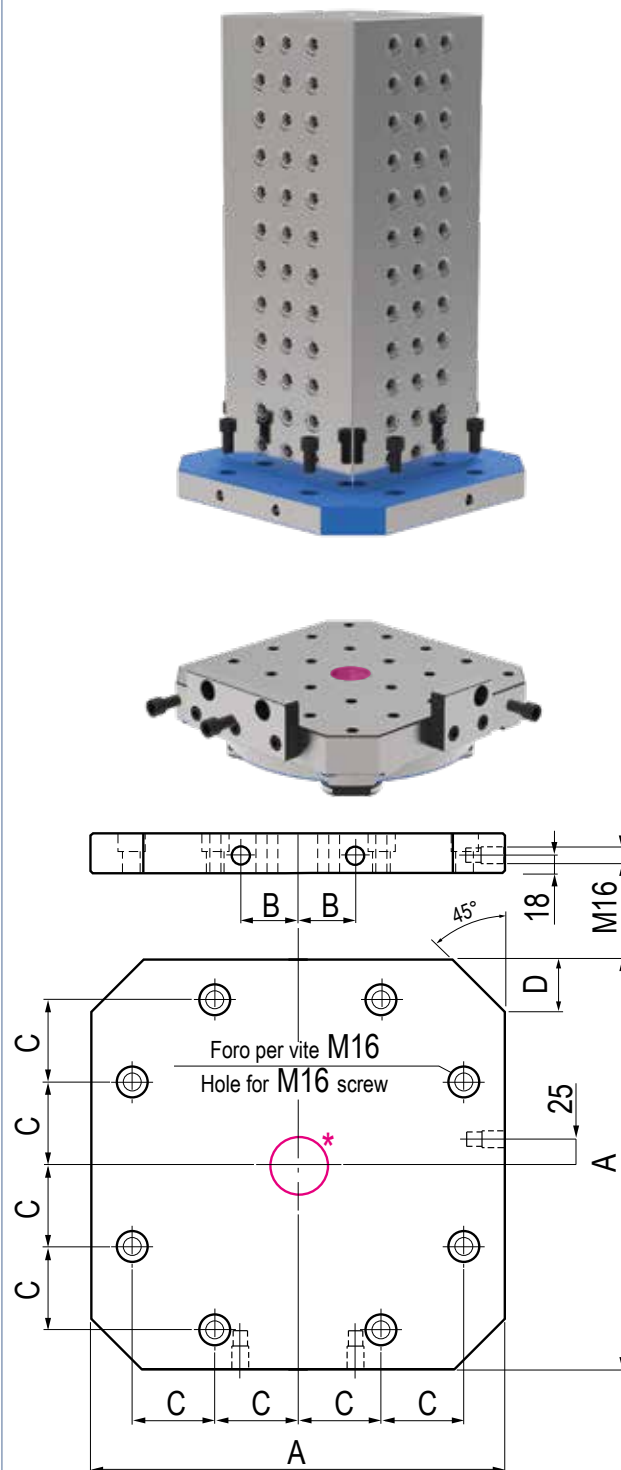
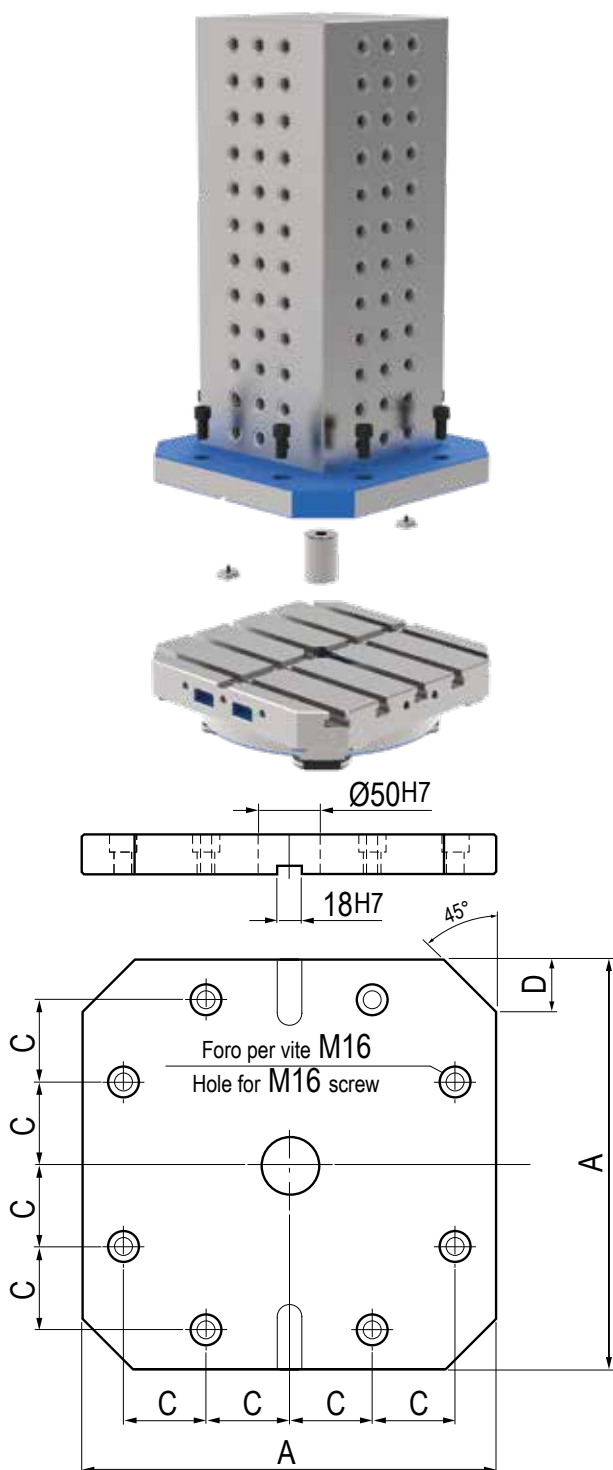

Foro centrale (OPZIONE)* - Central hole (OPTIONAL)*

COME LAVORARE I PORTAPEZZI, TRAMITE ZERO POINT E STAFFE INTELLIGENTI

HOW TO MACHINE TOMBSTONES WITH ZERO POINT AND INTELLIGENT CLAMPS

Tutti i ns. portapezzi (escluso la fusione grezza), sono predisposti, sulla base di appoggio con forature e filettature per l'uso dei tiranti

Zero-Point Art.11A T.2 Questo principalmente significa che tutti i ns. portapezzi possono essere velocemente fissati, posizionati e lavorati sulle 5 facce senza nessun impedimento per quanto riguarda il percorso utensili.

All our tombstone fixture (rough cast iron casting excluded) are pre-worked and prepared on the bottom base face for our Zero-Point pull-stud Art.11A T.2. This important feature will give you many possible application.

Fig.1
Pic.1

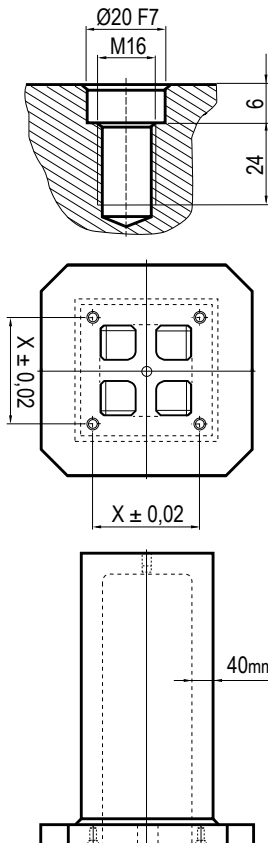

- * Sulle superfici grezze aggiungere 5mm
- * Add 5mm on the rough surfaces

Fig.2
Pic.2

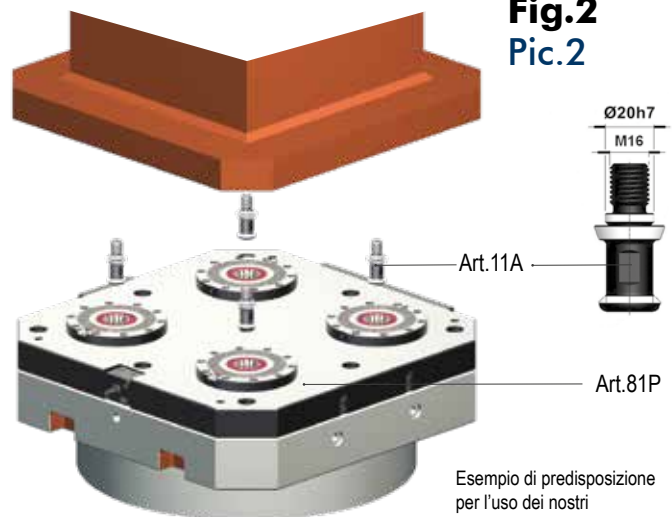

Esempio di predisposizione per l'uso dei nostri "Zero Point System"
 Prearranged work for the use of our "Zero Point System"

Per montaggio, posizionamento e ancoraggio istantaneo con necessità di collegamento pneumatico solo per lo sbloccaggio. Il bloccaggio è meccanico tramite molle. Con questo sistema il pallet può tranquillamente essere movimentato senza l'ausilio di collegamenti elettrici, elettronici, idraulici o pneumatici.

Quick clamping and accurate positioning set up of your tombstone through pneumatic source (only for unclamping - clamping is mechanically maintained by springs)
 With this system your pallet could easily travel without the need of electrical pneumatic or electronic connection.

Fig.3
Pic.3

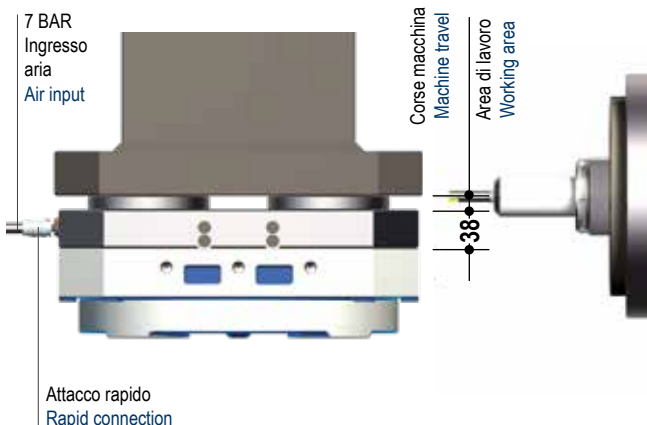

Gli "Zero Point Gerardi" sono utilizzabili anche per ottimizzare le corse del Vs. centro orizzontale sollevando il pezzo all'altezza desiderata senza l'ausilio di sovravole.

Our hydraulic or pneumatic "Zero Point Gerardi" are also used to optimize the vertical travel of your horizontal machining center without the need of extra over pallet plates.

Fig.4
Pic.4

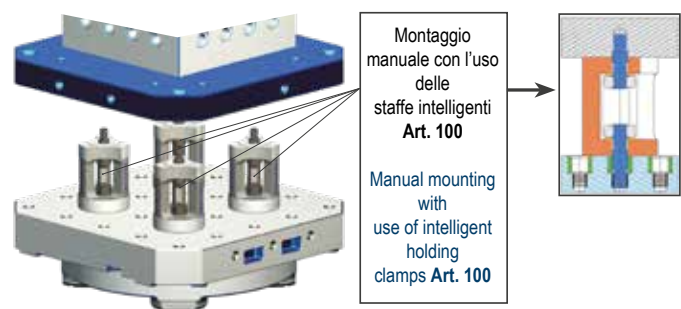

I fori di predisposizione (Fig.1- pag. 8.5) possono essere usati anche per l'utilizzo di "staffe intelligenti" Art.100 e relativi prigionieri.

The pre-work holes (Pic.1- pag. 8.5) are also coming handy for the use of our "intelligent clamps" Art. 100

Montaggio manuale con l'uso delle staffe intelligenti Art. 100
 Manual mounting with use of intelligent holding clamps Art. 100

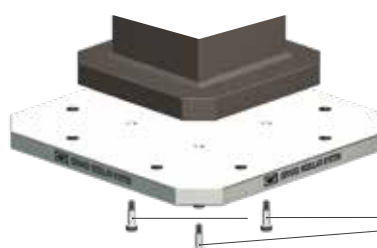

Inoltre con questo sistema di predisposizione potete fissare una piastra che vi permette l'interfacciamento sulla Vs. macchina o attrezzatura. (Fig.1)

Further more with this solution you can fix any plate you wish to adapt as you need (Pic.1)

Art. 100



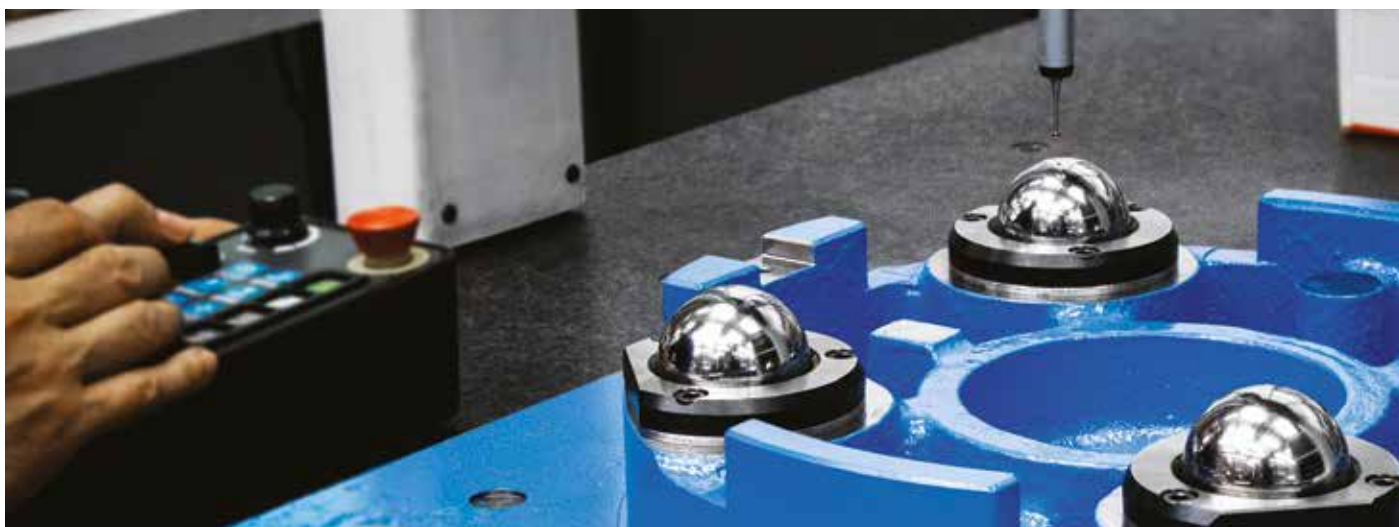

VERIFICHE DIMENSIONALI TRAMITE MACCHINE DI MISURA

DIMENSIONAL CHECK THROUGH MEASUREMENT MACHINES

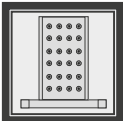
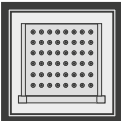

SIMBOLOGIA DATI TECNICI

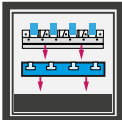
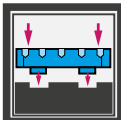
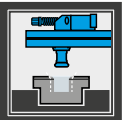
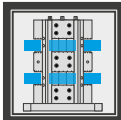
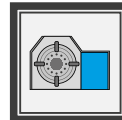
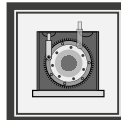
TECHNICAL DATA ICONS

MODELLI PORTAPEZZI TOMBSTONE MODELS			 Cubi Cubes	 Spalle 2 Sides tombstones	 Cubi a croce Cross cubes	 Squadre Angles
PIASTRE E PALLET PLATES AND PALLET					 Piastre e sovratavole Plates & Interfaced plates	 Pallet macchina Machine pallet
POSSIBILITÀ DI POSSIBILITY OF			 Posizionamento & cambio rapido Quick change & positioning	 Cubi-morsa Vise tower	 Divisore Automatico Automatic dividing head	 Divisore Meccanico Mechanical dividing head
PAGINE PAGES					 Accessori & Ricambi Accessories & Spare Parts	 Istruzioni corretto utilizzo Instruction for a proper use