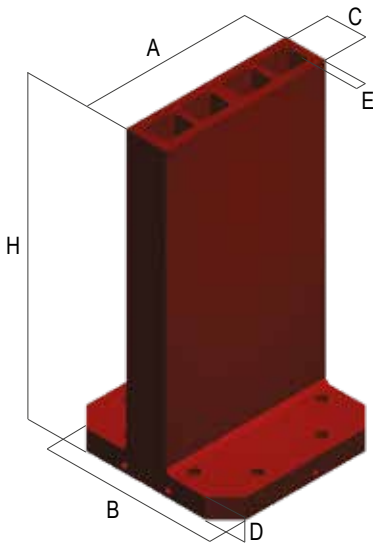

**SPALLE LEGGERE - 2 SIDES TOMBSTONES LIGHT**
**NEW**
**Art. 55A1**

General tolerance +12 +8 mm

**Dimensioni - Dimensions**

A	B	C	D	E	H	kg	Cod.
410	410	110	60	25	760	204	8.55.A10045
410	410	160	60	25	860	250	8.55.A10050
510	510	160	60	25	760	292	8.55.A10053
510	510	210	60	30	910	436	8.55.A10085
640	640	210	60	30	960	574	8.55.A10172
640	640	260	60	35	960	666	8.55.A10175

E= Spessore pareti - Wall tickness

**Art. 55B1**

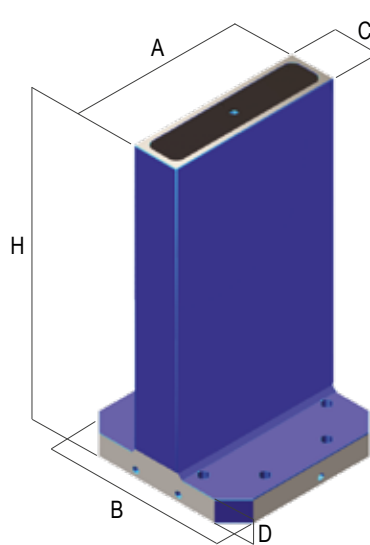
 Base finita  
 Base finished

General tolerance +12 +8 mm

**Dimensioni - Dimensions**

A	B	C	D	E	H	kg	Cod.
400	400	110	55	25	750	193	8.55.B10045
400	400	160	55	25	850	239	8.55.B10050
500	500	160	55	25	750	277	8.55.B10053
500	500	210	55	30	900	402	8.55.B10085
630	630	210	55	30	950	553	8.55.B10172
630	630	260	55	35	950	645	8.55.B10175

E= Spessore pareti - Wall tickness

**Art. 55C1\***

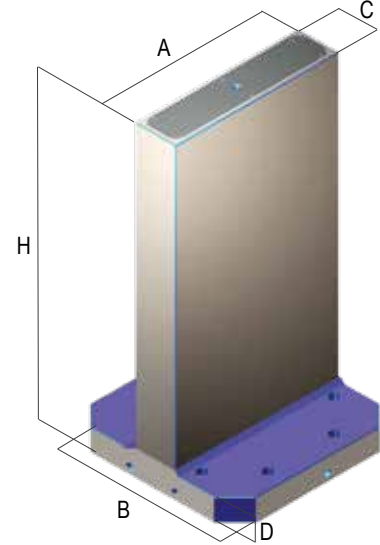
 Completamente lavorati  
 Completely machined

General tolerance ± 0,02 mm

**Dimensioni - Dimensions**

A	B	C	D	E	H	kg	Cod.
400	400	100	50	20	750	163	8.55.C10045
400	400	150	50	20	850	203	8.55.C10050
500	500	150	50	20	750	238	8.55.C10053
500	500	200	50	25	900	371	8.55.C10085
630	630	200	50	25	950	489	8.55.C10172
630	630	250	50	30	950	579	8.55.C10175

E= Spessore pareti - Wall tickness

**Specifiche - Specifications**
**Art. 55A1**

Fusione in ghisa G30 monoblocco con doppio trattamento di distensione.

**Pareti con spessore ridotto**  
 (Sovrametallo 15 mm).

One integral G30 cast iron casting with double stress relieving heat treatment.

**Wall with reduced thickness**  
 (15 mm stock)

**Art. 55B1**

 Fusione con base lavorata e raschiata per pallet a norme Europee o Giapponesi.  
**Vedi specifiche a pag. 8.6**

 Casting with base face machined and hand scraped for direct clamping on European or Japanese standard pallet.  
**See specifications pag. 8.6**
**Art. 55C1**

 Cubo completamente finito con **pareti di spessore ridotto**

 Cube completely finished with **wall reduced thickness**

 Predisposizione, montaggio ed allineamento di ogni morsa €204  
 Set-up, mounting and alignment for each vise

Available also as wall thickness 38-40mm (Pag.8.8 - 8.9)

! For different finishing and materials (aluminium), ask for specific quotation

## Portapezzi

# TOMBSTONES

**Cubi, spalle, squadre, piastre, pallets**

*Cubes, 2 sides tombstones, Angle plates, plates*



Precisione / Accuracy  
 $\pm 0,005\text{mm}$



Durezza / Hardened  
**HRC 58 $\pm$ 2**

### QUALITÀ GERARDI

- 1 - FUSIONE MONOBLOCCO IN GHISA G30
- 2 - DOPPIO TRATTAMENTO TERMICO DI DISTENSIONE
- 3 - LAVORAZIONE COMPLETA DI FRESATURA E PREDISPOSIZIONE PER NOSTRO SISTEMA ZERO POINT
- 4 - DISTENSIONE NATURALE DI RIPOSO MINIMO 48 ORE
- 5 - RASCHIETTATURA BASE D'APPOGGIO PER UNA PLANARITA' PERFETTA
- 6 - LAVORAZIONE COMPLETA DI FINITURA
- 7 - ESECUZIONE DI FORI O CAVE DI POSIZIONAMENTO E CENTRAGGIO PORTAPEZZO SULLA BASE D'APPOGGIO RASCHIETTATA
- 8 - CONTROLLO DIMENSIONALE PORTAPEZZO
- 9 - EVENTUALE RITOCOCCO TRAMITE RASCHIETTATURA PER RIPORTARE IL PORTAPEZZO NELLA PERPENDICOLARITA', ORTOGONALITA' E PARALLELISMO PREVISTI
- 10 - IDENTIFICAZIONE TRAMITE NUMERO DI MATRICOLA INCISO SUL PORTAPEZZO CON ALLEGATO CERTIFICATO DI COLLAUDO

### GERARDI QUALITY

- 1 - INTEGRAL CAST IRON G30 CASTING
- 2 - DOUBLE STRESS RELIEVING HEAT TREATMENT
- 3 - COMPLETE ROUGH MILLING WORK AND PREARRANGED WORK FOR THE USE OF OUR ZERO POINT GERARDI SYSTEM
- 4 - NATURAL 48 HOURS STRESS RELIEVING
- 5 - HAND SCRAPING OF BOTTOM BASE FACE FOR A PERFECT PLANARITY
- 6 - COMPLETE MACHINE FINISHING
- 7 - BASE FACE TAILOR-MADE, TOMBSTONE CENTERED ON THE HAND SCRAPE BASE PLATE
- 8 - DIMENSIONAL CONTROL AND QUALITY CHECK
- 9 - SOME HAND-SCRAPED COULD BE MADE IN ORDER TO GET A PERFECT - PARALLELISM - ORTOGONALITY AND PERPENDICULARITY WITHIN THE QUOTED TOLERANCES.
- 10 - PART IDENTIFICATION ENGRAVED ON THE PRODUCT WITH INSPECTION SHEET INCLUDED.



### Soluzioni Speciali

#### Specific Tombstones

Soluzioni speciali e personalizzate integrate con sistemi di bloccaggio adeguati possono essere studiate e realizzate su richiesta per sfruttare al meglio il campo di lavoro e le capacità delle macchine.

Specific or tailor-made tombstones complete with clamping systems applications could be studied and manufactured on request in order to better exploit the machines runs and capacity



Cubo a croce  
 Cross cube

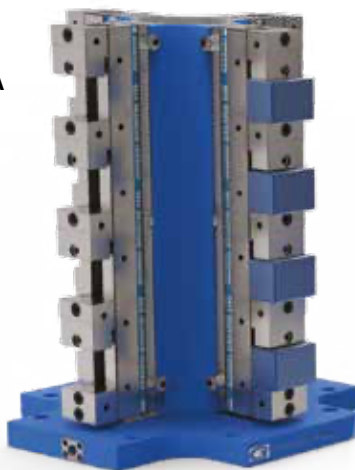

Cubo a reticolo  
 Grid Cube

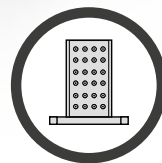

### Predisposizione Zero Point

#### Zero Point Ready

Predisposizione della base di appoggio di 4 fori Ø20F7 e filetto M16 con interassi precisi, pronte per l'utilizzo dei ns. Zero point, oppure per l'interfacciamento con altri pallett o piastre.

Base with 4 precision holes Ø 20F7 and bottom threads M16 with precise pitch dimensions for the use of our Zero Point or to be interfaced with other pallets or head plates

A supporto ed integrazione dei sistemi di bloccaggio la GERARDI ha progettato e via via sviluppato una gamma di portapezzi in fusioni monoblocco di ghisa G30 (con pareti spessore 43-45mm circa e con doppio trattamento di distensione e stabilizzazione) e recentemente anche di alluminio speciale ad alta resistenza. Tali prodotti possono essere forniti nelle forme di: Cubi, Spalle, Squadre, Piastre, Mensole e speciali a richiesta. L'importanza sempre maggiore di questi prodotti deriva dallo sviluppo e diffusione di centri di lavoro orizzontali e sistemi pallettizzati che richiedono appunto tali strutture di supporto per le attrezzature o per i pezzi da lavorare stessi. I controlli vengono eseguiti con macchine tridimensionali su ogni pezzo eseguito.

To support and complete the Gerardi Modular Workholding System a more and more strategic and important role is played by all the range of modular tombstones and sub-plates. They are manufactured in the most different shapes and versions, anyway always provided in one solid cast iron cast G30 with walls about 40 mm thickness and with double stress relieving heat treatment. Recently in high resistance aluminum. The shapes available are: Cubes, Two side tombstone, Angles, Plates and subplates, Shelves and special on specific request. The greater importance of such products originates from the development and widespread of Horizontal machining centres and multipallet systems which require just such structures to support the fixtures or work-pieces. The checking is carried out piece by piece on a 3-dimensional machine.

**Cubo leggero**  
 Light Cube

Nuova serie di cubi ALLEGGERITA con pareti di spessore 20/25mm ideali per centri di lavoro ad alta velocità  
 New cubes light series with wall reduced thickness 20/25mm ideal for high speed machine

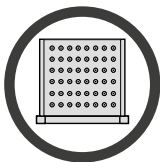
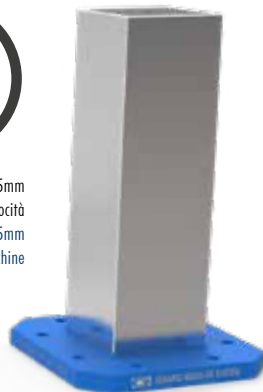
**Spalla a reticolo**  
 2 side tombstone

Qualsiasi modifica, lavorazione o personalizzazione extra sarà eseguita previo preventivo. Per le versioni speciali pagamento 50% all'ordine. Il ns. ufficio tecnico è a Vs. disposizione per eventuali chiarimenti e consegne

Any special requirement will be quoted "Extra" for special type payment 50% on order. Our technical department is always available for any explanations or delivery time

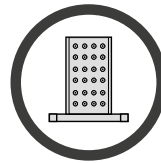
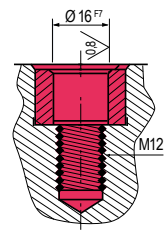
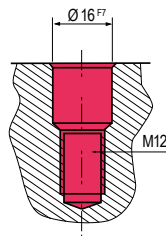

## Per centri di lavoro orizzontali

## For horizontal machining centre

**DISPONIBILI IN 5 VERSIONI DIVERSE**  
**AVAILABLE IN 5 DIFFERENT FINISHING**

**Versione A - Type A**
**FUSIONE IN GHISA - CAST IRON CASTING**

Fusione in ghisa G30 monoblocco con doppio trattamento di distensione. Pareti spessore 43-45 mm (Sovrametallo 10 mm)  
 \*Alcuni modelli indicati non vengono sgrassati

One integral G30 cast iron casting with double stress relieving heat treatment. Wall thickness 43-45 mm (10 mm stock)  
 \*Few highlighted items are not rough milled

**Versione B - Type B**
**BASE FINITA - BASE FINISHED**

Fusione con base lavorata e raschiata per pallet a norme Europee o Giapponesi.

Casting with base face machined and hand scraped for direct clamping on European or Japanese standard pallet.

**Versione C - Type C**
**COMPLETAMENTE LAVORATI - COMPLETELY FINISHED**

Cubo completamente finito con pareti spessore 38-40 mm circa. Tolleranza  $\pm 0,02$  mm

Cube completely finished with wall thickness roughly 38-40 mm. Tolerance  $\pm 0,02$  mm

**Versione E - Type E**
**RETICOLO INTEGRALE - GRIND CUBE**

Cubo a reticolo con fori calibrati e filetti integrali nella fusione. Tolleranza  $\pm 0,02$  mm

Integral cube with calibrated holes and solid threads in the casting itself. Tolerance  $\pm 0,02$  mm

**Versione F - Type F**
**RETICOLO CON BUSSOLE - GRID CUBE WITH BUSHINGS**

Cubo a reticolo con bussole di centraggio in acciaio temprato 100 Cr6 - DIN 179C. Filetti riportati in acciaio inox 18/8. Tolleranza  $\pm 0,02$  mm

Integral cube with centering bushings in special hardened alloy steel 100Cr6 - DIN 179C. Inserted threads are in 18/8 stainless steel. Tolerance  $\pm 0,02$  mm

# INTERFACCIAMENTO STANDARD

## STANDARD INTERFACE

### STANDARD EUROPEO EUROPEAN STANDARD

A	400	500	630	800
B	-	-	-	-
C	80	100	125	160
B	-	-	-	-

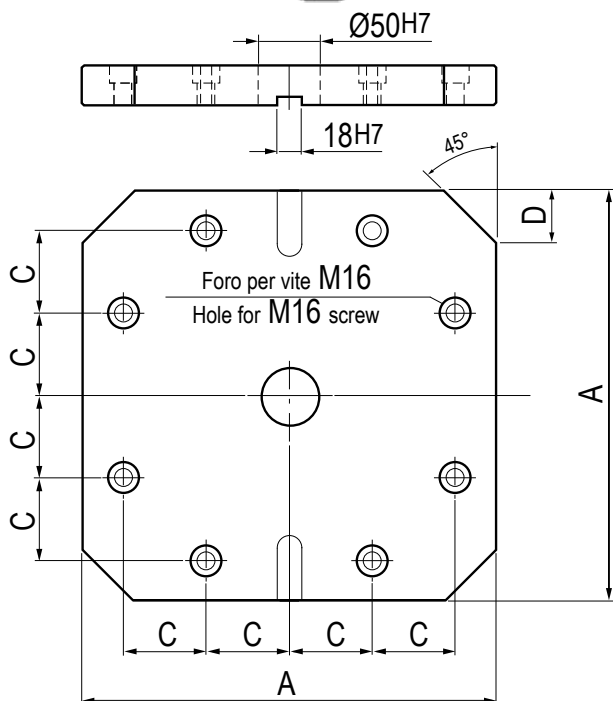

### STANDARD GIAPPONESE (Normativa JIS) JAPANESE STANDARD (Normative JIS)

A	400	500	630	800
B	55	75	100	135
C	80	100	125	160
B	55	75	100	135

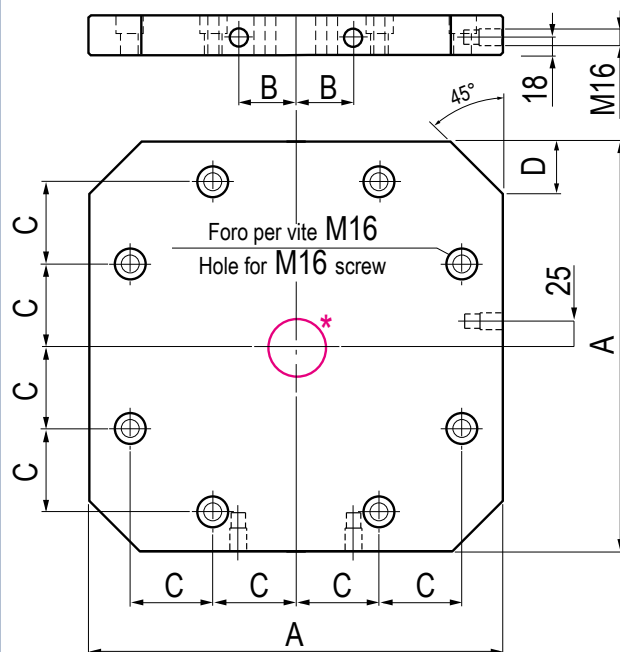

Foro centrale (OPZIONE)\* - Central hole (OPTIONAL)\*

# COME LAVORARE I PORTAPEZZI, TRAMITE ZERO POINT E STAFFE INTELLIGENTI

## HOW TO MACHINE TOMBSTONES WITH ZERO POINT AND INTELLIGENT CLAMPS

Tutti i ns. portapezzi (escluso la fusione grezza), sono predisposti, sulla base di appoggio con forature e filettature per l'uso dei tiranti

Zero-Point Art.11A T.2 Questo principalmente significa che tutti i ns. portapezzi possono essere velocemente fissati, posizionati e lavorati sulle 5 facce senza nessun impedimento per quanto riguarda il percorso utensili.

All our tombstone fixture (rough cast iron casting excluded) are pre-worked and prepared on the bottom base face for our Zero-Point pull-stud Art.11A T.2. This important feature will give you many possible application.

**Fig.1**  
**Pic.1**

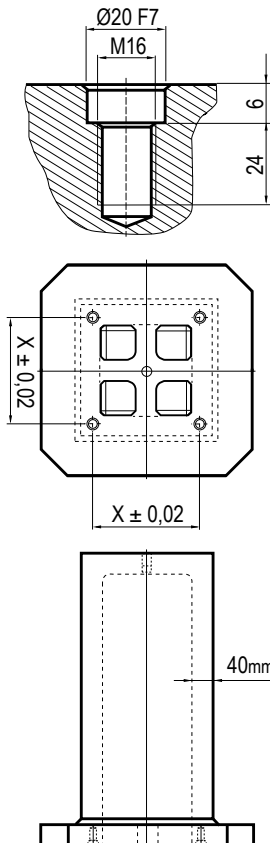

\* Sulle superfici grezze aggiungere 5mm  
 \* Add 5mm on the rough surfaces

**Fig.2**  
**Pic.2**

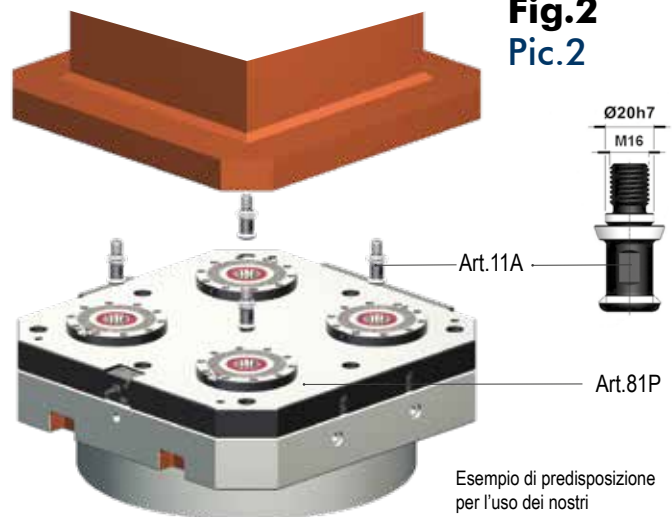

Esempio di predisposizione per l'uso dei nostri "Zero Point System"  
 Prearranged work for the use of our "Zero Point System"

Per montaggio, posizionamento e ancoraggio istantaneo con necessità di collegamento pneumatico solo per lo sbloccaggio. Il bloccaggio è meccanico tramite molle. Con questo sistema il pallet può tranquillamente essere movimentato senza l'ausilio di collegamenti elettrici, elettronici, idraulici o pneumatici.

Quick clamping and accurate positioning set up of your tombstone through pneumatic source (only for unclamping - clamping is mechanically maintained by springs)  
 With this system your pallet could easily travel without the need of electrical pneumatic or electronic connection.

**Fig.3**  
**Pic.3**

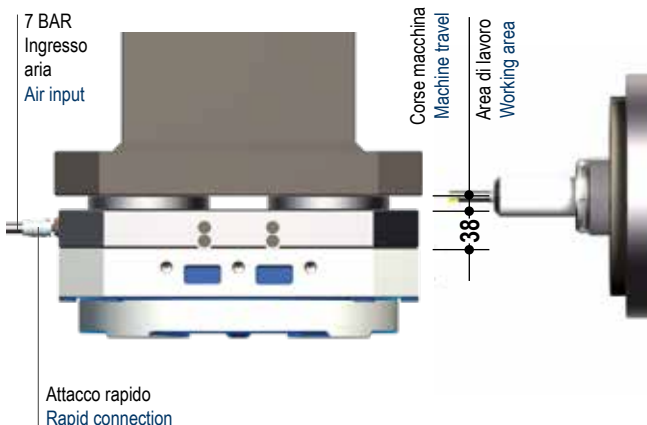

Gli "Zero Point Gerardi" sono utilizzabili anche per ottimizzare le corse del Vs. centro orizzontale sollevando il pezzo all'altezza desiderata senza l'ausilio di sovravole.

Our hydraulic or pneumatic "Zero Point Gerardi" are also used to optimize the vertical travel of your horizontal machining center without the need of extra over pallet plates.

**Fig.4**  
**Pic.4**

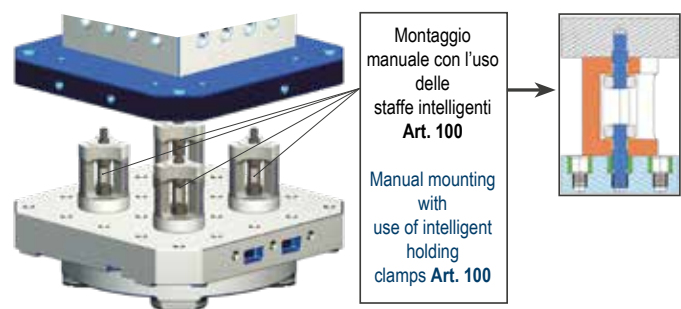

Montaggio manuale con l'uso delle staffe intelligenti Art. 100  
 Manual mounting with use of intelligent holding clamps Art. 100

I fori di predisposizione (Fig.1- pag. 8.5) possono essere usati anche per l'utilizzo di "staffe intelligenti" Art.100 e relativi prigionieri.

The pre-work holes (Pic.1- pag. 8.5) are also coming handy for the use of our "intelligent clamps" Art. 100

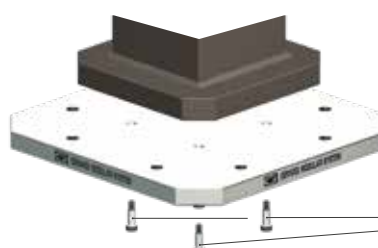

Inoltre con questo sistema di predisposizione potete fissare una piastra che vi permette l'interfacciamento sulla Vs. macchina o attrezzatura. (Fig.1)

Further more with this solution you can fix any plate you wish to adapt as you need (Pic.1)

Art. 100



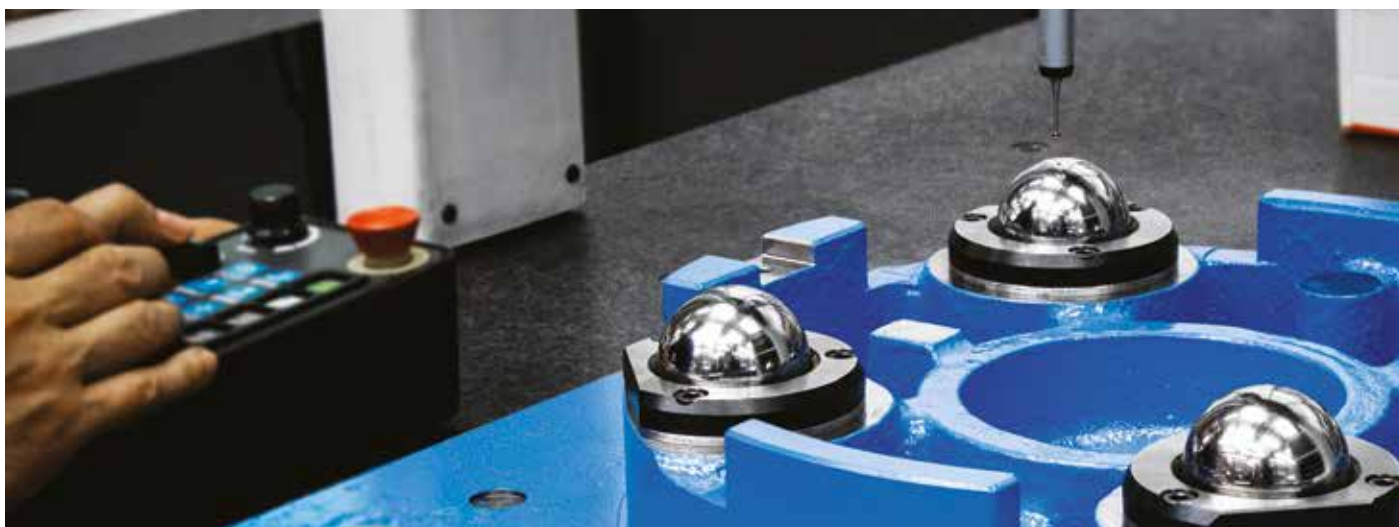

# VERIFICHE DIMENSIONALI TRAMITE MACCHINE DI MISURA

## DIMENSIONAL CHECK THROUGH MEASUREMENT MACHINES

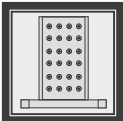
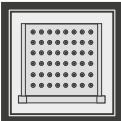

### SIMBOLOGIA DATI TECNICI

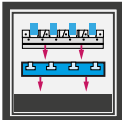
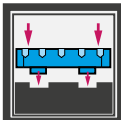
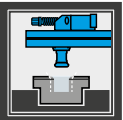
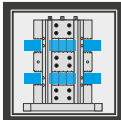
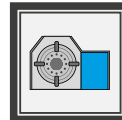
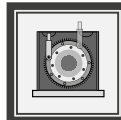
### TECHNICAL DATA ICONS

<b>MODELLI PORTAPEZZI</b> <b>TOMBSTONE MODELS</b>			 Cubi Cubes	 Spalle 2 Sides tombstones	 Cubi a croce Cross cubes	 Squadre Angles
<b>PIASTRE E PALLET</b> <b>PLATES AND PALLET</b>					 Piastre e sovratavole Plates & Interfaced plates	 Pallet macchina Machine pallet
<b>POSSIBILITÀ DI</b> <b>POSSIBILITY OF</b>			 Posizionamento & cambio rapido Quick change & positioning	 Cubi-morsa Vise tower	 Divisore Automatico Automatic dividing head	 Divisore Meccanico Mechanical dividing head
<b>PAGINE</b> <b>PAGES</b>					 Accessori & Ricambi Accessories & Spare Parts	 Istruzioni corretto utilizzo Instruction for a proper use