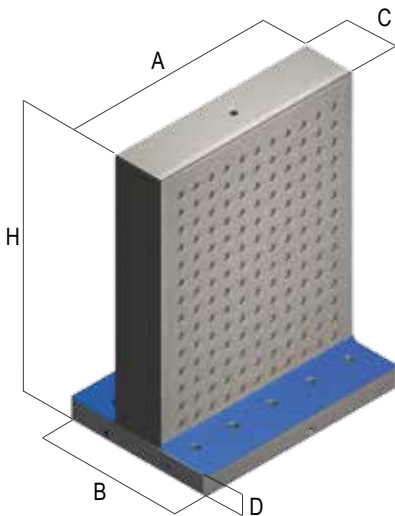
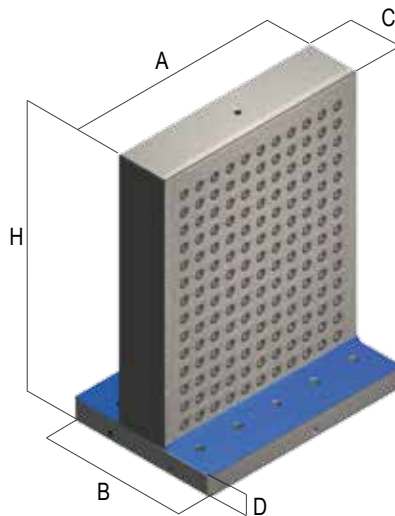

SPALLE - 2 SIDES TOMBSTONES
Art. 55E

 Reticolo integrale
 Grid tombstone

Art. 55F

 Reticolo con bussole
 Grid tombstone with bushing

 Stesse dimensioni dell'Art. 55C / Same dimensions of Art. 55C
 Peso: -5% circa rispetto Art. 55C / Weight: About -5% of Art. 55C

Specifiche - Specifications
Art. 55A

 Fusione in ghisa G30 monoblocco con doppio trattamento di distensione.
 Pareti con spessore 48-50 mm
 (Sovrametallo 15 mm)

 One integral G30 cast iron casting with double stress relieving heat treatment.
 Wall thickness 48-50 mm
 (15 mm stock)

Art. 55B

 Fusione con base lavorata e raschiata per pallet a norme Europee o Giapponesi.
Vedi specifiche a pag. 8.6

 Casting with base face machined and hand scraped for direct clamping on
 European or Japanese standard pallet.
See specifications pag. 8.6
Art. 55C

Spalla completamente finito con pareti spessore 38-40 mm circa.

2 sides tombstone completely finished with wall thickness roughly 38-40 mm

 Predisposizione, montaggio ed allineamento di ogni morsa
Set-up, mounting and alignment for each vise
Art. 55E 40 / 50

 Spalla a reticolo con fori calibrati e filettati integrali - Tolleranza $\pm 0,02$ mm

- Interasse reticolo 40 mm = $\varnothing 12 / M10$
- Interasse reticolo 50 mm = $\varnothing 16 / M12$

 2 sides grid tombstone with calibrated holes and solid threads - Tolerance $\pm 0,02$ mm

- Grid pitch 40 mm = $\varnothing 12 / M10$
- Grid pitch 50 mm = $\varnothing 16 / M12$

 Montaggio ed allineamento di ogni morsa
Mounting and alignment for each vise
Art. 55F 40 / 50

 Spalla a reticolo con bussole temprate 100Cr6 e filetti riportati in acciaio inox
 Tolleranza $\pm 0,02$ mm

- Interasse reticolo 40 mm = $\varnothing 12 / M10$
- Interasse reticolo 50 mm = $\varnothing 16 / M12$

2 sides grid tombstone with hardened bushing 100Cr6 and stainless steel helicoils

- Tolleranza $\pm 0,02$ mm
- Grid pitch 40 mm = $\varnothing 12 / M10$
- Grid pitch 50 mm = $\varnothing 16 / M12$

 Montaggio ed allineamento di ogni morsa
Mounting and alignment for each vise

 Disponibili in versione leggera (Pag.8.10 - 8.11)
 Available also as light version (Pag.8.10 - 8.11)

Art. 55E 40		Art. 55E 50		Art. 55F 40		Art. 55F 50	
Cod.		Cod.		Cod.		Cod.	
8.55.E40010		8.55.E00010		8.55.F40010		8.55.F00010	
8.55.E40040		8.55.E00040		8.55.F40040		8.55.F00040	
8.55.E40044		8.55.E00044		8.55.F40044		8.55.F00044	
8.55E40045		8.55E00045		8.55F40045		8.55F00045	
8.55.E40050		8.55.E00050		8.55.F40050		8.55.F00050	
8.55.E40051		8.55.E00051		8.55.F40051		8.55.F00051	
8.55.E40052		8.55.E00052		8.55.F40052		8.55.F00052	
8.55.E40053		8.55.E00053		8.55.F40053		8.55.F00053	
8.55.E40054		8.55.E00054		8.55.F40054		8.55.F00054	
8.55.E40055		8.55.E00055		8.55.F40055		8.55.F00055	
8.55.E40060		8.55.E00060		8.55.F40060		8.55.F00060	
8.55.E40070		8.55.E00070		8.55.F40070		8.55.F00070	
8.55.E40080		8.55.E00080		8.55.F40080		8.55.F00080	
8.55.E40090		8.55.E00090		8.55.F40090		8.55.F00090	
8.55.E40120		8.55.E00120		8.55.F40120		8.55.F00120	
8.55.E40125		8.55.E00125		8.55.F40125		8.55.F00125	
8.55.E40150		8.55.E00150		8.55.F40150		8.55.F00150	
8.55.E40160		8.55.E00160		8.55.F40160		8.55.F00160	
8.55.E40170		8.55.E00170		8.55.F40170		8.55.F00170	
8.55.E40171		8.55.E00171		8.55.F40171		8.55.F00171	
8.55.E40172		8.55.E00172		8.55.F40172		8.55.F00172	
8.55.E40173		8.55.E00173		8.55.F40173		8.55.F00173	
8.55.E40180		8.55.E00180		8.55.F40180		8.55.F00180	
8.55.E40190		8.55.E00190		8.55.F40190		8.55.F00190	
8.55.E40191		8.55.E00191		8.55.F40191		8.55.F00191	
8.55.E40192		8.55.E00192		8.55.F40192		8.55.F00192	
8.55.E40230		8.55.E00230		8.55.F40230		8.55.F00230	
8.55.E40235		8.55.E00235		8.55.F40235		8.55.F00235	

Usually available immediately

! For different finishing and materials (aluminium), ask for specific quotation

Portapezzi

TOMBSTONES

Cubi, spalle, squadre, piastre, pallets

Cubes, 2 sides tombstones, Angle plates, plates



Precisione / Accuracy
 $\pm 0,005\text{mm}$



Durezza / Hardened
HRC 58 \pm 2

QUALITÀ GERARDI

- 1 - FUSIONE MONOBLOCCO IN GHISA G30
- 2 - DOPPIO TRATTAMENTO TERMICO DI DISTENSIONE
- 3 - LAVORAZIONE COMPLETA DI FRESATURA E PREDISPOSIZIONE PER NOSTRO SISTEMA ZERO POINT
- 4 - DISTENSIONE NATURALE DI RIPOSO MINIMO 48 ORE
- 5 - RASCHIETTATURA BASE D'APPOGGIO PER UNA PLANARITA' PERFETTA
- 6 - LAVORAZIONE COMPLETA DI FINITURA
- 7 - ESECUZIONE DI FORI O CAVE DI POSIZIONAMENTO E CENTRAGGIO PORTAPEZZO SULLA BASE D'APPOGGIO RASCHIETTATA
- 8 - CONTROLLO DIMENSIONALE PORTAPEZZO
- 9 - EVENTUALE RITOCOCCO TRAMITE RASCHIETTATURA PER RIPORTARE IL PORTAPEZZO NELLA PERPENDICOLARITA', ORTOGONALITA' E PARALLELISMO PREVISTI
- 10 - IDENTIFICAZIONE TRAMITE NUMERO DI MATRICOLA INCISO SUL PORTAPEZZO CON ALLEGATO CERTIFICATO DI COLLAUDO

GERARDI QUALITY

- 1 - INTEGRAL CAST IRON G30 CASTING
- 2 - DOUBLE STRESS RELIEVING HEAT TREATMENT
- 3 - COMPLETE ROUGH MILLING WORK AND PREARRANGED WORK FOR THE USE OF OUR ZERO POINT GERARDI SYSTEM
- 4 - NATURAL 48 HOURS STRESS RELIEVING
- 5 - HAND SCRAPING OF BOTTOM BASE FACE FOR A PERFECT PLANARITY
- 6 - COMPLETE MACHINE FINISHING
- 7 - BASE FACE TAILOR-MADE, TOMBSTONE CENTERED ON THE HAND SCRAPE BASE PLATE
- 8 - DIMENSIONAL CONTROL AND QUALITY CHECK
- 9 - SOME HAND-SCRAPED COULD BE MADE IN ORDER TO GET A PERFECT - PARALLELISM - ORTOGONALITY AND PERPENDICULARITY WITHIN THE QUOTED TOLERANCES.
- 10 - PART IDENTIFICATION ENGRAVED ON THE PRODUCT WITH INSPECTION SHEET INCLUDED.



Soluzioni Speciali

Specific Tombstones

Soluzioni speciali e personalizzate integrate con sistemi di bloccaggio adeguati possono essere studiate e realizzate su richiesta per sfruttare al meglio il campo di lavoro e le capacità delle macchine.

Specific or tailor-made tombstones complete with clamping systems applications could be studied and manufactured on request in order to better exploit the machines runs and capacity



Cubo a croce
 Cross cube

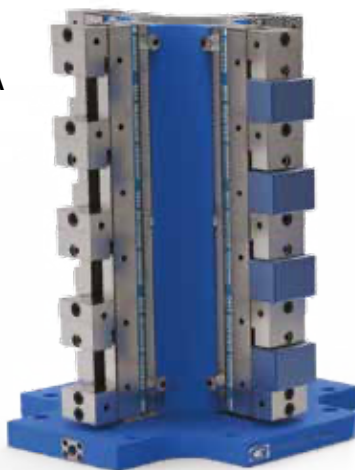

Cubo a reticolo
 Grid Cube

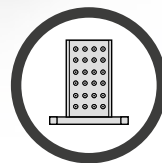

Predisposizione Zero Point

Zero Point Ready

Predisposizione della base di appoggio di 4 fori Ø20F7 e filetto M16 con interassi precisi, pronte per l'utilizzo dei ns. Zero point, oppure per l'interfacciamento con altri pallett o piastre.

Base with 4 precision holes Ø 20F7 and bottom threads M16 with precise pitch dimensions for the use of our Zero Point or to be interfaced with other pallets or head plates

A supporto ed integrazione dei sistemi di bloccaggio la GERARDI ha progettato e via via sviluppato una gamma di portapezzi in fusioni monoblocco di ghisa G30 (con pareti spessore 43-45mm circa e con doppio trattamento di distensione e stabilizzazione) e recentemente anche di alluminio speciale ad alta resistenza. Tali prodotti possono essere forniti nelle forme di: Cubi, Spalle, Squadre, Piastre, Mensole e speciali a richiesta. L'importanza sempre maggiore di questi prodotti deriva dallo sviluppo e diffusione di centri di lavoro orizzontali e sistemi pallettizzati che richiedono appunto tali strutture di supporto per le attrezzature o per i pezzi da lavorare stessi. I controlli vengono eseguiti con macchine tridimensionali su ogni pezzo eseguito.

To support and complete the Gerardi Modular Workholding System a more and more strategic and important role is played by all the range of modular tombstones and sub-plates. They are manufactured in the most different shapes and versions, anyway always provided in one solid cast iron cast G30 with walls about 40 mm thickness and with double stress relieving heat treatment. Recently in high resistance aluminum. The shapes available are: Cubes, Two side tombstone, Angles, Plates and subplates, Shelves and special on specific request. The greater importance of such products originates from the development and widespread of Horizontal machining centres and multipallet systems which require just such structures to support the fixtures or work-pieces. The checking is carried out piece by piece on a 3-dimensional machine.

Cubo leggero
 Light Cube

Nuova serie di cubi ALLEGGERITA con pareti di spessore 20/25mm ideali per centri di lavoro ad alta velocità
 New cubes light series with wall reduced thickness 20/25mm ideal for high speed machine

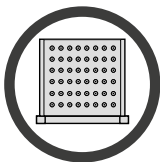
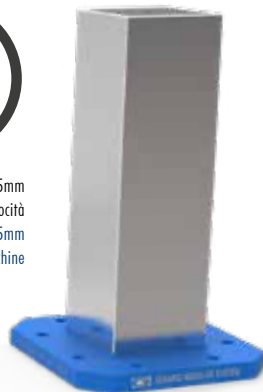
Spalla a reticolo
 2 side tombstone

Qualsiasi modifica, lavorazione o personalizzazione extra sarà eseguita previo preventivo. Per le versioni speciali pagamento 50% all'ordine. Il ns. ufficio tecnico è a Vs. disposizione per eventuali chiarimenti e consegne

Any special requirement will be quoted "Extra" for special type payment 50% on order. Our technical department is always available for any explanations or delivery time

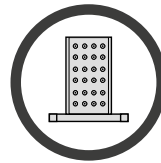

Per centri di lavoro orizzontali

For horizontal machining centre

DISPONIBILI IN 5 VERSIONI DIVERSE
AVAILABLE IN 5 DIFFERENT FINISHING

Versione A - Type A
FUSIONE IN GHISA - CAST IRON CASTING

Fusione in ghisa G30 monoblocco con doppio trattamento di distensione. Pareti spessore 43-45 mm (Sovrametallo 10 mm)
 *Alcuni modelli indicati non vengono sgrassati

One integral G30 cast iron casting with double stress relieving heat treatment. Wall thickness 43-45 mm (10 mm stock)
 *Few highlighted items are not rough milled

Versione B - Type B
BASE FINITA - BASE FINISHED

Fusione con base lavorata e raschiata per pallet a norme Europee o Giapponesi.

Casting with base face machined and hand scraped for direct clamping on European or Japanese standard pallet.

Versione C - Type C
COMPLETAMENTE LAVORATI - COMPLETELY FINISHED

Cubo completamente finito con pareti spessore 38-40 mm circa. Tolleranza $\pm 0,02$ mm

Cube completely finished with wall thickness roughly 38-40 mm. Tolerance $\pm 0,02$ mm

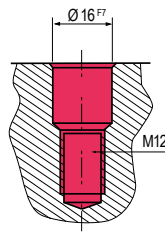
Versione E - Type E
RETICOLO INTEGRALE - GRIND CUBE

Cubo a reticolo con fori calibrati e filetti integrali nella fusione. Tolleranza $\pm 0,02$ mm

Integral cube with calibrated holes and solid threads in the casting itself. Tolerance $\pm 0,02$ mm

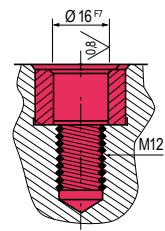
Versione F - Type F
RETICOLO CON BUSSOLE - GRID CUBE WITH BUSHINGS

Cubo a reticolo con bussole di centraggio in acciaio temprato 100 Cr6 - DIN 179C. Filetti riportati in acciaio inox 18/8. Tolleranza $\pm 0,02$ mm

Integral cube with centering bushings in special hardened alloy steel 100Cr6 - DIN 179C. Inserted threads are in 18/8 stainless steel. Tolerance $\pm 0,02$ mm

INTERFACCIAMENTO STANDARD

STANDARD INTERFACE

STANDARD EUROPEO EUROPEAN STANDARD

A	400	500	630	800
B	-	-	-	-
C	80	100	125	160
B	-	-	-	-

STANDARD GIAPPONESE (Normativa JIS) JAPANESE STANDARD (Normative JIS)

A	400	500	630	800
B	55	75	100	135
C	80	100	125	160
B	55	75	100	135

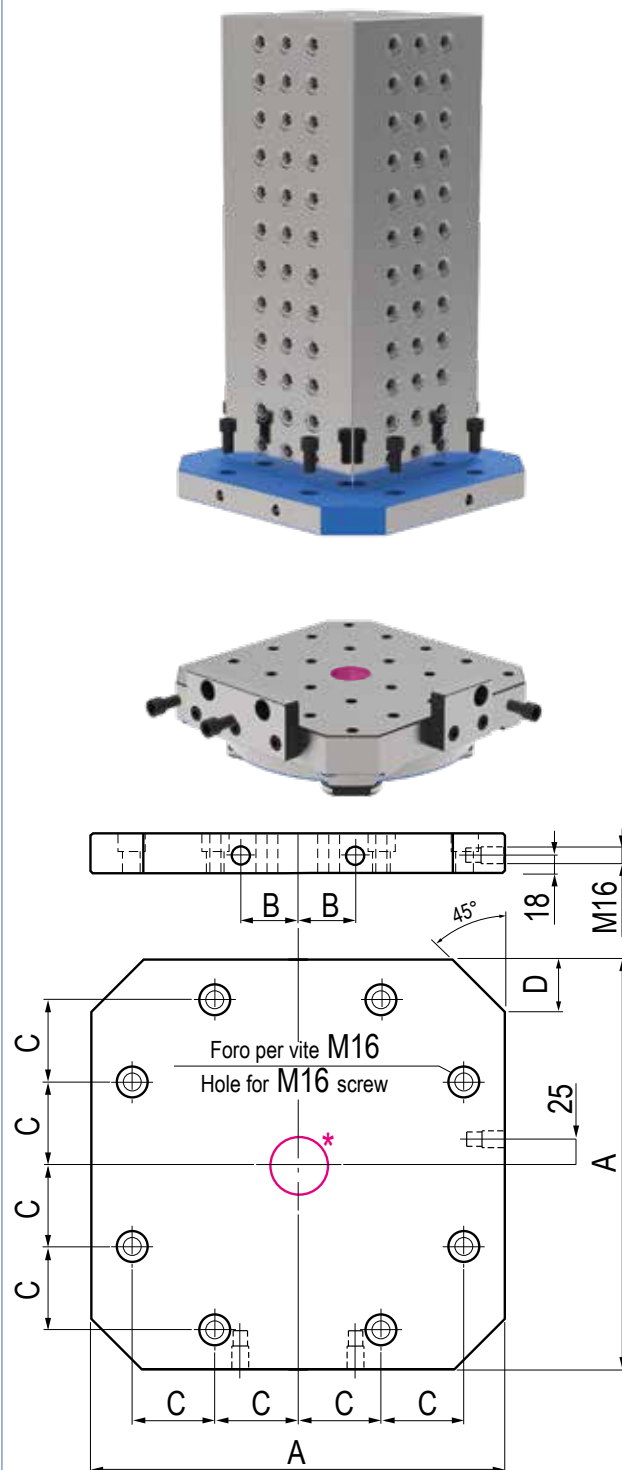
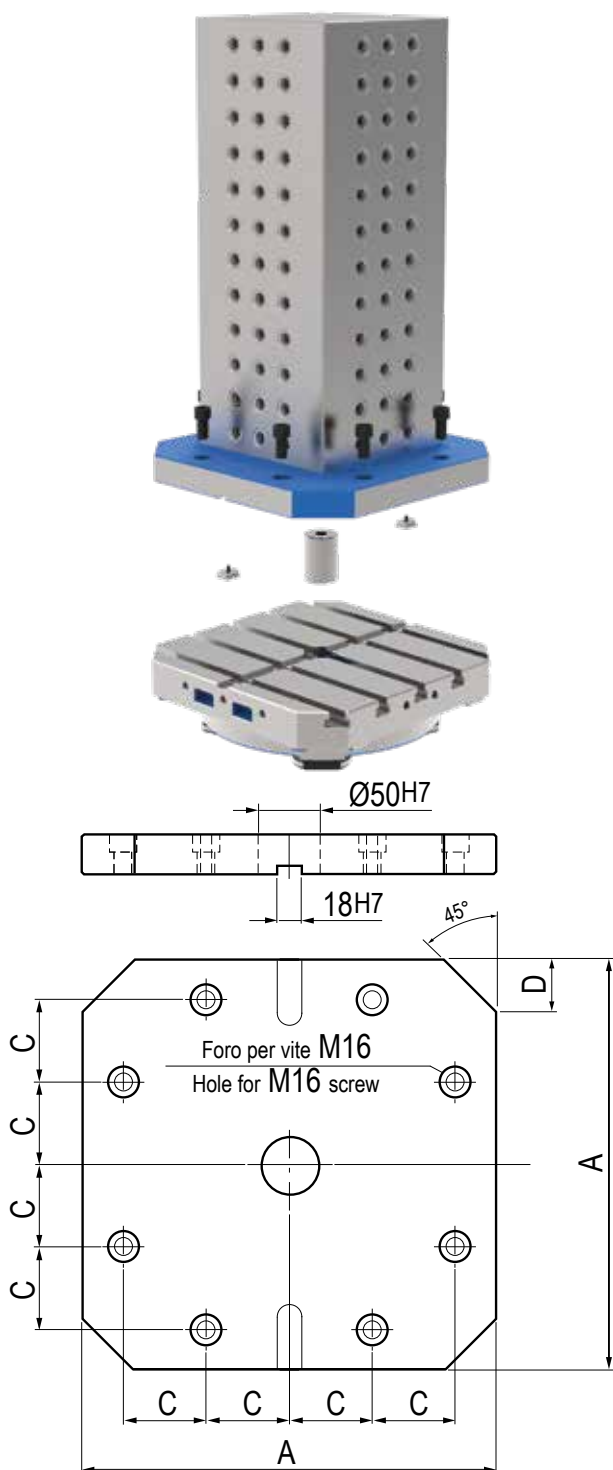

Foro centrale (OPZIONE)* - Central hole (OPTIONAL)*

COME LAVORARE I PORTAPEZZI, TRAMITE ZERO POINT E STAFFE INTELLIGENTI

HOW TO MACHINE TOMBSTONES WITH ZERO POINT AND INTELLIGENT CLAMPS

Tutti i ns. portapezzi (escluso la fusione grezza), sono predisposti, sulla base di appoggio con forature e filettature per l'uso dei tiranti

Zero-Point Art.11A T.2 Questo principalmente significa che tutti i ns. portapezzi possono essere velocemente fissati, posizionati e lavorati sulle 5 facce senza nessun impedimento per quanto riguarda il percorso utensili.

All our tombstone fixture (rough cast iron casting excluded) are pre-worked and prepared on the bottom base face for our Zero-Point pull-stud Art.11A T.2. This important feature will give you many possible application.

Fig.1
Pic.1

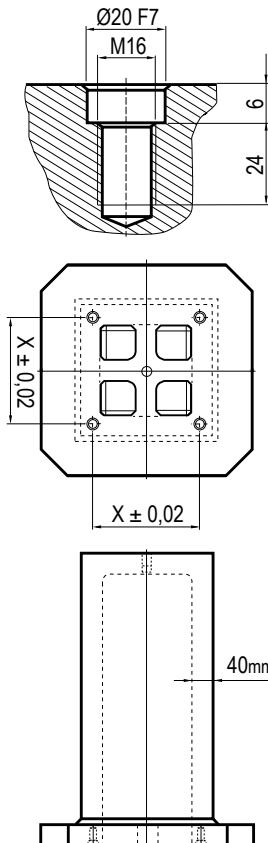

* Sulle superfici grezze aggiungere 5mm
 * Add 5mm on the rough surfaces

Fig.2
Pic.2

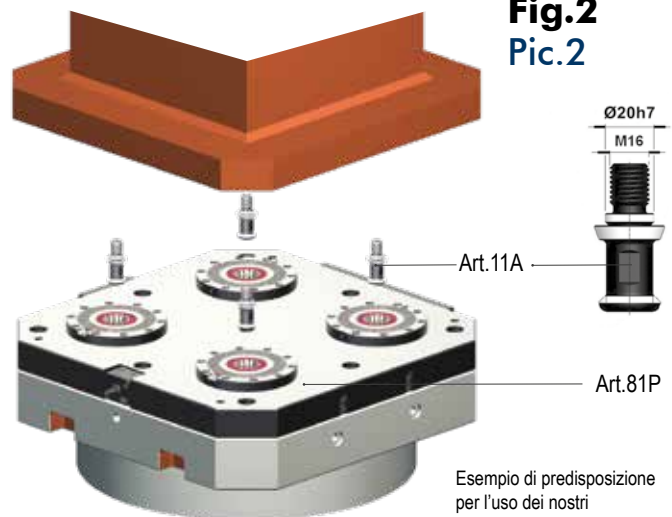

Esempio di predisposizione per l'uso dei nostri "Zero Point System"
 Prearranged work for the use of our "Zero Point System"

Per montaggio, posizionamento e ancoraggio istantaneo con necessità di collegamento pneumatico solo per lo sbloccaggio. Il bloccaggio è meccanico tramite molle. Con questo sistema il pallet può tranquillamente essere movimentato senza l'ausilio di collegamenti elettrici, elettronici, idraulici o pneumatici.

Quick clamping and accurate positioning set up of your tombstone through pneumatic source (only for unclamping - clamping is mechanically maintained by springs)
 With this system your pallet could easily travel without the need of electrical pneumatic or electronic connection.

Fig.3
Pic.3

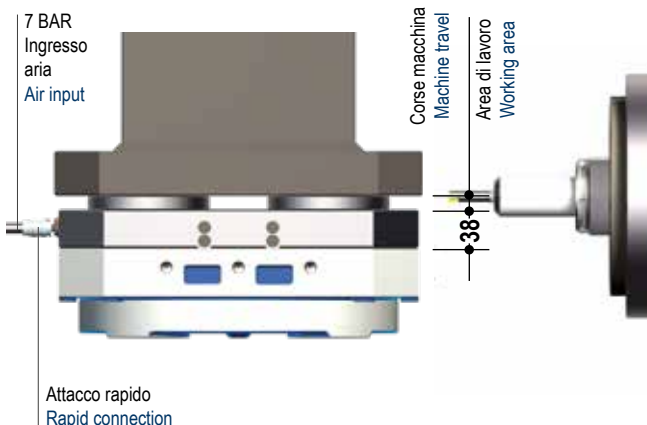

Gli "Zero Point Gerardi" sono utilizzabili anche per ottimizzare le corse del Vs. centro orizzontale sollevando il pezzo all'altezza desiderata senza l'ausilio di sovravole.

Our hydraulic or pneumatic "Zero Point Gerardi" are also used to optimize the vertical travel of your horizontal machining center without the need of extra over pallet plates.

Fig.4
Pic.4

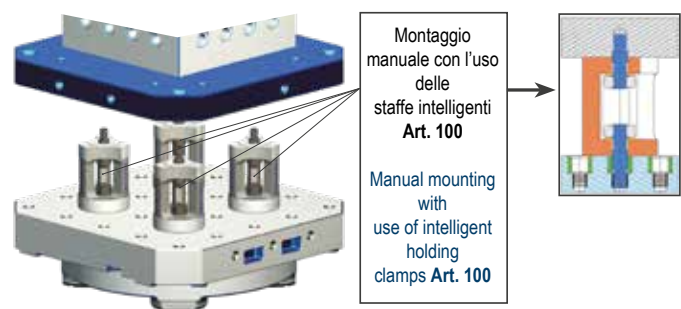

I fori di predisposizione (Fig.1- pag. 8.5) possono essere usati anche per l'utilizzo di "staffe intelligenti" Art.100 e relativi prigionieri.

The pre-work holes (Pic.1- pag. 8.5) are also coming handy for the use of our "intelligent clamps" Art. 100

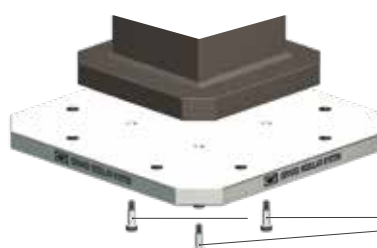

Inoltre con questo sistema di predisposizione potete fissare una piastra che vi permette l'interfacciamento sulla Vs. macchina o attrezzatura. (Fig.1)

Further more with this solution you can fix any plate you wish to adapt as you need (Pic.1)

Art. 100



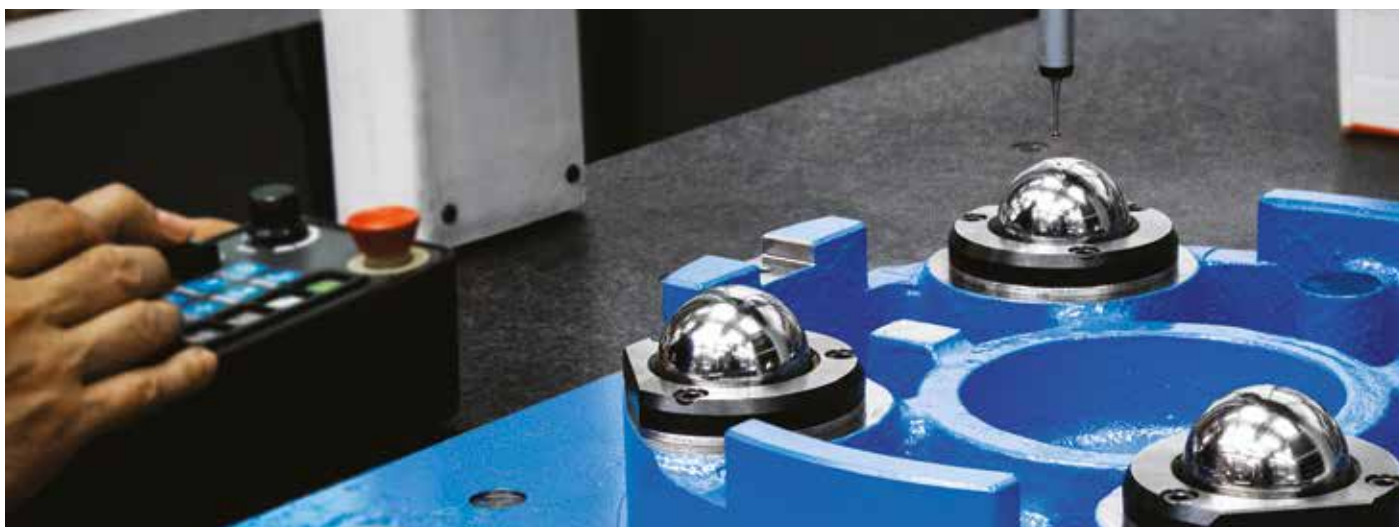

VERIFICHE DIMENSIONALI TRAMITE MACCHINE DI MISURA

DIMENSIONAL CHECK THROUGH MEASUREMENT MACHINES

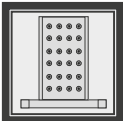
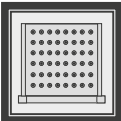

SIMBOLOGIA DATI TECNICI

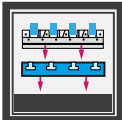
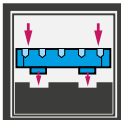
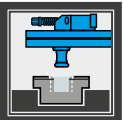
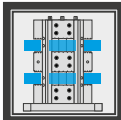
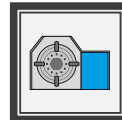
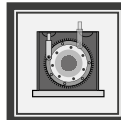
TECHNICAL DATA ICONS

MODELLI PORTAPEZZI TOMBSTONE MODELS			 Cubi Cubes	 Spalle 2 Sides tombstones	 Cubi a croce Cross cubes	 Squadre Angles
PIASTRE E PALLET PLATES AND PALLET					 Piastre e sovratavole Plates & Interfaced plates	 Pallet macchina Machine pallet
POSSIBILITÀ DI POSSIBILITY OF			 Posizionamento & cambio rapido Quick change & positioning	 Cubi-morsa Vise tower	 Divisore Automatico Automatic dividing head	 Divisore Meccanico Mechanical dividing head
PAGINE PAGES					 Accessori & Ricambi Accessories & Spare Parts	 Istruzioni corretto utilizzo Instruction for a proper use