

F90-20L

TYPE 2



2

Dati tecnici - Technical data

Ratio 1:1	Kg ISO/BT50 19 Kg
Rpm 3.500	Ø 20
N 1.460	M 14
Nm 85	ER32 Ø2/20

Senso di rotazione Contrario al mandrino - Direction of rotation Opposite to the machine spindle

Coni - Shanks	SK DIN 69871	CAT AcNSI B5.50	BT MAS 403	HSK DIN 69893	C.ISO 26623	KM	ISO DIN 2080		
Grandezza - Size	50	50	50	80	100	C8	80	100	50
Dual contact (Optional)									
H Standard Ø18	80	80	80	80	80	80	80	80	80
110 - Ø18									
110 - Ø28									
A	260	260	268	269	269	264	260	260	260
B	35	35	43	44	44	39	-	-	35

IMBALLO & PESO - PACK WEIGHT:

Cassa in Legno - Wooden Box 33Kg



DOTAZIONE STANDARD - STANDARD EQUIPMENT

Cassa in Legno / Stop block / Ghiera ER / Chiavi di servizio

Tubetto di grasso / Libro istruzioni

Wooden Box / Stop block / ER nut / Wrenches / Grease tube / Instruction book

OPZIONI - OPTIONS

OUTPUT - HSK 40

OUTPUT - Shell mill holder Ø22/27/32

OUTPUT - Weldon Max Ø25

OUTPUT - ER 40

OUTPUT - C4

OUTPUT - ISO-CAT-BT 30

PINZA - COLLET - ER32 Ø2/20

INTERASSE SPECIALE - SPECIAL PITCH - Cono > Perno - Shank > Pin

ATC SERIES AUTOMATIC TOOL CHANGE



INGRANAGGI - GEARS

Ingranaggi Gleason con evolvente rettificato massime performances e minori vibrazioni

Gleason ground spiral bevel gears maximum performances and minimum vibration



STOP BLOCK

con bussola cementata e guarnizione with case hardened bushing and gasket



CUSCINETTI - BEARINGS

Cuscinetti a sfera a contatto obliquo in classe di precisione ABEC 9

Angular contact preloaded ball bearings of precision class ABEC 9

DESIGN

Il Design compatto, insieme alle specifiche descritte, consente: alte performances, elevate velocità, lunga durata degli utensili.

The Compact design, along with mentioned specifications, allows: highest performances, high speeds, long tools life

Albero cementato, temprato, rettificato
Case hardened and ground shank and shaft

Perno di riferimento con sbloccaggio automatico del porta utensile

Positioning pin with automatic release

Gruppo antirotante modulare
Modular antirotation group

Passaggio refrigerante 10BAR attraverso il perno

Standard 10BAR coolant through the pin

Anello graduato
Graduated ring

Corpo testa orientabile a 360° con pressurizzazione interna.
In acciaio trattato, massima rigidità e resistenza alla corrosione. Minima dilatazione termica.

Treated steel head body with 360° position and internal air pressure, maximum rigidity and corrosion resistant. Minimum thermal expansion

USCITE - OUTPUTS:

- Portapinza ER (standard)
 - Weldon
- Portafresa
 - Speciale
- ER collet (standard)
 - Weldon
- Shell mill holder
 - Special



Ciascun albero di trasmissione supportato da cuscinetti a contatto obliquo, che garantiscono rotazioni dell'albero-cono e dell'uscita portautensile entro 0,01 mm
Each transmission shaft is supported by slanting bearings that ensure the shaft with shank and the toolholder output rotations within 0,01mm.

Teste Angolari / Angle Heads

EVOLUTION LINE



Velocità / High-speed
10.000 Rpm



Internal coolant
fino a / Up to
70Bar

Teste Angolari Modulari ! - Modular Angle heads !

2

from 2.11 to 2.61

SERIE ATC / ATC SERIES

Le teste ATC (Automatic Tool Change) sono ideali per le macchine di produzione a controllo numerico con cambio utensili automatico. Sono trasportabili automaticamente dal magazzino utensili al mandrino macchina e viceversa. Corpo testa orientabile di 360° su ASSE MANDRINO.

Sulle teste modello FMU, il supporto del mandrino portautensile ha possibilità di inclinarsi di $\pm 90^\circ$. Se la testa non è in posizione di lavoro, un sistema di aggancio impedisce la rotazione del cono rispetto al corpo testa.

ATC angle heads are ideal for CNC machines with automatic tool change and can be automatically transferred from the tool store to the machine spindle and vice-versa. Angle head body adjustable at 360° on SPINDLE AXIS. On FMU heads, the cutter spindle housing can be adjusted at $\pm 90^\circ$. If an ATC angle head is not placed into the machine spindle, a locking system prevents shank rotation relative to the head body.



from 2.63 to 2.68

SERIE MTC / MTC SERIES

Linea di teste per le macchine non dotate di cambio utensili automatico. Le teste MTC (Manual Tool Change) vanno montate manualmente e fissate al mandrino tramite flangiatura. Sulle teste modello FMU, il supporto del mandrino portautensile ha la possibilità di inclinarsi e di posizionarsi di $\pm 90^\circ$.

This is a range of heads is for conventional machines without automatic tool change. MTC angle heads (Manual Tool Change) are manually mounted on the machine headstock through a flange. On FMU heads, the cutter spindle housing can be adjusted at $\pm 90^\circ$.



Flangia universale
Universal Flange

* Prolunga - Extension
(Opzionale - Optional)



Coni Intercambiabili Interchangeable Shanks

Coni intercambiabili per un utilizzo su più centri di lavoro. Una sola testa per più centri di lavoro

Interchangeable driven tapers to fit any machine spindle. One head for many machines



Cuscinetti ABEC 9 ABEC 9 Ball Bearings

Ciascun albero di trasmissione è supportato da una coppia di cuscinetti a contatto obliquo, precaricati in classe di precisione ABEC 9 e lubrificati con grasso a vita.

Shafts supported by sets of super precision pre-loaded angular contact bearings with Long Life grease lubrication and ABEC 9 accuracy rating



Corpo testa in acciaio Steel head body

Corpo testa orientabile a 360° con pressurizzazione interna. In acciaio trattato, massima rigidità e resistenza alla corrosione. Minima dilatazione termica

Treated steel head body with 360° position and internal air pressure, maximum rigidity and corrosion resistant. Minimum thermal expansion



Ingranaggi Gleason Gleason Spiral bevel gears

Ingranaggi conici spirodali in materiale ad alta resistenza, rettificati per garantire minore riscaldamento e rumorosità ed elevato numero di giri. Calcolo computerizzato della coppia conica degli ingranaggi (gleason): più denti in presa, più coppia in uscita, maggior numero di ore di lavorazione, rumorosità quasi assente.

Ground spiral bevel gears in the highest performance materials able to guaranteed less warming and noise and the highest Rpm. Computerized computation of the data of the set gears more than one tooth working during mesh, more power transmitted, longer gear life, almost no noise

Le teste angolari Gerardi della nuovissima Linea Evolution nascono da solide basi tecniche e dall'esperienza maturata in 40 anni trascorsi al fianco dei nostri clienti durante i quali abbiamo risolto i problemi più variegati cercando la soluzione migliore e garantendo sempre l'elevata qualità ed affidabilità dei nostri prodotti. 104 modelli di teste angolari standard, ideati, realizzati e distribuiti in oltre 50 paesi nel mondo dalla Gerardi S.p.A., corredati da una gamma di opzioni che ne completano le potenzialità applicative e prestazionali.

The new Evolution line of Gerardi angle heads has been designed from a technical base derived from 40 years experience of solving thousands of production problems, finding optimum solutions and always guaranteeing the highest product quality 104 standard angle head types are now offered, designed, built and distributed in more than 50 countries the world over by Gerardi S.p.A., and available with a range of options to complete their application and performance potentials.

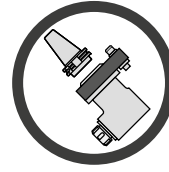

SCAN IT TO SEE



THE WEB PAGE



Linea di teste angolari modulari Modular angle heads series!

2



Uscite regolabili FMU FMU Adjustable output

Operazioni orizzontali, verticali e angolari con una sola testa. Uscita completamente regolabile con angolazione $\pm 90^\circ$

Vertical, horizontal and angular machining operations with one angle head only. Fully adjustable output $\pm 90^\circ$



Refrigerante 10BAR
attraverso il perno
Standard 10BAR
coolant through the pin

Teste Slim, ideali
per MICROLAVORAZIONI
Slim Angle heads ideal for
MICROMACHINING

PASSAGGIO REFRIGERANTE - COOLANT TYPES:



10bar

- » Perno
- » Utensile
- » Positioning pin
- » Tool



10bar

- » Perno
- » Distributore
- » Utensile
- » Positioning Pin
- » Rotating Distributor
- » Tool



**up to
70bar**

- » Cono
- » Distributore
- » Utensile
- » Shank
- » Rotating Distributor
- » Tool



**up to
150bar**

- » Perno
- » Ghiera ReCool
- » Utensile
- » Positioning Pin
- » ReCool Nut
- » Tool

MODULARITÀ SENZA MODULARITY WITHOUT

UNA SOLA TESTA PER PIÙ CENTRI DI LAVORO
ONE HEAD FOR MANY MACHINES

Coni intercambiabili per un utilizzo su più centri di lavoro!!
Interchangeable drive tapers to suit any machine spindle!!



F90-10 / ATC
ISO-40 / 65



HSK-63



STOP-BLOCK

**UN INVESTIMENTO CHE
SI RIPAGA VELOCEMENTE !!
QUICKEST RETURN ON YOUR
INVESTMENT !!**

COMPROMESSI COMPROMISES

UN SOLO CENTRO DI LAVORO CON PIÙ TESTE
THE SAME MACHINE WITH MANY HEADS

Lavorare nelle migliori condizioni risparmiando sui costi di acquisto !!
A system to save costs !!



2

UNA SOLUZIONE
APERTA PER IL LAVORO DI OGGI ,
PENSANDO A QUELLO DI DOMANI
BE REAY FOR TOMORROW
WITH THE HEAD YOU BUY TODAY !!

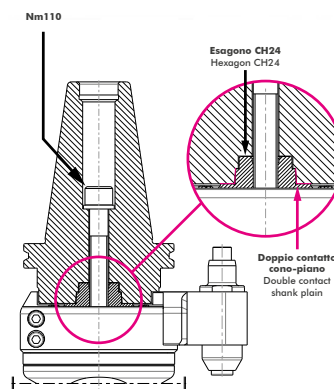

PERNO DI POSIZIONAMENTO MO-
DULARE INTERCAMBIABILE
A SCELTA
A CHOICE OF MODULAR INTER-
CHANGEABLE ARRESTER PINS

IL DOPPIO CONTATTO CONO E
PIANO ASSICURANO RIGIDITÀ
E PRECISIONE !!
THE UNIQUE GERARDI TAPER AND
FACE LOCATION ENSURE RIGIDITY
AND ACCURACY !!

Novità / News

Evolution Line

Nuovi Modelli di Teste Angolari Integrali

New Types of Integral Angle Heads

2



STD 90° LONG SERIES

Teste angolari light con corpo in alluminio FL90-13L e FL90-16L
New light angle heads with aluminum body FL90-13L and FL90-16L



FMU SERIES

Testa angolare light in alluminio FLU con angolazione regolabile da 0° a 180°
New angle head light FLU with aluminum bodies with adjustable angle from 0° to 180°



STD 90° SERIES

Testa angolare F90-20L con cono integrale
Angle head model F90-20L with integral shank



OFFSET SERIES

Gamma di teste disassate con refrigerante interno fino a 70bar.
New offset heads range with internal coolant up to 70 bar.

Esempi applicativi / Applications examples

Linea Evolution

Teste angolari integrali serie ATC (Cambio utensile automatico)

Integral angle heads ATC series (Automatic tool change)

2



SLIM SERIES

Ideali per Microlavorazioni in spazi ristretti
Ideal for Micromachining in narrow spaces



STD 90° SERIES

La serie ideale per fresature, forature e maschiature a $\pm 90^\circ$
The ideal series for milling, drilling and tapping at $\pm 90^\circ$



COOLANT SERIES

La serie di teste angolari con passaggio refrigerante dal perno, uscita utensile 10bar
With coolant input from the main positioning pin and output through the tool at 10bar



FMU SERIES

La serie di teste angolari con angolazione regolabile da $0 \pm 90^\circ$.
Angle heads series with adjustable angle from $0 \pm 90^\circ$.



DOUBLE SERIES

La serie di teste angolari ideali per fresature, forature e maschiature attraverso 2 mandrini contrapposti di 180°
Angle Heads series for milling drilling and tapping through 2 opposite outputs











OFFSET SERIES









Testa angolari disassate per lavorazioni in spazi ristretti con opzione passaggio refrigerante dal cono, uscita utensile 70 BAR
Offset series for machining in narrow spaces with coolant input directly from machine spindle and output through the tool at 70 BAR

SIMBOLOGIA DATI TECNICI TECHNICAL DATA LOGOS

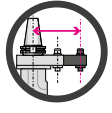
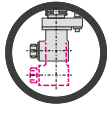
2

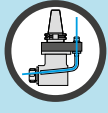
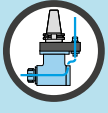
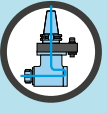
							
Rapporto trasmissione Ratio	Numero di giri Revolutions per minute Rpm	Carico assiale Axial load N	Coppia Torque Nm	Peso Weight Kg	Uscita Output Ø	Maschio Tapping M	Pinza Collet Ø

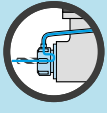
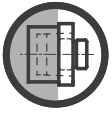
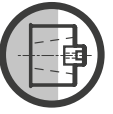
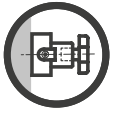
INDICE OPZIONI OPTIONS INDEX

OPZIONI OPTIONS					
	Alta velocità High speed	Spina per posizionamento rapido Quick positioning pin	Interasse speciale Special pitch	Lunghezze speciali Special length	Flangia Multipoint Multipoint flange
PASSAGGIO REFRIGERANTE COOLANT					
	Attaverso il perno Through the Pin 10bar (standard) ROTAZ. a SECCO DRY RUNNING ✓	Perno » Distrib » Utensile Pin » Distributor » Tool 10bar ROTAZ. a SECCO DRY RUNNING ✓	Cono » Distrib » Utensile Shank » Distributor » Tool 70bar ROTAZ. a SECCO DRY RUNNING NO	Distributore » Utensile Distributor » Tool 10bar ROTAZ. a SECCO DRY RUNNING NO	Perno » Ghiera » Utensile Pin » Distrib » Tool ReCool NUT
USCITA OUTPUT					
	Uscita HSK HSK output	Uscita ISO ISO output	Uscita portafresa Shell mill holder output	Uscita WELDON WELDON output	Uscita C. C. output