

### F90-20 10BAR

TYPE 2



#### Dati tecnici - Technical data



Ratio  
1:1



ISO/BT50  
13,4 Kg



Rpm  
3.500



Ø 20



N 1.460



M 14



Nm 85



ER32 WP  
Ø2/20

Senso di rotazione Contrario al mandrino - Direction of rotation Opposite to the machine spindle

Coni - Shanks	SK DIN 69871	CAT Ac/NSI B5.50	BT MAS 403	HSK DIN 69893	C.ISO 26623	KM	ISO DIN 2080		
Grandezza - Size	50	50	50	80	100	C8	80	100	50
Dual contact (Optional)									
<b>H</b>									
Standard Ø18	80	80	80	80	80	80	80	80	80
110 - Ø18									
110 - Ø28									
<b>A</b>	185	185	193	194	194	189	185	185	185
<b>B</b>	35	35	43	44	44	39	-	-	35

#### IMBALLO & PESO - PACK WEIGHT:

Valigetta - Bag 17Kg



#### DOTAZIONE STANDARD - STANDARD EQUIPMENT

Valigetta / Stop block / Ghiera ER / Chiavi di servizio  
Tubetto di grasso / Libro istruzioni

Special bag / Stop block / ER nut / Wrenches / Grease tube / Instruction book

#### OPZIONI - OPTIONS

OUTPUT - Shell mill holder

OUTPUT - Weldon Max Ø25

OUTPUT - HSK 40

OUTPUT - ER40

PINZA - COLLET - ER32 Ø2/20

PINZA - COLLET - ER32 WP - Ø3/20

OUTPUT - C4

## ATC SERIES AUTOMATIC TOOL CHANGE



### INGRANAGGI - GEARS

Ingranaggi Gleason con evolvente rettificato massime performances e minori vibrazioni

Gleason ground spiral bevel gears maximum performances and minimum vibration



### STOP BLOCK

con bussola cementata e guarnizione with case hardened bushing and gasket



### CUSCINETTI - BEARINGS

Cuscinetti a sfera a contatto obliquo in classe di precisione ABEC 9

Angular contact preloaded ball bearings of precision class ABEC 9

### DESIGN

Il Design compatto, insieme alle specifiche descritte, consente: alte performances, elevate velocità, lunga durata degli utensili.

The Compact design, along with mentioned specifications, allows: highest performances, high speeds, long tools life

**Albero cementato, temprato, rettificato**  
Case hardened and ground shank and shaft

**Perno di riferimento con sbloccaggio automatico del porta utensile**  
Positioning pin with automatic release

**Gruppo antirotante modulare**  
Modular antirotation group

**Passaggio refrigerante 10BAR attraverso il perno**  
Standard 10BAR coolant through the pin

**Anello graduato**  
Graduated ring

**Corpo testa orientabile a 360° con pressurizzazione interna.**  
In acciaio trattato, massima rigidità e resistenza alla corrosione. Minima dilatazione termica.

Treated steel head body with 360° position and internal air pressure, maximum rigidity and corrosion resistant. Minimum thermal expansion

### USCITE - OUTPUTS:

- Portapinza ER (standard)
  - Weldon
- Portafresa
  - Speciale
- ER collet (standard)
  - Weldon
- Shell mill holder
  - Special



Ciascun albero di trasmissione supportato da cuscinetti a contatto obliquo, che garantiscono rotazioni dell'albero-cono e dell'uscita portautensile entro 0,01 mm  
Each transmission shaft is supported by slanting bearings that ensure the shaft with shank and the toolholder output rotations within 0,01mm.

## Teste Angolari / Angle Heads

# EVOLUTION LINE



Velocità / High-speed  
10.000 Rpm



Internal coolant  
fino a / Up to  
70Bar

### Teste Angolari Modulari ! - Modular Angle heads !

2

from 2.11 to 2.61

#### SERIE ATC / ATC SERIES

Le teste ATC (Automatic Tool Change) sono ideali per le macchine di produzione a controllo numerico con cambio utensili automatico. Sono trasportabili automaticamente dal magazzino utensili al mandrino macchina e viceversa. Corpo testa orientabile di 360° su ASSE MANDRINO.

Sulle teste modello FMU, il supporto del mandrino portautensile ha possibilità di inclinarsi di  $\pm 90^\circ$ . Se la testa non è in posizione di lavoro, un sistema di aggancio impedisce la rotazione del cono rispetto al corpo testa.

ATC angle heads are ideal for CNC machines with automatic tool change and can be automatically transferred from the tool store to the machine spindle and vice-versa. Angle head body adjustable at 360° on SPINDLE AXIS. On FMU heads, the cutter spindle housing can be adjusted at  $\pm 90^\circ$ . If an ATC angle head is not placed into the machine spindle, a locking system prevents shank rotation relative to the head body.



from 2.63 to 2.68

#### SERIE MTC / MTC SERIES

Linea di teste per le macchine non dotate di cambio utensili automatico. Le teste MTC (Manual Tool Change) vanno montate manualmente e fissate al mandrino tramite flangiatura. Sulle teste modello FMU, il supporto del mandrino portautensile ha la possibilità di inclinarsi e di posizionarsi di  $\pm 90^\circ$ .

This is a range of heads is for conventional machines without automatic tool change. MTC angle heads (Manual Tool Change) are manually mounted on the machine headstock through a flange. On FMU heads, the cutter spindle housing can be adjusted at  $\pm 90^\circ$ .



Flangia universale  
Universal Flange

\* Prolunga - Extension  
(Opzionale - Optional)



#### Coni Intercambiabili Interchangeable Shanks

Coni intercambiabili per un utilizzo su più centri di lavoro. Una sola testa per più centri di lavoro

Interchangeable driven tapers to fit any machine spindle. One head for many machines



#### Cuscinetti ABEC 9 ABEC 9 Ball Bearings

Ciascun albero di trasmissione è supportato da una coppia di cuscinetti a contatto obliquo, precaricati in classe di precisione ABEC 9 e lubrificati con grasso a vita.

Shafts supported by sets of super precision pre-loaded angular contact bearings with Long Life grease lubrication and ABEC 9 accuracy rating



#### Corpo testa in acciaio Steel head body

Corpo testa orientabile a 360° con pressurizzazione interna. In acciaio trattato, massima rigidità e resistenza alla corrosione. Minima dilatazione termica

Treated steel head body with 360° position and internal air pressure, maximum rigidity and corrosion resistant. Minimum thermal expansion



#### Ingranaggi Gleason Gleason Spiral bevel gears

Ingranaggi conici spirodali in materiale ad alta resistenza, rettificati per garantire minore riscaldamento e rumorosità ed elevato numero di giri. Calcolo computerizzato della coppia conica degli ingranaggi (gleason): più denti in presa, più coppia in uscita, maggior numero di ore di lavorazione, rumorosità quasi assente.

Ground spiral bevel gears in the highest performance materials able to guaranteed less warming and noise and the highest Rpm. Computerized computation of the data of the set gears more than one tooth working during mesh, more power transmitted, longer gear life, almost no noise

Le teste angolari Gerardi della nuovissima Linea Evolution nascono da solide basi tecniche e dall'esperienza maturata in 40 anni trascorsi al fianco dei nostri clienti durante i quali abbiamo risolto i problemi più variegati cercando la soluzione migliore e garantendo sempre l'elevata qualità ed affidabilità dei nostri prodotti. 104 modelli di teste angolari standard, ideati, realizzati e distribuiti in oltre 50 paesi nel mondo dalla Gerardi S.p.A., corredati da una gamma di opzioni che ne completano le potenzialità applicative e prestazionali.

The new Evolution line of Gerardi angle heads has been designed from a technical base derived from 40 years experience of solving thousands of production problems, finding optimum solutions and always guaranteeing the highest product quality 104 standard angle head types are now offered, designed, built and distributed in more than 50 countries the world over by Gerardi S.p.A., and available with a range of options to complete their application and performance potentials.

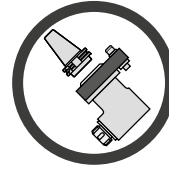

SCAN IT TO SEE



THE WEB PAGE



## Linea di teste angolari modulari Modular angle heads series!

2



### Uscite regolabili FMU FMU Adjustable output

Operazioni orizzontali, verticali e angolari con una sola testa. Uscita completamente regolabile con angolazione  $\pm 90^\circ$

Vertical, horizontal and angular machining operations with one angle head only. Fully adjustable output  $\pm 90^\circ$



Refrigerante 10BAR  
attraverso il perno  
Standard 10BAR  
coolant through the pin

Teste Slim, ideali  
per MICROLAVORAZIONI  
Slim Angle heads ideal for  
MICROMACHINING

### PASSAGGIO REFRIGERANTE - COOLANT TYPES:



10bar

- » Perno
- » Utensile
- » Positioning pin
- » Tool



10bar

- » Perno
- » Distributore
- » Utensile
- » Positioning Pin
- » Rotating Distributor
- » Tool



up to  
70bar

- » Cono
- » Distributore
- » Utensile
- » Shank
- » Rotating Distributor
- » Tool



up to  
150bar

- » Perno
- » Ghiera ReCool
- » Utensile
- » Positioning Pin
- » ReCool Nut
- » Tool

# MODULARITÀ SENZA MODULARITY WITHOUT

**UNA SOLA TESTA PER PIÙ CENTRI DI LAVORO**  
**ONE HEAD FOR MANY MACHINES**

Coni intercambiabili per un utilizzo su più centri di lavoro!!  
Interchangeable drive tapers to suit any machine spindle!!



F90-10 / ATC  
ISO-40 / 65



HSK-63



STOP-BLOCK

**UN INVESTIMENTO CHE  
SI RIPAGA VELOCEMENTE !!  
QUICKEST RETURN ON YOUR  
INVESTMENT !!**



# COMPROMESSI COMPROMISES

UN SOLO CENTRO DI LAVORO CON PIÙ TESTE  
THE SAME MACHINE WITH MANY HEADS

Lavorare nelle migliori condizioni risparmiando sui costi di acquisto !!  
A system to save costs !!



2

**UNA SOLUZIONE  
APERTA PER IL LAVORO DI OGGI ,  
PENSANDO A QUELLO DI DOMANI  
BE REAY FOR TOMORROW  
WITH THE HEAD YOU BUY TODAY !!**

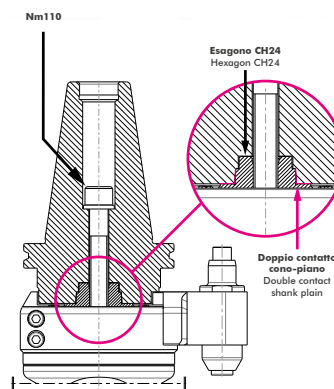

**PERNO DI POSIZIONAMENTO MO-  
DULARE INTERCAMBIABILE  
A SCELTA**  
A CHOICE OF MODULAR INTER-  
CHANGEABLE ARRESTER PINS

**IL DOPPIO CONTATTO CONO E  
PIANO ASSICURANO RIGIDITÀ  
E PRECISIONE !!**  
THE UNIQUE GERARDI TAPER AND  
FACE LOCATION ENSURE RIGIDITY  
AND ACCURACY !!

Novità / News

# Evolution Line

## Nuovi Modelli di Teste Angolari Integrali

New Types of Integral Angle Heads

2



**STD 90°** LONG SERIES

Teste angolari light con corpo in alluminio FL90-13L e FL90-16L  
New light angle heads with aluminum body FL90-13L and FL90-16L



**FMU** SERIES

Testa angolare light in alluminio FLU con angolazione regolabile da 0° a 180°  
New angle head light FLU with aluminum bodies with adjustable angle from 0° to 180°



**STD 90°** SERIES

Testa angolare F90-20L con cono integrale  
Angle head model F90-20L with integral shank



**OFFSET** SERIES

Gamma di teste disassate con refrigerante interno fino a 70bar.  
New offset heads range with internal coolant up to 70 bar.

Esempi applicativi / Applications examples

# Linea Evolution

**Teste angolari integrali serie ATC (Cambio utensile automatico)**

*Integral angle heads ATC series (Automatic tool change)*

2



**SLIM** SERIES

Ideali per Microlavorazioni in spazi ristretti  
Ideal for Micromachining in narrow spaces



**STD 90°** SERIES

La serie ideale per fresature, forature e maschiature a  $\pm 90^\circ$   
The ideal series for milling, drilling and tapping at  $\pm 90^\circ$



**COOLANT** SERIES

La serie di teste angolari con passaggio refrigerante dal perno, uscita utensile 10bar  
With coolant input from the main positioning pin and output through the tool at 10bar



**FMU** SERIES

La serie di teste angolari con angolazione regolabile da  $0 \pm 90^\circ$ .  
Angle heads series with adjustable angle from  $0 \pm 90^\circ$ .



**DOUBLE** SERIES

La serie di teste angolari ideali per fresature, forature e maschiature attraverso 2 mandrini contrapposti di  $180^\circ$   
Angle Heads series for milling drilling and tapping through 2 opposite outputs











**OFFSET** SERIES

Testa angolari disassate per lavorazioni in spazi ristretti con opzione passaggio refrigerante dal cono, uscita utensile 70 BAR  
Offset series for machining in narrow spaces with coolant input directly from machine spindle and output through the tool at 70 BAR









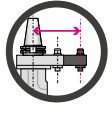
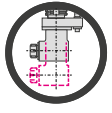

## SIMBOLOGIA DATI TECNICI TECHNICAL DATA LOGOS

2

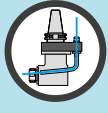
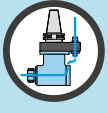
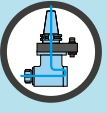
							
<b>Rapporto trasmissione</b> Ratio	<b>Numero di giri</b> Revolutions per minute Rpm	<b>Carico assiale</b> Axial load N	<b>Coppia</b> Torque Nm	<b>Peso</b> Weight Kg	<b>Uscita</b> Output Ø	<b>Maschio</b> Tapping M	<b>Pinza</b> Collet Ø

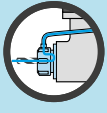
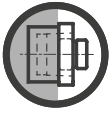
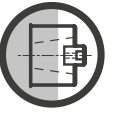
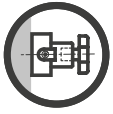
## INDICE OPZIONI OPTIONS INDEX

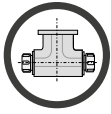
<b>OPZIONI</b> OPTIONS						
	<b>Alta velocità</b> High speed	<b>Spina per posizionamento rapido</b> Quick positioning pin	<b>Interasse speciale</b> Special pitch	<b>Lunghezze speciali</b> Special lenght	<b>Flangia Multipoint</b> Multipoint flange	
<b>PASSAGGIO REFRIGERANTE</b> COOLANT						
	<b>Attraverso il perno</b> Through the Pin  10bar (standard) <b>ROTAZ. a SECCO</b> DRY RUNNING ✓	<b>Perno » Distrib » Utensile</b> Pin » Distributor » Tool 10bar <b>ROTAZ. a SECCO</b> DRY RUNNING ✓	<b>Cono » Distrib » Utensile</b> Shank » Distributor » Tool 70bar <b>ROTAZ. a SECCO</b> DRY RUNNING NO	<b>Distributore » Utensile</b> Distributor » Tool 10bar <b>ROTAZ. a SECCO</b> DRY RUNNING NO	<b>Perno » Ghiera » Utensile</b> Pin » Distrib » Tool  <b>ReCool NUT</b>	
<b>USCITA</b> OUTPUT						
	<b>Uscita HSK</b> HSK output	<b>Uscita ISO</b> ISO output	<b>Uscita portafresa</b> Shell mill holder output	<b>Uscita WELDON</b> WELDON output	<b>Uscita C.</b> C. output	<b>Doppia uscita</b> Double ouput