

Teste Angolari / Angle Heads CLASSIC LINE



Velocità / High-speed
10.000 Rpm



Internal coolant
fino a / Up to
70Bar

Cono e Albero Integrali - Integral Shank & Shaft !

from 1.10 to 1.54

SERIE ATC / ATC SERIES

E' la linea di teste adatte ai centri di lavoro, trasportabile automaticamente dal magazzino utensili al mandrino e viceversa. Corpo testa orientabile di 360° su ASSE MANDRINO. Quando la testa non è in posizione di lavoro, un sistema di aggancio impedisce la rotazione del cono rispetto al corpo testa. Una caratteristica primaria delle teste Classic - ATC è l'albero centrale realizzato in un solo pezzo con il cono di attacco, per offrire la massima rigidità. Recentissima novità è il perno di fermo intercambiabile.

This range of heads is designed to be used on machining centres and can be automatically transferred from the tool magazine to the machine spindle and back. Angle head body adjustable at 360° on SPINDLE AXIS. This allows easy adjustment of the drive taper and head relative to arresster block mounted on the front of the machining centres' spindle housing. When the head is unloaded from the machine spindle, a safety latch prevents the drive taper from rotating. A major feature of the Classic ATC heads is the main input shaft which is integral with the drive taper to ensure maximum rigidity. The last news is the interchangeable positioning pin.

from 1.57 to 1.88

SERIE MTC / MTC SERIES

E' la linea di teste adatte a macchine utensili tradizionali e da fissare al mandrino tramite flangiatura. La cava a "T" ricavata sulla flangia universale permette un facile posizionamento del corpo testa sui 360° intorno al suo asse verticale. Un sistema modulare componibile, rende possibile variare la lunghezza del corpo testa aggiungendo l'elemento di prolunga. Modulo di prolunga, coni e flangia universale sono modulari e quindi intercambiabili su tutti i corpi testa appartenenti allo stesso ordine di grandezza.

This is a range of heads for traditional machine tools with flange attachment. The T-slot on the universal flange facilitates positioning the head 360° around its vertical axis. The modular system makes it possible to extend the length of the body by adding a spacer. The extension spacer, drive tapers and universal flange are modular and therefore interchangeable among all the heads of similar size.



Albero & Cono Integrale Integral Shank & Shaft

Albero con cono di attacco integrale (cementato, temprato e rettificato) per garantire la massima rigidità. Intercambiabili per un utilizzo su più centri di lavoro.

Main shaft is one solid piece with the drive input taper, case hardened and ground, to ensure maximum rigidity. They are interchangeable to fit any machine spindle



Cuscinetti ABEC 9 ABEC 9 Ball Bearings

Ciascun albero di trasmissione è supportato da una coppia di cuscinetti a contatto obliquo, precaricati in classe di precisione ABEC 9 e lubrificati con grasso a vita

Shafts supported by sets of super precision pre-loaded angular contact bearings with Long Life grease lubrication and ABEC 9 accuracy rating



Corpo Principale Main Body

Corpo testa orientabile a 360° con pressurizzazione interna. In acciaio trattato, massima rigidità e resistenza alla corrosione. Minima dilatazione termica

Treated steel head body with 360° position and internal air pressure, maximum rigidity and corrosion resistant. Minimum thermal expansion



Ingranaggi Gleason Gleason Gears

Ingranaggi conici spiroidali in materiale ad alta resistenza, rettificati per garantire minore riscaldamento e rumorosità ed elevato numero di giri. Calcolo computerizzato della coppia conica degli ingranaggi (gleason): più denti in presa, più coppia in uscita, maggior numero di ore di lavorazione, rumorosità quasi assente.

Ground spiral bevel gears in the highest performance materials able to guaranteed less warming and noise and the highest Rpm. Computerized computation of the data of the set gears more than one tooth working during mesh, more power transmitted, longer gear life, almost no noise

In continuo sviluppo, la gamma di teste Classic Line, è oggi composta da 252 modelli completamente compatibili con la Linea Evolution e con qualunque macchina sul mercato grazie all'ampia gamma di coni disponibili. L'obiettivo è sempre lo stesso: Ottimizzare i cicli, semplificare e migliorare sempre di più la qualità di qualsiasi tipo di lavorazione su centri orizzontali & verticali. Le Teste Angolari Gerardi della linea Classic nascono da solide basi tecniche e dall'esperienza maturata da oltre 50 anni trascorsi al fianco dei nostri clienti durante i quali abbiamo risolto i problemi più variegati cercando la soluzione migliore e garantendo sempre l'elevata qualità ed affidabilità dei nostri prodotti.

The Classic Line Angle Heads range is constantly evolving and it currently consists of 252 items, all compatible with both Evolution Line Angle Heads and all machining centres on the market thanks to the wide range of shanks available. Our goal is always the same: optimizing the production chain by simplifying and improving more and more every type of operation on horizontal and vertical machining centres. The new Classic line of Gerardi angle heads has been designed from a technical base derived from more than 50-years-experience in solving thousands of production problems, finding optimum solutions and always guaranteeing the highest product quality.

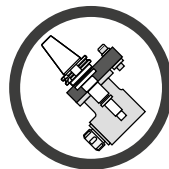

SCAN IT TO SEE



THE WEB PAGE



Linea di teste angolari integrali! Integral angle heads series!

Uscite regolabili GMU GMU Adjustable output

Operazioni orizzontali, verticali e angolari con una sola testa. Uscita completamente regolabile con angolazione $\pm 90^\circ$

Vertical, horizontal and angular machining operations with one angle head only. Fully adjustable output $\pm 90^\circ$



Refrigerante 10BAR
attraverso il perno
Standard 10BAR
coolant through the pin



Manipoli ad Angolo
90° Angle Spindle



PASSAGGIO REFRIGERANTE - COOLANT TYPES:



10bar

- » Perno
- » Utensile
- » Positioning pin
- » Tool



10bar

- » Perno
- » Distributore
- » Utensile
- » Positioning Pin
- » Rotating Distributor
- » Tool



up to
70bar

- » Cono
- » Distributore
- » Utensile
- » Shank
- » Rotating Distributor
- » Tool



up to
150bar

- » Perno
- » Ghiera ReCool
- » Utensile
- » Positioning Pin
- » ReCool Nut
- » Tool

1

Novità / News

Classic Line

Nuovi Modelli di Teste Angolari Integrali

New Types of Integral Angle Heads



MINI90° SERIES

La nuova serie di teste angolari con manipolo ad angolo intercambiabile per lavorazioni con utensile da Ø1,6 a Ø3
New series of angle heads with interchangeable angle spindle for machinings with Ø1,6 to Ø 3



EXTENDED SERIES

La serie di teste angolari EXTRA LUNGHE con torretta riportata.
New EXTENDED series angle heads with reported turret.



SLIM SERIES

Nuovo modello di testa standard a 90° per MICRO lavorazioni in ingombri minimi
New standard 90° head type for MICRO machining in minimum overall spaces



OFFSET SERIES

Nuova gamma di teste disassate con refrigerante interno fino a 70bar.
New offset heads range with internal coolant up to 70 bar.

Esempi applicativi / Applications examples

Classic Line

Teste angolari integrali MTC (Cambio utensile manuale)

Integral angle heads MTC series (Manual tool change)



STD 90° SERIES

La serie ideale per fresature, forature e maschiature a $\pm 90^\circ$
The ideal series for milling, drilling and tapping at $\pm 90^\circ$.



STD 90° SERIES

La serie ideale per fresature, forature e maschiature a $\pm 90^\circ$
The ideal series for milling, drilling and tapping at $\pm 90^\circ$.



GMU SERIES

La serie di teste angolari con angolazione regolabile da 0 a 90° .
Angle heads series with adjustable angle from 0 to 90° .

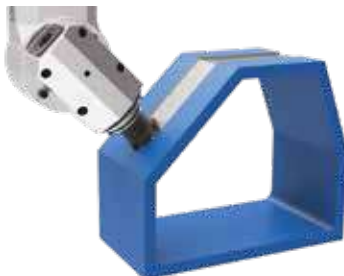

GMU SERIES

La serie di teste angolari con angolazione regolabile da 0 a 360° .
Angle heads series with adjustable angle from 0 to 360° .











DOUBLE SERIES









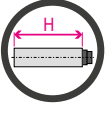
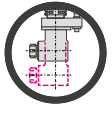

La serie di teste angolari ideali per fresature, forature e maschiature attraverso 2 mandrini contrapposti di 180°
Angle Heads series for milling drilling and tapping through 2 opposite outputs

1

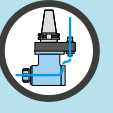
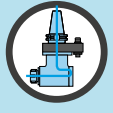
SIMBOLOGIA DATI TECNICI TECHNICAL DATA LOGOS

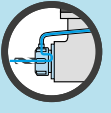
| | | | | | | | |
|---|---|---|---|---|---|---|---|
|  |  |  |  |  |  |  |  |
| Rapporto trasmissione Ratio | Numero di giri Revolutions per minute Rpm | Carico assiale Axial load N | Coppia Torque Nm | Peso Weight Kg | Uscita Output Ø | Maschio Tapping M | Pinza Collet Ø |

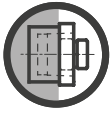
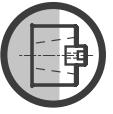
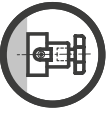
INDICE OPZIONI OPTIONS INDEX

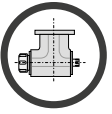
| | | | | | | | |
|--|--|--|--|---|---|---|---|
| OPZIONI OPTIONS |  |  |  |  |  |  | |
| | Manipolo ad angolo Angular chuck | Alta velocità High speed | Spina per posizionamento rapido Quick positioning pin | Prolunga per manipolo ad angolo Extension for angular chuck | Lunghezze speciali Special lenght | Flangia Multipoint Multipoint flange | |
| PASSAGGIO REFRIGERANTE COOLANT |  |  |  |  |  | | |
| | Attaverso il perno Through the Pin 10bar (standard) ROTAZ. a SECCO DRY RUNNING ✓ | Perno » Distrib » Utensile Pin » Distributor » Tool 10bar ROTAZ. a SECCO DRY RUNNING ✓ | Cono » Distrib » Utensile Shank » Distributor » Tool 30 / 40 / 70bar ROTAZ. a SECCO DRY RUNNING NO | Distributore » Utensile Distributor » Tool 10bar ROTAZ. a SECCO DRY RUNNING ✓ | Perno » Ghiera » Utensile Pin » Distrib » Tool ReCool NUT | | |
| USCITA OUTPUT |  |  |  |  |  |  |  |
| | Uscita ER ER output | Uscita HSK HSK output | Uscita ISO ISO output | Uscita portafresa Shell mill holder output | Uscita WELDON WELDON output | Uscita C. C. output | Doppia uscita Double output |

MTC SERIES MANUAL TOOL CHANGE



INGRANAGGI - GEARS

Ingranaggi Gleason con evolvente rettificato massime performances e minori vibrazioni

Gleason ground spiral bevel gears maximum performances and minimum vibration



CUSCINETTI - BEARINGS

Cuscinetti a sfera a contatto obliquo in classe di precisione ABEC 9

Angular contact preloaded ball bearings of precision class ABEC 9

DESIGN

Il Design compatto, insieme alle specifiche descritte, consente: alte performances, elevate velocità, lunga durata degli utensili.

The Compact design, along with mentioned specifications, allows: highest performances, high speeds, long tools life

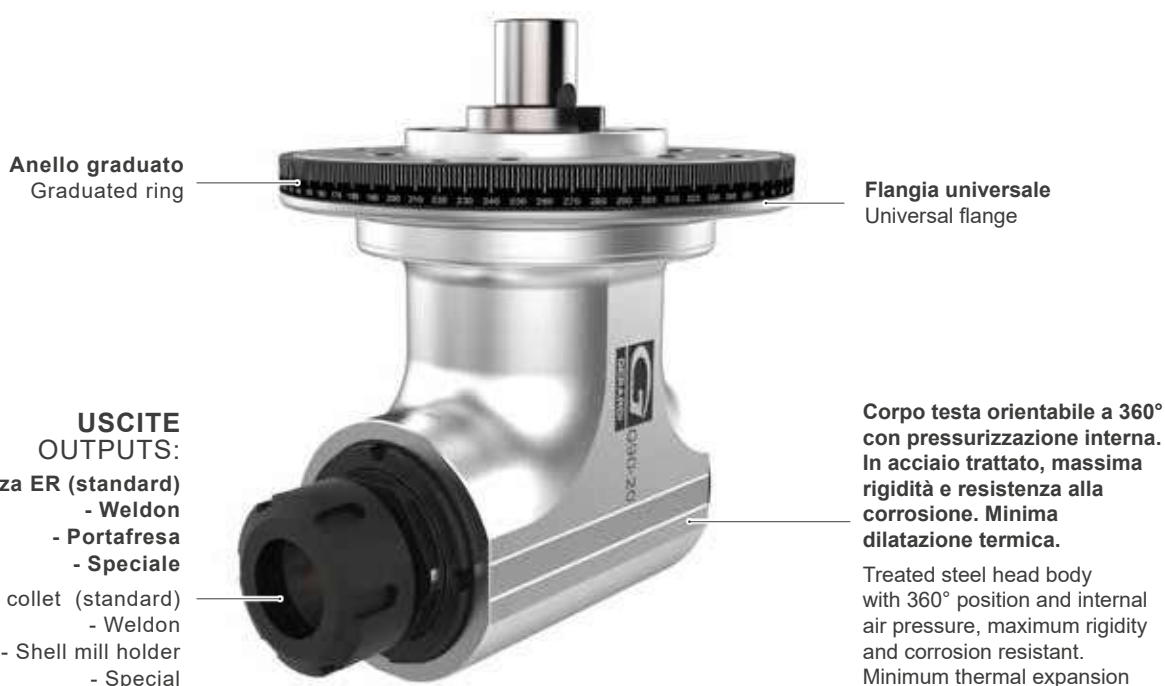

PROLUNGHE - EXTENSIONS

Sulla serie di teste MTC è possibile variare la lunghezza del corpo aggiungendo il modulo di prolunga (pag.1.95)

On MTC series is possible to extend the length of the body by adding an extension (pag.1.95)



Massimo 2 elementi di prolunga ammessi - Max. 2 extensions admitted.