

G90-16L 2U

TYPE 1

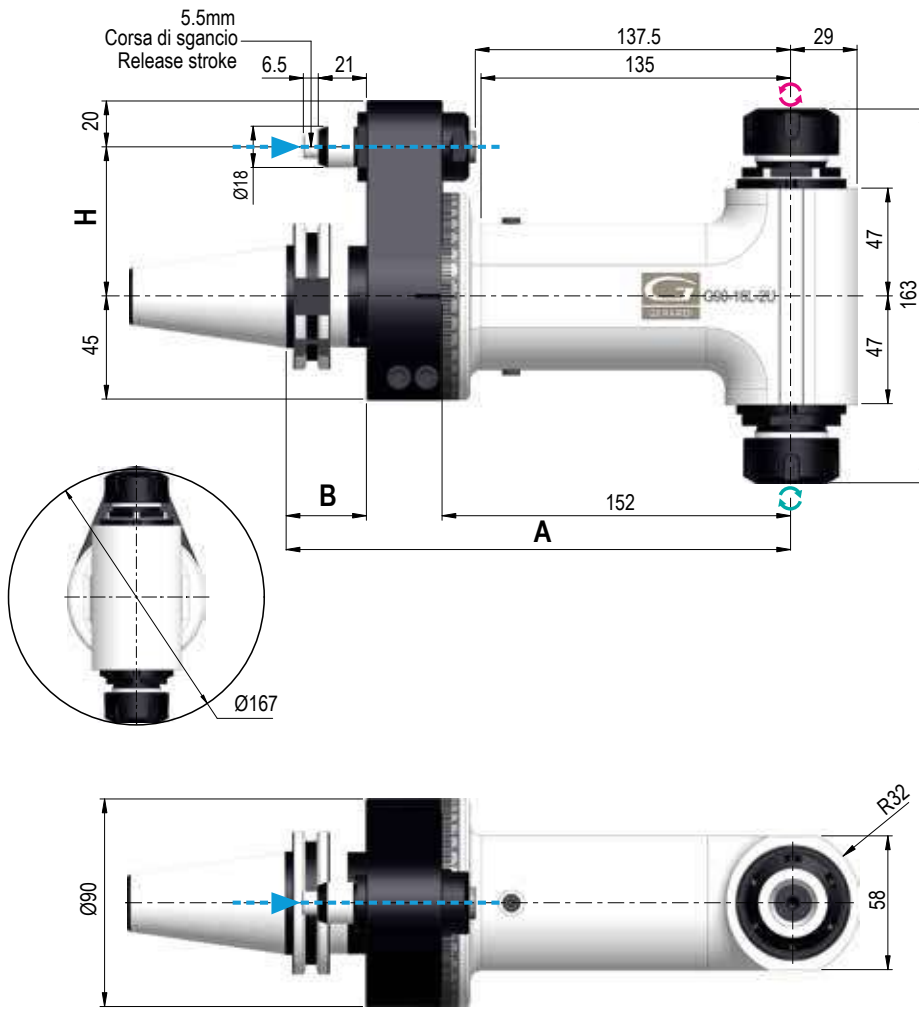

Dati tecnici - Technical data

	Ratio 1:1		Kg 13
	Rpm 4.000		Ø 16
	N 510		M 12
	Nm 24		ER25 Ø1/16

Senso di rotazione UguaLe e Contrario al mandrino - Direction of rotation Same & Opposite to the machine spindle

Coni - Shanks	SK DIN 69871		CAT ANSI B5.50		BT MAS 403		HSK DIN 69893			C. ISO 26623		
Grandezza - Size	40	50	40	50	40	50	63	80	100	C5	C6	C8
Dual contact (Optional)												
H Standard	65 / 80	80	65 / 80	80	65 / 80	80	65 / 80	65 / 80	80	65 / 80	65 / 80	80
Optional 110												
A	220	220	220	220	220	226	227	227	230	223	223	225
B	35	35	35	35	35	41	42	42	45	39	39	40

IMBALLO & PESO - PACK WEIGHT:

Cassa in Legno - Wooden Box 27Kg



DOTAZIONE STANDARD - STANDARD EQUIPMENT

Cassa in Legno / Stop block / Ghiera ER / Chiavi di servizio
Tubetto di grasso / Libro istruzioni

Wooden Box / Stop block / ER nut / Wrenches / Grease tube / Instruction book

OPZIONI - OPTIONS

HIGH SPEED - 8000 Rpm

OUTPUT - Weldon Max Ø16 (X2)

OUTPUT - Shell mill holder Ø16 (X2)

Teste Angolari / Angle Heads

CLASSIC LINE



Velocità / High-speed
10.000 Rpm



Internal coolant
fino a / Up to
70Bar

Cono e Albero Integrati - Integral Shank & Shaft !

from 1.10 to 1.54

SERIE ATC / ATC SERIES

E' la linea di teste adatte ai centri di lavoro, trasportabile automaticamente dal magazzino utensili al mandrino e viceversa. Corpo testa orientabile di 360° su ASSE MANDRINO. Quando la testa non è in posizione di lavoro, un sistema di aggancio impedisce la rotazione del cono rispetto al corpo testa. Una caratteristica primaria delle teste Classic - ATC è l'albero centrale realizzato in un solo pezzo con il cono di attacco, per offrire la massima rigidità. Recentissima novità è il perno di fermo intercambiabile.

This range of heads is designed to be used on machining centres and can be automatically transferred from the tool magazine to the machine spindle and back. Angle head body adjustable at 360° on SPINDLE AXIS. This allows easy adjustment of the drive taper and head relative to arresster block mounted on the front of the machining centres' spindle housing. When the head is unloaded from the machine spindle, a safety latch prevents the drive taper from rotating. A major feature of the Classic ATC heads is the main input shaft which is integral with the drive taper to ensure maximum rigidity. The last news is the interchangeable positioning pin.

from 1.57 to 1.88

SERIE MTC / MTC SERIES

E' la linea di teste adatte a macchine utensili tradizionali e da fissare al mandrino tramite flangiatura. La cava a "T" ricavata sulla flangia universale permette un facile posizionamento del corpo testa sui 360° intorno al suo asse verticale. Un sistema modulare componibile, rende possibile variare la lunghezza del corpo testa aggiungendo l'elemento di prolunga. Modulo di prolunga, coni e flangia universale sono modulari e quindi intercambiabili su tutti i corpi testa appartenenti allo stesso ordine di grandezza.

This is a range of heads for traditional machine tools with flange attachment. The T-slot on the universal flange facilitates positioning the head 360° around its vertical axis. The modular system makes it possible to extend the length of the body by adding a spacer. The extension spacer, drive tapers and universal flange are modular and therefore interchangeable among all the heads of similar size.



Albero & Cono Integrale Integral Shank & Shaft

Albero con cono di attacco integrale (cementato, temprato e rettificato) per garantire la massima rigidità. Intercambiabili per un utilizzo su più centri di lavoro.

Main shaft is one solid piece with the drive input taper, case hardened and ground, to ensure maximum rigidity. They are interchangeable to fit any machine spindle



Cuscinetti ABEC 9 ABEC 9 Ball Bearings

Ciascun albero di trasmissione è supportato da una coppia di cuscinetti a contatto obliquo, precaricati in classe di precisione ABEC 9 e lubrificati con grasso a vita

Shafts supported by sets of super precision pre-loaded angular contact bearings with Long Life grease lubrication and ABEC 9 accuracy rating



Corpo Principale Main Body

Corpo testa orientabile a 360° con pressurizzazione interna. In acciaio trattato, massima rigidità e resistenza alla corrosione. Minima dilatazione termica

Treated steel head body with 360° position and internal air pressure, maximum rigidity and corrosion resistant. Minimum thermal expansion



Ingranaggi Gleason Gleason Gears

Ingranaggi conici spiroidali in materiale ad alta resistenza, rettificati per garantire minore riscaldamento e rumorosità ed elevato numero di giri. Calcolo computerizzato della coppia conica degli ingranaggi (gleason): più denti in presa, più coppia in uscita, maggior numero di ore di lavorazione, rumorosità quasi assente.

Ground spiral bevel gears in the highest performance materials able to guaranteed less warming and noise and the highest Rpm. Computerized computation of the data of the set gears more than one tooth working during mesh, more power transmitted, longer gear life, almost no noise

In continuo sviluppo, la gamma di teste Classic Line, è oggi composta da 252 modelli completamente compatibili con la Linea Evolution e con qualunque macchina sul mercato grazie all'ampia gamma di coni disponibili. L'obiettivo è sempre lo stesso: Ottimizzare i cicli, semplificare e migliorare sempre di più la qualità di qualsiasi tipo di lavorazione su centri orizzontali & verticali. Le Teste Angolari Gerardi della linea Classic nascono da solide basi tecniche e dall'esperienza maturata da oltre 50 anni trascorsi al fianco dei nostri clienti durante i quali abbiamo risolto i problemi più variegati cercando la soluzione migliore e garantendo sempre l'elevata qualità ed affidabilità dei nostri prodotti.

The Classic Line Angle Heads range is constantly evolving and it currently consists of 252 items, all compatible with both Evolution Line Angle Heads and all machining centres on the market thanks to the wide range of shanks available. Our goal is always the same: optimizing the production chain by simplifying and improving more and more every type of operation on horizontal and vertical machining centres. The new Classic line of Gerardi angle heads has been designed from a technical base derived from more than 50-years-experience in solving thousands of production problems, finding optimum solutions and always guaranteeing the highest product quality.

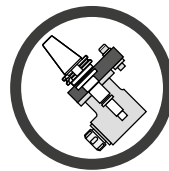

SCAN IT TO SEE



THE WEB PAGE



Linea di teste angolari integrali! Integral angle heads series!

Uscite regolabili GMU GMU Adjustable output

Operazioni orizzontali, verticali e angolari con una sola testa. Uscita completamente regolabile con angolazione $\pm 90^\circ$

Vertical, horizontal and angular machining operations with one angle head only. Fully adjustable output $\pm 90^\circ$



Refrigerante 10BAR
attraverso il perno
Standard 10BAR
coolant through the pin



Manipoli ad Angolo
90° Angle Spindle



PASSAGGIO REFRIGERANTE - COOLANT TYPES:



10bar

- » Perno
- » Utensile
- » Positioning pin
- » Tool



10bar

- » Perno
- » Distributore
- » Utensile
- » Positioning Pin
- » Rotating Distributor
- » Tool



up to
70bar

- » Cono
- » Distributore
- » Utensile
- » Shank
- » Rotating Distributor
- » Tool



up to
150bar

- » Perno
- » Ghiera ReCool
- » Utensile
- » Positioning Pin
- » ReCool Nut
- » Tool

1

Novità / News

Classic Line

Nuovi Modelli di Teste Angolari Integrali

New Types of Integral Angle Heads



MINI90° SERIES

La nuova serie di teste angolari con manipolo ad angolo intercambiabile per lavorazioni con utensile da Ø1,6 a Ø3
New series of angle heads with interchangeable angle spindle for machinings with Ø1,6 to Ø 3



EXTENDED SERIES

La serie di teste angolari EXTRA LUNGHE con torretta riportata.
New EXTENDED series angle heads with reported turret.



SLIM SERIES

Nuovo modello di testa standard a 90° per MICRO lavorazioni in ingombri minimi
New standard 90° head type for MICRO machining in minimum overall spaces



OFFSET SERIES

Nuova gamma di teste disassate con refrigerante interno fino a 70bar.
New offset heads range with internal coolant up to 70 bar.

Esempi applicativi / Applications examples

Linea Classic

Teste angolari integrali serie ATC (Cambio utensile automatico)

Integral angle heads ATC series (Automatic tool change)



MINI90° SERIES

La nuova serie di teste angolari con manípolo ad angolo intercambiabile per lavorazioni in ingombri minimi
New series of angle heads with interchangeable angle spindle for machining in minimum overall spaces



EXTENDED SERIES

La serie di teste con torretta riportata ideale per fresature, forature e maschiature in profondità.
The angle head series with reported turret for deep milling, drilling and tapping.



COOLANT SERIES

La serie di teste angolari con passaggio refrigerante diretto dal mandrino, uscita utensile fino a 70bar
Angle heads series with coolant input directly from machine spindle and output through the tool up to 70bar



GMU SERIES

La serie di teste angolari con angolazione regolabile da 0 a 90°. Spina di posizionamento rapido (Step 15°)
Angle heads series with adjustable angle from 0 to 90°. Quick positioning pin (Step 15°)



DOUBLE SERIES

La serie di teste angolari ideali per fresature, forature e maschiature attraverso 2 mandrini contrapposti di 180°
Angle Heads series for milling drilling and tapping through 2 opposite outputs











OFFSET SERIES









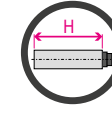
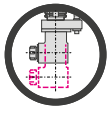

Testa angolari disassate per lavorazioni in spazi ristretti con opzione passaggio refrigerante dal cono, uscita utensile 70 BAR
Offset series for machining in narrow spaces with coolant input directly from machine spindle and output through the tool at 70 BAR

1

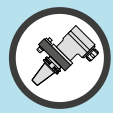
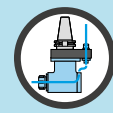
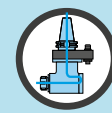
SIMBOLOGIA DATI TECNICI TECHNICAL DATA LOGOS

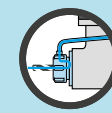
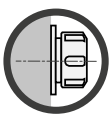
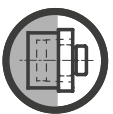
							
Rapporto trasmissione Ratio	Numero di giri Revolutions per minute Rpm	Carico assiale Axial load N	Coppia Torque Nm	Peso Weight Kg	Uscita Output Ø	Maschio Tapping M	Pinza Collet Ø

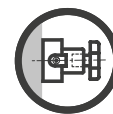
INDICE OPZIONI OPTIONS INDEX

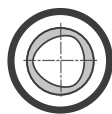
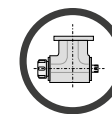
OPZIONI OPTIONS							
	Manipolo ad angolo Angular chuck	Alta velocità High speed	Spina per posizionamento rapido Quick positioning pin	Prolunga per manipolo ad angolo Extension for angular chuck	Lunghezze speciali Special lenght	Flangia Multipoint Multipoint flange	
PASSAGGIO REFRIGERANTE COOLANT							
	Attaverso il perno Through the Pin 10bar (standard) ROTAZ. a SECCO DRY RUNNING ✓	Perno » Distrib » Utensile Pin » Distributor » Tool 10bar ROTAZ. a SECCO DRY RUNNING ✓	Cono » Distrib » Utensile Shank » Distributor » Tool 30 / 40 / 70bar ROTAZ. a SECCO DRY RUNNING NO	Distributore » Utensile Distributor » Tool 10bar ROTAZ. a SECCO DRY RUNNING ✓	Perno » Ghiera » Utensile Pin » Distrib » Tool ReCool NUT		
USCITA OUTPUT							
	Uscita ER ER output	Uscita HSK HSK output	Uscita ISO ISO output	Uscita portafresa Shell mill holder output	Uscita WELDON WELDON output	Uscita C. C. output	Doppia uscita Double output

ATC SERIES

AUTOMATIC TOOL CHANGE



INGRANAGGI - GEARS

Ingranaggi Gleason con evolvente rettificato massime performances e minori vibrazioni

Gleason ground spiral bevel gears maximum performances and minimum vibration



STOP BLOCK

Con bussola cementata e guarnizione

With case hardened bushing and gasket



CUSCINETTI - BEARINGS

Cuscinetti a sfera a contatto obliquo in classe di precisione ABEC 9

Angular contact preloaded ball bearings of precision class ABEC 9

DESIGN

Il Design compatto, insieme alle specifiche descritte, consente: alte performances, elevate velocità, lunga durata degli utensili.

The Compact design, along with mentioned specifications, allows: highest performances, high speeds, long tools life

Albero integrale con cono cementato, temprato, rettificato

Integral case hardened and ground shank and shaft

Gruppo antirotante modulare
Modular antirotation group

Anello graduato
Graduated ring

USCITE - OUTPUTS:

- Portapinza ER (standard)
- Weldon
- Portafresa
- Speciale
- ER collet (standard)
- Weldon
- Shell mill holder
- Special



Perno di riferimento con sbloccaggio automatico del porta utensile

Positioning pin with automatic tool release

Passaggio refrigerante 10BAR attraverso il perno

Standard 10BAR coolant through the pin

Corpo testa orientabile a 360° con pressurizzazione interna.

In acciaio trattato, massima rigidità e resistenza alla corrosione.

Minima dilatazione termica.

Treated steel head body with 360° position and internal air pressure, maximum rigidity and corrosion resistant.

Minimum thermal expansion.

Ciascun albero di trasmissione supportato da cuscinetti a contatto obliquo, che garantiscono rotazioni dell'albero-cono e dell'uscita portautensile entro 0,01 mm
Each transmission shaft is supported by slanting bearings that ensure the shaft with shank and the toolholder output rotations within 0,01mm.